

# User Manual



## **Commander RT 1100/2000/3000 VA Line Interactive Sinewave UPS**

Uninterruptible Power Supply System

**IMPORTANT**  
Download latest software

[www.powershield.com.au/downloads](http://www.powershield.com.au/downloads)

NetGuard®

[www.powershield.com.au](http://www.powershield.com.au)

# Introduction

Thank you for choosing PowerShield.

PowerShield Commander RT UPS series are designed to provide the highest level of protection against disturbances found on electrical power supply lines. It is suitable for most applications including IT, security, telephone, broadcasting, medical etc.

The Commander UPS series are designed to provide the most comprehensive protection for your valuable electronic equipment, hardware, software and data from harmful disturbances found on AC power lines including blackouts, power sags, power surges, under voltage, over voltage, line noise, frequency variation, switching transients and harmonic distortions. The Commander RTs will continuously protect your equipment by internally isolating your equipment from the utility power ensuring that all your equipment always receives clean, uninterrupted and stable power.

## **Very Important !! : WARRANTY REGISTRATION**

In order to validate product warranty, it is essential that you register your UPS on line.

Please Visit PowerShield on line product warranty web page

**[www.powershield.com.au/product-registration.php](http://www.powershield.com.au/product-registration.php)**

This user manual contains instructions relating to safety, installation, operation, maintenance and warranty of this product.

Please keep this manual in a safe place for future references.

## Special Symbols

The following are examples of symbols used on the UPS to alert you the important information.

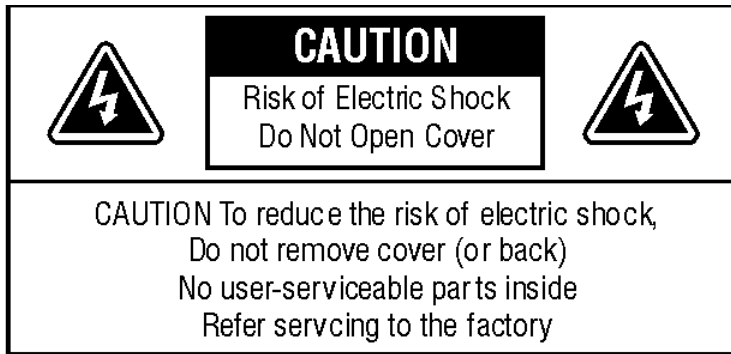

### **RISK OF ELECTRIC SHOCK -**

Indicates that a risk of electric shock is present and the associated warning should be observed



### **CAUTION; REFER TO OPERATOR'S MANUAL -**

Refer to your operator's manual for additional information, such as important operating and maintenance.



### **SAFETY EARTHING TERMINAL -**

Indicates the primary safety ground.

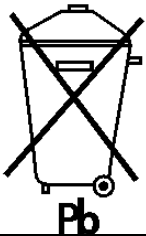

This symbol indicates that you should not discard the UPS or the UPS batteries in the trash. The UPS may contain sealed, lead-acid batteries. Batteries must be recycled.

# Table of Contents

1.  Important Safety Warning .....	4
1-1. Transportation .....	4
1-2. Preparation .....	4
1-3. Installation .....	4
1-4. Operation .....	5
1-5. Maintenance, service and faults .....	5
2. Installation And Setup .....	6
2-1. Rear Panel View .....	6
2-2. Installation of the UPS .....	7
2-3. Setup the UPS .....	7
3. Operations .....	10
3-1. Button Operation .....	10
3-2. LCD Panel .....	10
3-3. Audible Alarm .....	11
3-4. LCD Display Wordings Index .....	12
3-5. UPS Setting .....	12
3-6. Operating Mode Description .....	15
3-7. Faults Reference Code .....	16
3-8. Warning Indicator .....	16
4. Troubleshooting .....	17
4-1. Battery Replacement .....	18
4-2. Battery Kit Assembly (option) .....	19
5. Service .....	21
6. Storage and Maintenance .....	22
6-1. Operation .....	22
6-2. Storage .....	22
7. Contacting PowerShield .....	22
8. Specifications .....	23

## 1. Important Safety Warning

Please comply with all warnings and operating instructions in this manual. Save this manual properly and read carefully the following instructions before installing the unit. Do not operate this unit before reading through all safety information and operating instructions carefully

### 1-1. Transportation

- Please transport the UPS system only in the original package to protect against shock and impact.
- **Handling Safety**



Do not lift heavy loads without assistance.



<18 kg



18–32 kg



32–55 kg



>55 kg

This equipment is intended for installation in a controlled temperature indoor area free from conductive contaminants.

### 1-2. Preparation

- Condensation may occur if the UPS system is moved directly from cold to warm environment. The UPS system must be absolutely dry before being installed. Please allow at least two hours for the UPS system to acclimate to the environment.
- Do not install the UPS system near water or in moist environments.
- Do not install the UPS system where it would be exposed to direct sunlight or near heater.
- Do not block ventilation holes in the UPS housing.

### 1-3. Installation

- Do not connect appliances or devices which would overload the UPS system (e.g. laser printers) to the UPS output sockets.
- Place cables in such a way that no one can step on or trip over them.
- Do not connect domestic appliances such as hair dryers to UPS output sockets.
- **The UPS can be operated by any individuals with no previous experience.**
- Connect the UPS system only to an earthed shockproof outlet which must be easily accessible and close to the UPS system.
- Please use only VDE-tested, CE-marked mains cable (e.g. the mains cable of your computer) to connect the UPS system to the building wiring outlet (shockproof outlet).
- Please use only VDE-tested, CE-marked power cables to connect the loads to the UPS system.
- Pluggable equipment includes a protective earth conductor that carries the leakage current from the load devices ( computer equipment ). Total leakage current must not exceed 3.5mA.

## 1-4. Operation

- Do not disconnect the mains cable on the UPS system or the building wiring outlet (shockproof socket outlet) during operations since this would cancel the protective earthing of the UPS system and of all connected loads.
- The UPS system features its own, internal current source (batteries). The UPS output sockets or output terminals block may be electrically live even if the UPS system is not connected to the building wiring outlet.
- In order to fully disconnect the UPS system, first press the OFF/Enter button to disconnect the mains.
- Prevent no fluids or other foreign objects from inside of the UPS system.

## 1-5. Maintenance, service and faults

- The UPS system operates with hazardous voltages. Repairs may be carried out only by qualified maintenance personnel.
- **Caution** - risk of electric shock. Even after the unit is disconnected from the mains (building wiring outlet), components inside the UPS system are still connected to the battery and electrically live and dangerous.
- Before carrying out any kind of service and/or maintenance, disconnect the batteries and verify that no current is present and no hazardous voltage exists in the terminals of high capability capacitor such as BUS-capacitors.
- Only persons are adequately familiar with batteries and with the required precautionary measures may replace batteries and supervise operations. Unauthorized persons must be kept well away from the batteries.
- **Caution** - risk of electric shock. The battery circuit is not isolated from the input voltage. Hazardous voltages may occur between the battery terminals and the ground. Before touching, please verify that no voltage is present!
- Batteries may cause electric shock and have a high short-circuit current. Please take the precautionary measures specified below and any other measures necessary when working with batteries:
  - remove wristwatches, rings and other metal objects
  - use only tools with insulated grips and handles.
- When changing batteries, install the same number and same type of batteries.
- Do not attempt to dispose of batteries by burning them. This could cause battery explosion.
- Do not open or destroy batteries. Escaping electrolyte can cause injury to the skin and eyes. It is toxic.
- Please replace the fuse only with the same type and amperage in order to avoid fire hazards.
- Do not dismantle the UPS system.

## 2. Installation And Setup

**NOTE:** Before installation, please inspect the unit. Be sure that nothing inside the package is damaged. Please keep the original package in a safe place for future use.

### 2-1. Rear Panel View

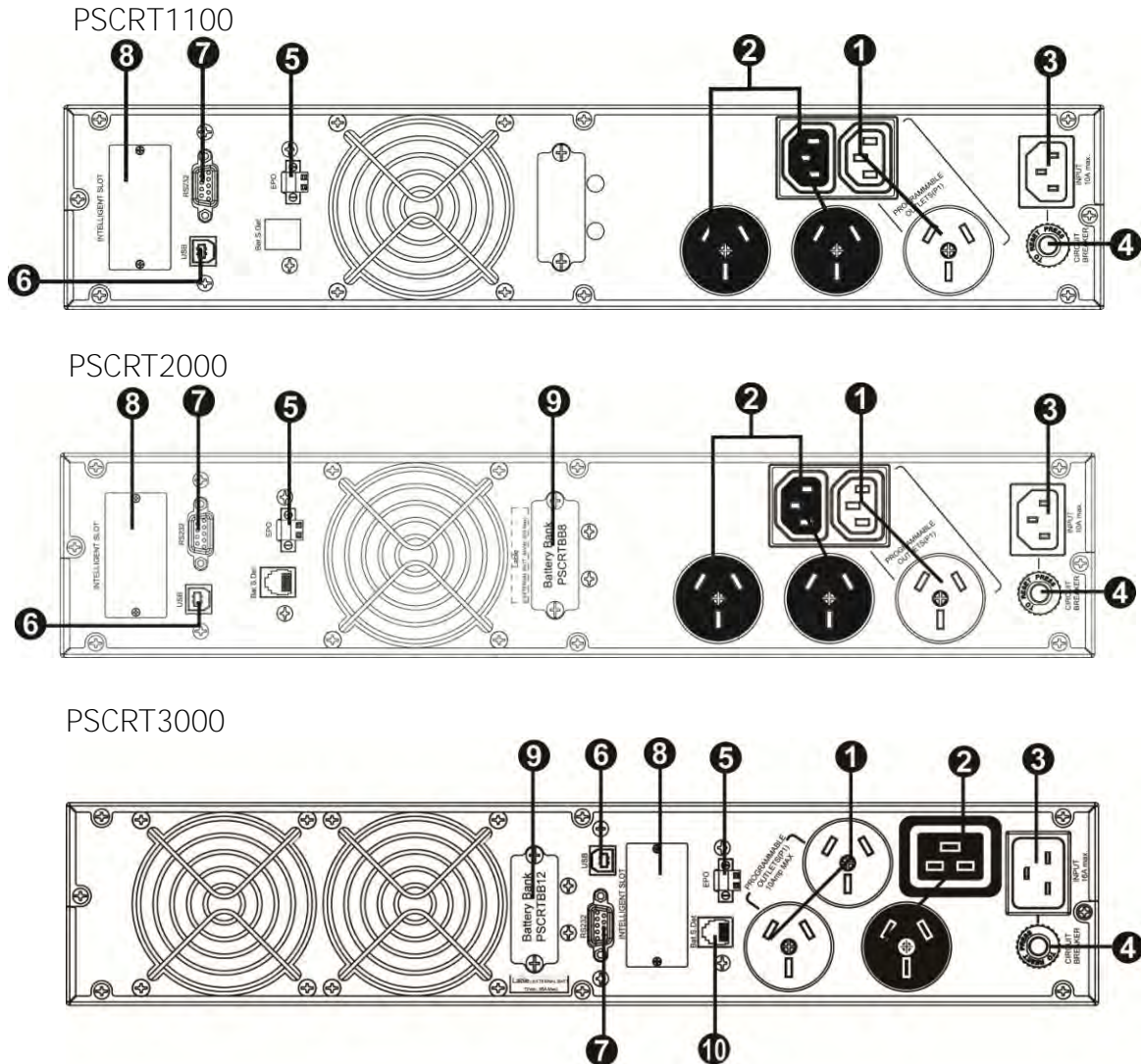

1. Programmable outlets: connect to non-critical loads.
2. Output receptacles: connect to mission-critical loads.
3. AC input
4. Input circuit breaker
5. Emergency power off function connector (EPO)
6. USB communication port
7. RS-232 communication port
8. SNMP intelligent slot
9. External battery connector (only available for 2000/3000 models)
10. External battery pack numbers detection port

## 2-2. Installation of the UPS

COMMANDER RT Series can be mounted vertically and horizontally. Please installation below for tower and rack mount installation steps.

### ● Rack-mount Installation

#### Step 1

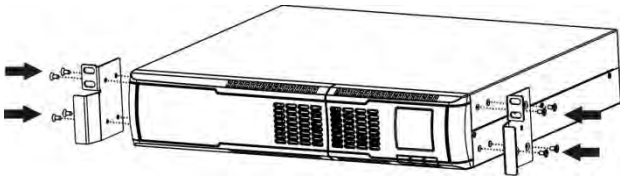

#### Step 2

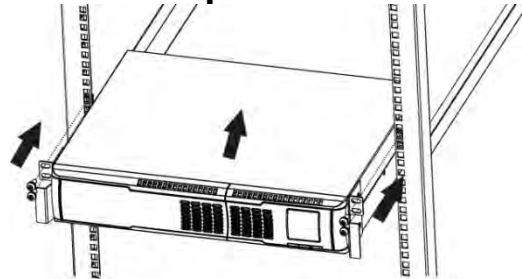

### ● Tower Installation

#### Step 1

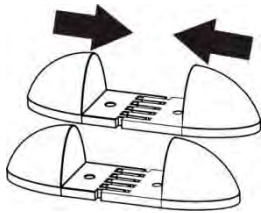

#### Step 2

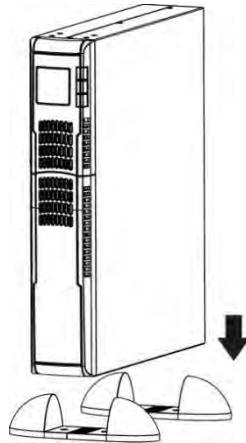

#### Step 3

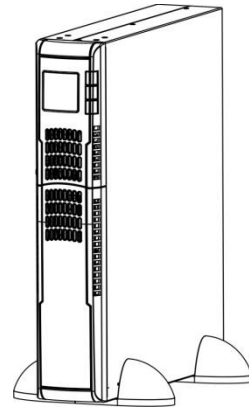

## 2-3. Setup the UPS

### Step 1: UPS input connection

Plug the UPS into a two-pole, three-wire, grounded receptacle only. Avoid using extension cords.

### Step 2: UPS output connection

There two kinds of outputs: programmable outlets( **white coloured outlets** )and general outlets ( **black coloured outlets** ).

Please connect **non-critical devices to the programmable outlets** and **critical devices to the general outlets.**

During power failure, you may extend the backup time to critical devices by setting shorter backup time for non-critical devices.



### Step 3: Communication connection

#### Interface ports:

##### USB port



##### RS-232 port

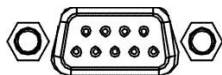

##### Intelligent slot



To allow for unattended UPS shutdown/start-up and status monitoring, connect the communication cable one end to the USB/RS-232 port and the other to the communication port of your PC. With the monitoring software installed, you can schedule UPS shutdown/start-up and monitor UPS status through PC.

The Commander RT series are equipped with intelligent slot perfect for either SNMP or AS400 card. When installing either SNMP or AS400 card in the UPS, it will provide advanced communication and monitoring options.

**NOTE : USB port and RS-232 port cannot work at the same time.**

### Step 5: EPO ( Emergency Power OFF ) function

Keep the pin 1 and pin 2 closed for UPS normal operation. To activate EPO function, cut the wire between pin 1 and pin 2.

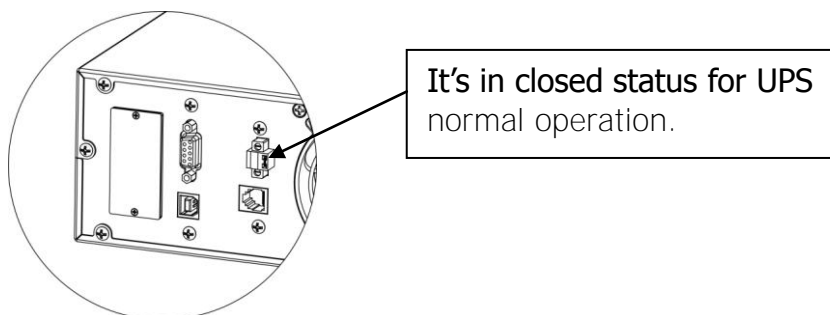

### Step 6: External battery connection (for Commander RT 2000 and 3000)

Connect one end of external battery cable to UPS unit and the other end to battery box. Use supplied battery detection wire in detection port of UPS unit and plug the other end to battery bank. See below chart for detailed connection.

Models : PSCRT2000,PSCRT3000

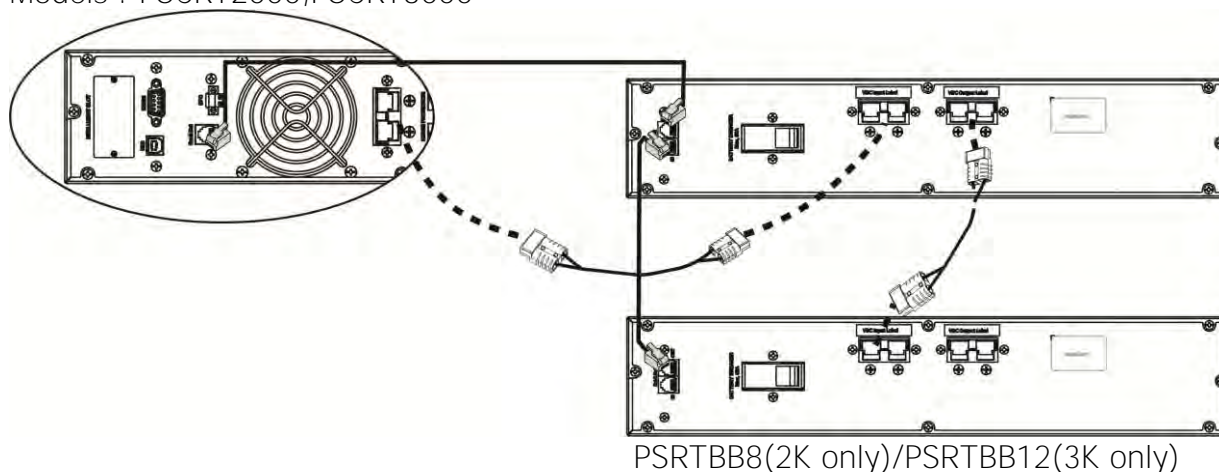

**NOTE:** Maximum connected external battery boxes up to 2 units.

## **Step 7: Turn on the UPS**

Press the ON/Mute button on the front panel for two seconds to power on the UPS.

**Note:** The battery charges fully during the first five hours of normal operation. Do not expect full battery run capability during this initial charge period.

## **Step 8: Install software**

Install NetGuard UPS monitoring software to fully configure UPS shutdown. Please follow steps below to download and install monitoring software:

1. Go to the website [\*\*http://www.powershield.com.au/downloads\*\*](http://www.powershield.com.au/downloads)
2. Click NetGuard software icon and then choose your required OS to download the software.
3. Follow the on-screen instructions to install the software.
4. When your computer restarts, the monitoring software will appear as an orange plug icon located in the system tray, near the clock.

### 3. Operations

#### 3-1. Button Operation

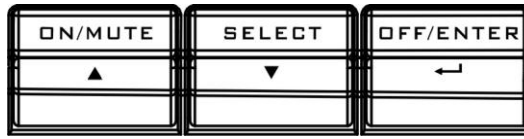

Button	Function
ON/MUTE Button	<ul style="list-style-type: none"> <li>➤ Turn on the UPS: Press and hold ON/Mute button for at least 2 seconds to turn on the UPS.</li> <li>➤ Mute the alarm: After the UPS is turned on in battery mode, press and hold this button for at least 5 seconds to disable or enable the alarm system. <b>But it's not applied to the situations when warnings or errors occur.</b></li> <li>➤ Up key: Press this button to display previous selection in UPS setting mode.</li> <li>➤ Switch to UPS self-test mode: Press and hold ON/Mute button for 5 seconds to enter UPS self-testing while in AC mode</li> </ul>
OFF/ENTER Button	<ul style="list-style-type: none"> <li>➤ Turn off the UPS: Press and hold this button at least 2 seconds to turn off the UPS</li> <li>➤ Confirm selection key: Press this button to confirm selection in UPS setting mode.</li> </ul>
SELECT Button	<ul style="list-style-type: none"> <li>➤ Switch LCD message: Press this button to change the LCD message for input voltage, input frequency, battery voltage, output voltage and output frequency.</li> <li>➤ Setting mode: Press and hold this button for 5 seconds to enter UPS setting mode when UPS is off.</li> <li>➤ Down key: Press this button to display next selection in UPS setting mode.</li> </ul>

#### 3-2. LCD Panel



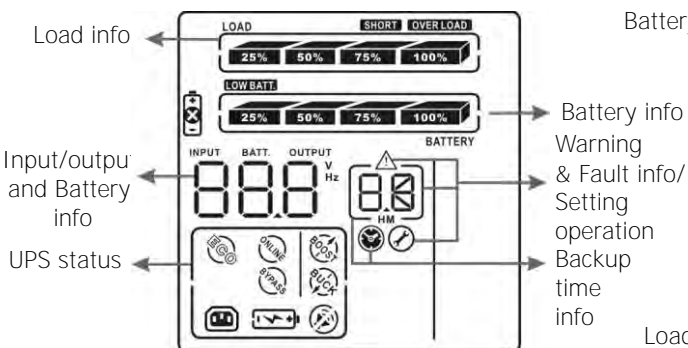



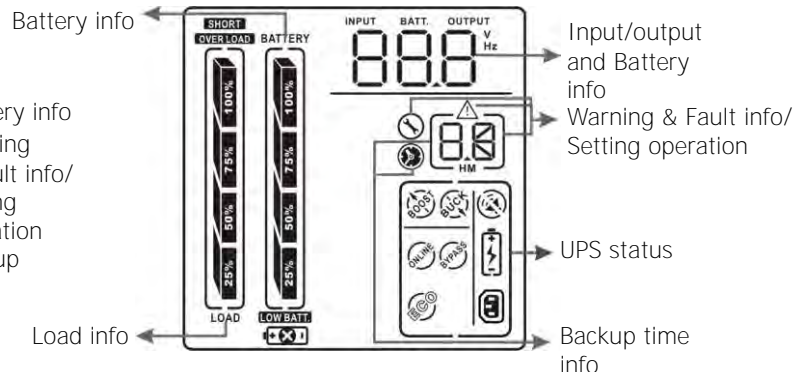







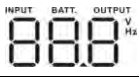



##### Rack Display



##### Tower Display



Display	Function
<b>Backup time information</b>	
	Indicates the backup time in pie chart.

	Indicates the backup time in numbers. H: hours, M: minute
<b>Warning &amp; Fault information</b>	
	Indicates that the warning and fault occurs.
	Indicates the warning and fault codes, and the codes are listed in details in 3-5 section.
<b>Setting Operation</b>	
	Indicates the setting operation.
<b>Input/Output &amp; Battery information</b>	
	Indicates the output/input voltage, output/input frequency or battery voltage. V: voltage, Hz: frequency
	Indication E01 is for one external battery bank , and E02 is for two/This is only for PSCRT2000 and PSCRT3000/
<b>Load information</b>	
	Indicates the load level by 0-25%, 26-50%, 51-75%, and 76-100%.
	Indicates overload.
	Indicates the load or the UPS output is short circuited.
<b>UPS status</b>	
	Indicates that programmable management outlets are working.
	Indicates that the UPS alarm is disabled.
	Indicates the UPS powers the output directly from the mains
	Indicates the battery charger is working.
	Indicates the UPS is working in boost mode
	Indicates the UPS is working in buck mode
<b>Battery information</b>	
	Indicates the Battery level by 0-25%, 26-50%, 51-75%, and 76-100%.
	Indicates low battery.
	Indicates there is something wrong with battery.

### 3-3. Audible Alarm

Battery Mode	2 beeps every 30 seconds
Low Battery	Rapid one beep every second
Overload	2 short beeps every 2 seconds
Fault	Continuously sounding

### 3-4. LCD Display Wordings Index

Abbreviation	Display content	Meaning
ENA	ENR	Enable
DIS	diS	Disable
ESC	ESC	Escape
EP	EP	EPO
TP	tP	Temperature
CH	CH	Charger
RAC	rAC	Rack display
TOE	tOE	Tower display
SF	SF	Site Fault

### 3-5. UPS Setting

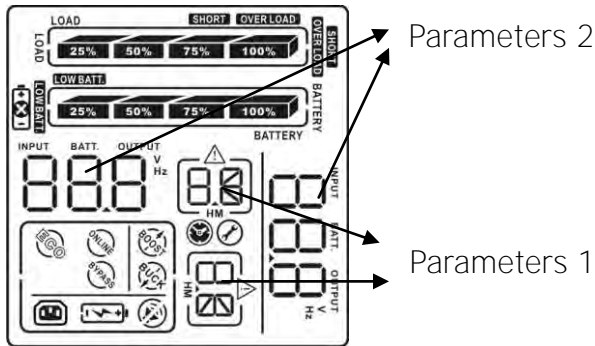

There are two parameters to set up the UPS.

**Parameter 1:** It's for program alternatives. There are 4 programs to set up: output voltage setting, programmable outlets enable/disable, programmable outlets setting, LCD display direction and exit.

- 01: Output voltage setting

Interface	Setting
	<p>For 208/220/230/240 VAC models, you may choose the following output voltage:</p> <p>208: presents output voltage is 208Vac                  220: presents output voltage is 220Vac                  230: presents output voltage is 230Vac                  240: presents output voltage is 240Vac (Default setting)</p>

- 02: Programmable outlets enable/disable

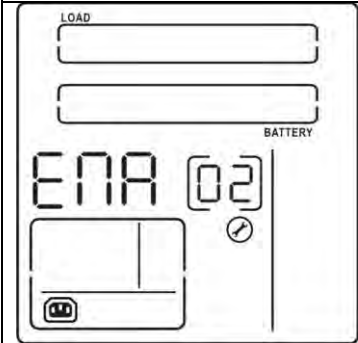
Interface	Setting
 <p>The LCD display shows 'ENA' on the left and '02' in a box on the right. Above the display are two horizontal bars labeled 'LOAD' and 'BATTERY'. Below the display is a small icon of a battery.</p>	<p>ENA: Programmable outlets enable DIS: Programmable outlets disable (Default setting)</p>

- 03: Programmable outlets setting

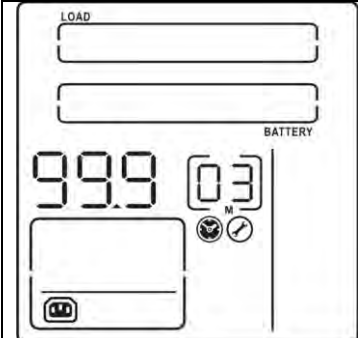
Interface	Setting
 <p>The LCD display shows '999' on the left and '03' in a box on the right. Above the display are two horizontal bars labeled 'LOAD' and 'BATTERY'. Below the display is a small icon of a battery.</p>	<p>Setting the backup time limits in minutes from 0-999 for programmable outlets which connect to non-critical devices on battery mode.</p>

- 04: LCD display direction setting

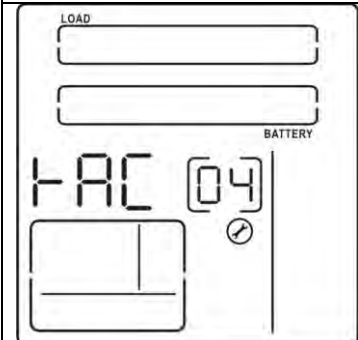
Interface	Setting
 <p>The LCD display shows 'HAC' on the left and '04' in a box on the right. Above the display are two horizontal bars labeled 'LOAD' and 'BATTERY'. Below the display is a small icon of a battery.</p>	<p>RAC: the LCD display is horizontal. TOE: the LCD display is vertical. (Default setting)</p>

- 05: LCD display backlight setting

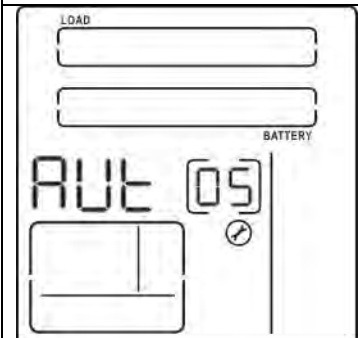
Interface	Setting
 <p>The LCD display shows 'AUT' on the left and '05' in a box on the right. Above the display are two horizontal bars labeled 'LOAD' and 'BATTERY'. Below the display is a small icon of a battery.</p>	<p>Aon: LCD display backlight is on all the time Aut: LCD display backlight will be off after pressing the buttons 60seconds. (Default setting)</p>

- 06: Input Waveform Sensitivity

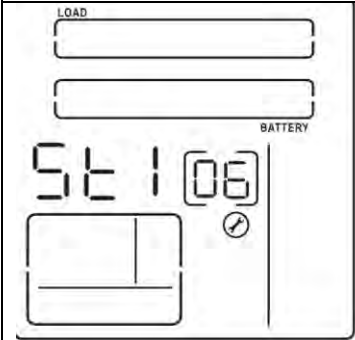
Interface	Setting
	<p>St1: Input voltage waveform detection is highly sensitive.            St2: Input voltage waveform detection is middle sensitive. (Default)            St3: Input voltage waveform detection is low sensitive.</p>

- 00: Exit setting

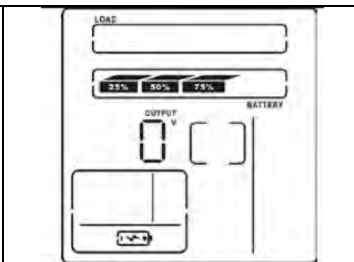
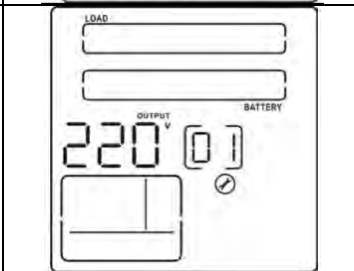
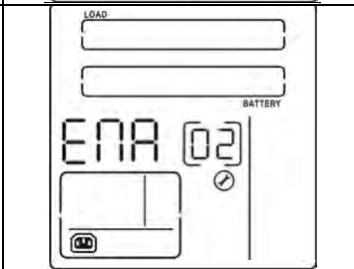
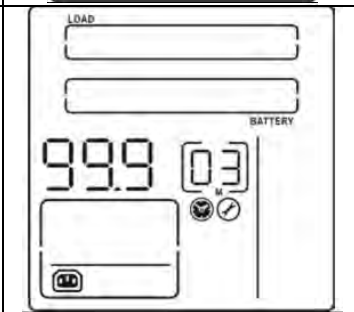

### Steps for setting programmable outlet ( White Coloured Outlets )

<p><b>Step 1:</b>            Before entering setting mode, the UPS should be in Stand-by mode (off-charging) and make sure the battery is connected. The LCD display is shown as right.</p>	
<p><b>Step 2:</b>            Press and hold the "Selection" button for 5 seconds to enter Setting mode.</p>	
<p><b>Step 3:</b>            Press the "Up" button (ON/MUTE) to switch to "02" of program list. Then press "Enter" button to enter value setting of parameter 2. Press the "Up" button to change the value to "ENA" to enable the programmable outlet function. Then press "Enter" button again to confirm the setting.</p>	
<p><b>Step 4:</b>            Press the "Up" button (ON/MUTE) again to switch to "03" of program list. Then press "Enter" button for setting programmable outlet time. Push "Up" button to change the value of backup time according your demand. Then press "Enter" to confirm the setting.</p>	
<p><b>Step 5:</b>            Press "Up" button (ON/MUTE) to switch to "00" of program list. Then press "Enter" button to exit setting menu.</p>	

**Step 6:**

Disconnect AC input and wait until the LCD display is off. The new setting will be activated when turning on the UPS again.

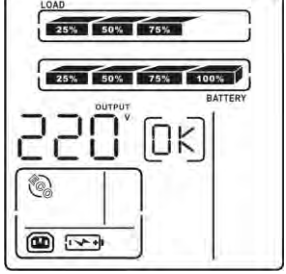
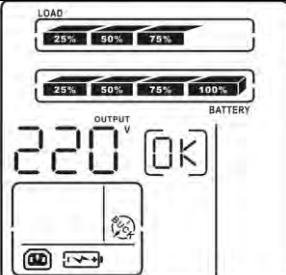
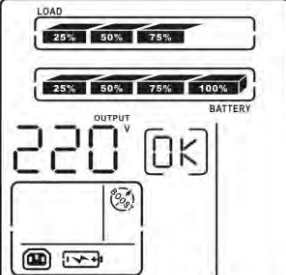
**3-6. Operating Mode Description**

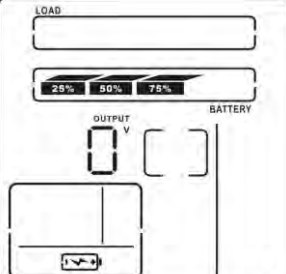





Operating mode	Description	LCD display
ECO mode	When the input voltage is within voltage regulated range, UPS will power the output directly from the mains. ECO is an abbreviation of <b><u>Efficiency Corrective Optimizer mode</u></b> . In this mode, when battery is fully charged, the fan will stop working for energy saving.	 <p>The LCD display shows two load bars (top and bottom) with 25%, 50%, and 75% markers. The output voltage is 220V and the status is OK. A battery icon is visible at the bottom left.</p>
Buck mode when AC is normal.	When the input voltage is higher than the voltage regulation range but lower than high loss point, the buck AVR will be activated.	 <p>The LCD display shows two load bars (top and bottom) with 25%, 50%, 75%, and 100% markers. The output voltage is 220V and the status is OK. A buck AVR icon is visible at the bottom right.</p>
Boost mode when AC is normal.	When the input voltage is lower than the voltage regulation range but higher than low loss point, the boost AVR will be activated.	 <p>The LCD display shows two load bars (top and bottom) with 25%, 50%, 75%, and 100% markers. The output voltage is 220V and the status is OK. A boost AVR icon is visible at the bottom right.</p>
Battery mode	When the input voltage is beyond the acceptable range or power failure and alarm is sounding <b>2 beeps every 30 seconds</b> , UPS will backup power from battery.	 <p>The LCD display shows two load bars (top and bottom) with 25% and 50% markers. The output voltage is 220V and the status is (18) M. A battery icon is visible at the bottom left.</p>
Standby mode	UPS is powered off and no output supply power, but still can charge batteries.	 <p>The LCD display shows two load bars (top and bottom) with 25%, 50%, and 75% markers. The output voltage is 0V. A battery icon is visible at the bottom left.</p>



### 3-7. Faults Reference Code



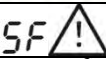
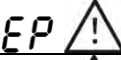
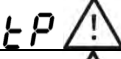



Fault event	Fault code	Icon	Fault event	Fault code	Icon
Bus start fail	01	x	Inverter output short	14	<b>SHORT</b>
Bus over	02	x	Battery voltage too high	27	x
Bus under	03	x	Battery voltage too low	28	
Inverter soft start fail	11	x	Over temperature	41	x
Inverter voltage high	12	x	Over load	43	<b>OVER LOAD</b>
Inverter voltage Low	13	x			

### 3-8. Warning Indicator

Warning	Icon (flashing)	Alarm
Low Battery		Rapid one beep every second
Overload		2 short beeps every 2 seconds
Battery is not connected		2 short beeps every 2 seconds
Overcharge		Continuously sounding
Site wiring fault		2 short beeps every 2 seconds
EPO enable		2 short beeps every 2 seconds
Over temperature		Continuously sounding
Charger failure		Continuously sounding
Battery Fault		Continuously sounding

## 4. Troubleshooting

If Commander RT series do not operate correctly, please solve the problem by using the table below.

Symptom	Possible cause	Remedy
No indication and alarm even though the mains is normal.	The AC input power is not connected well.	Check if input power cord firmly connected to the mains.
	The AC input is connected to the UPS output.	Plug AC input power cord to AC input correctly.
The icon  and the warning code <b>EP</b> flashing on LCD display and alarm is sounding 2 short beeps every 2 seconds	EPO function is activated.	Set the circuit in close position to disable EPO function.
The icon  and <b>SF</b> flashing on LCD display and alarm is sounding 2 short beeps every 2 seconds	Line and neutral conductors of UPS input are reversed.	Rotate mains power socket by 180° and then connect to UPS system.
The icon  and  flashing on LCD display and alarm is sounding 2 short beeps every 2 seconds	The external or internal battery is incorrectly connected.	Check if all batteries are connected well.
Fault code is shown as 27 and the icon  is lighting on LCD display and alarm is continuously sounding.	Battery voltage is too high or the charger is fault.	Contact your dealer.
Fault code is shown as 28 and the icon  is lighting on LCD display and alarm is continuously sounding.	Battery voltage is too low or the charger is fault.	Contact your dealer.
The icon  and the icon <b>OVER LOAD</b> are flashing on LCD display and alarm is sounding 2 short beeps every 2 seconds.	UPS is overload	Remove excess loads from UPS output.
Fault code is shown as 43 and The icon <b>OVER LOAD</b> is lighting on LCD display and alarm is continuously sounding.	The UPS shut down automatically because of overload at the UPS output.	Remove excess loads from UPS output and restart it.
Fault code is shown as 14 and alarm is continuously sounding.	The UPS shut down automatically because short circuit occurs on the UPS output.	Check output wiring and if connected devices are in short circuit status.

Symptom	Possible cause	Remedy
Fault code is shown as 01, 02, 03, 11, 12, 13 and 41 on LCD display and alarm is continuously sounding.	A UPS internal fault has occurred.	Contact your dealer
Battery backup time is shorter than nominal value	Batteries are not fully charged	Charge the batteries for at least 5 hours and then check capacity. If the problem still persists, consult your dealer.
	Batteries defect	Contact your dealer to replace the battery.

### 4-1. Battery Replacement

NOTICE: The Commander RT series are equipped with internal batteries and user can replace the batteries without shutting down the UPS or connected loads. (hot-swappable battery design) Replacement battery pack is a safe procedure and isolated from electrical hazards.

**CAUTION!!** Consider all warnings, cautions, and notes before replacing batteries.

**Note:** Upon battery disconnection, equipment is not protected from power outages.

#### Step 1

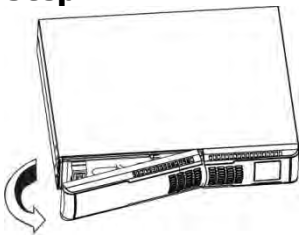

Remove front panel.

#### Step 2

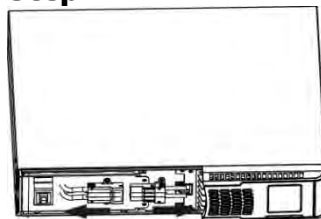

Disconnect battery wires.

#### Step 3

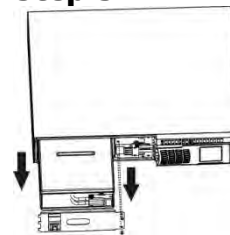

Pull out the battery box by removing two screws on the front panel.

#### Step 4

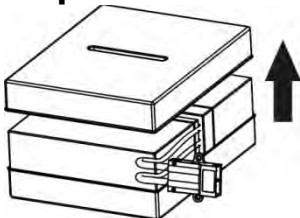

Remove the top cover of battery box and replace the inside batteries.

#### Step 5

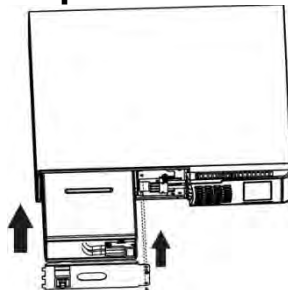

After replacing the batteries, put the battery box back to original location and screw it tightly.

#### Step 7

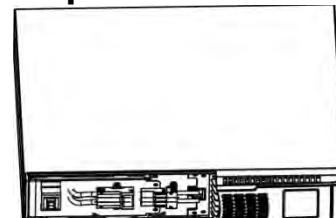

Re-connect the battery wires.

## Step 8

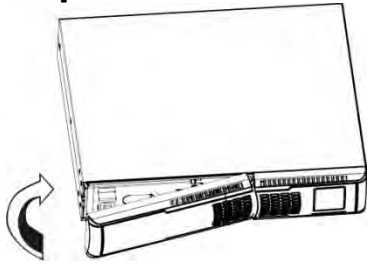

Put the front panel back to the unit.

## 4-2. Battery Kit Assembly (option)

**NOTE : We RECOMMEND TO USE POWERSHIELD CERTIFIED BATTERIES FOR ASSEMBLING YOUR OWN BATTERY PACK.**

**NOTICE:** Please assemble battery kit first before installing it inside of UPS. Please select correct battery kit procedure below to assemble it.

### Battery kit for PSCRT1100 Step 1:

Remove adhesive tapes.

Tapes

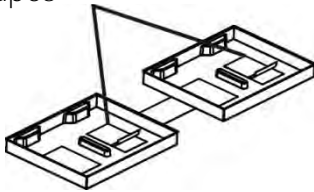

Step 2: Connect all battery terminals by following below chart.

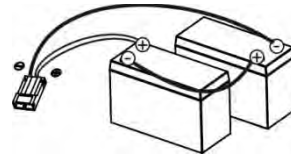

Step 3: Put assembled battery packs on one side of plastic shells and insert one more defect battery on the space.

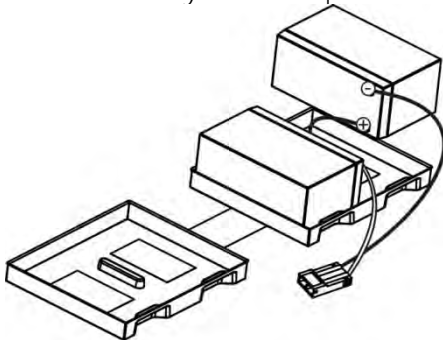

Step 4: Cover the other side of plastic shell as below chart. Then, battery kit is assembly well.

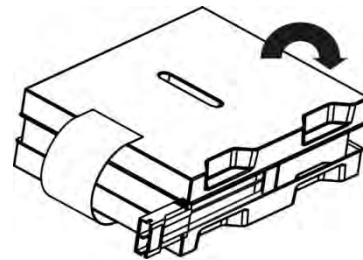

### Battery kit for PSCRT2000/PSRTBB8

Step 1: Remove adhesive tapes.

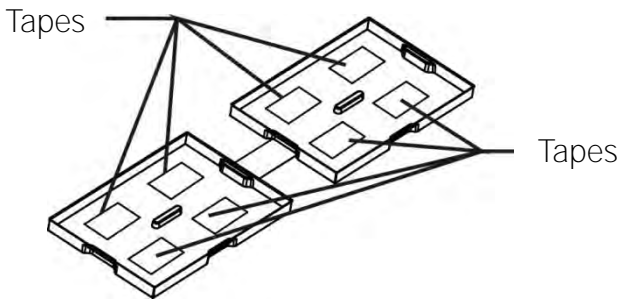

Step 2: Connect all battery terminals by following below chart.

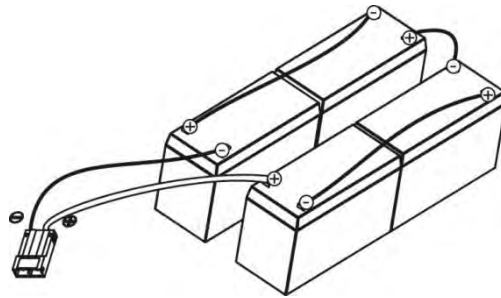

Step 3: Put assembled battery packs on one side of plastic shells.

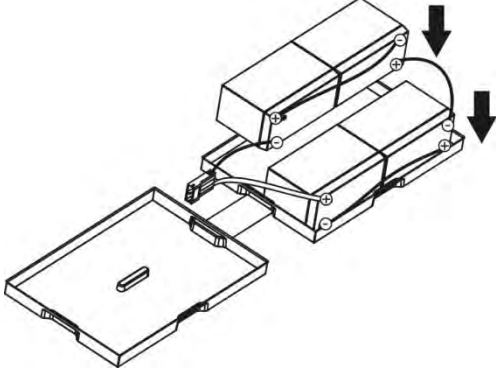

Step 4: Cover the other side of plastic shell as below chart. Then, battery kit is assembly well.

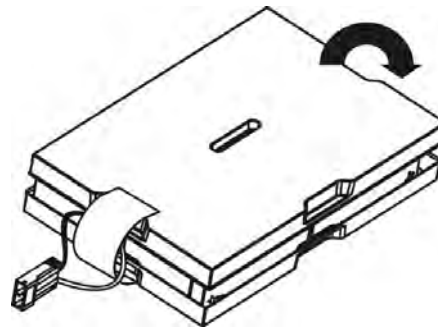

### Battery kit for PSCRT3000/PSRTBB12

Step 1: Remove adhesive tapes.

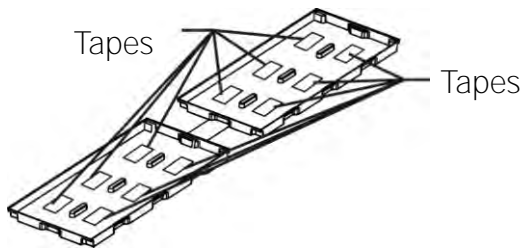

Step 2: Connect all battery terminals by following below chart.

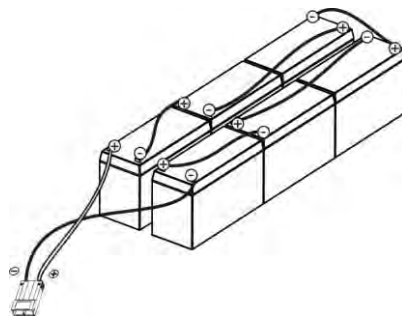

Step 3: Put assembled battery packs on one side of plastic shells.

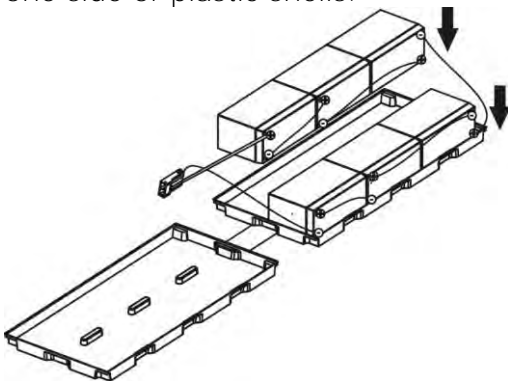

Step 4: Cover the other side of plastic shell as below chart. Then, battery kit is assembly well.

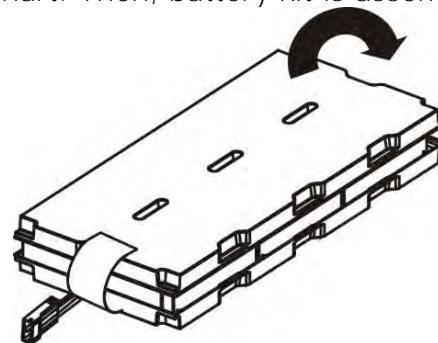

## 5. Service

### WARRANTY CONDITION:

The standard warranty is TWO (2) years from the date of purchase. The standard PowerShield procedure is to replace the original unit with a factory refurbished unit. PowerShield will ship the replacement unit once the defective unit has been received by the service department, or cross ship upon the receipt of a valid credit card number. The customer pays for shipping the defective unit to PowerShield. PowerShield pays ground freight transportation costs to ship the replacement to the customer within Australian capital cities metro areas only.

NOTE : For more information about our Warranty Policy, please visit our web site.

[www.powershield.com.au](http://www.powershield.com.au)

### WARRANTY SERVICE PROCESS :

1. Review the problems discussed in the troubleshoot section of this manual to eliminate common problems.
2. Verify that no input/output circuit breaker are tripped. A tripped circuit breaker is the most common problem.
3. If the problem still persists, please call 1300-305-393 for technical support or fill in the form in PowerShield web page for on line technical support.  
Following details are needed for warranty claims.
  - Model number
  - Serial number
  - The date of purchase
4. Be prepare to troubleshoot the problem over the phone with PowerShield technical support.
5. If technical support found that the product is defective, then the technical support will issue a Return Material Authorization Number ( RMA # )
6. If the unit is under warranty, repair is free. If not there is a repair charge.
7. Pack the unit in its original packaging. Pack properly to avoid damage during transit. Damage sustained in transit is not covered under warranty.
8. Mark the RMA # on the outside of the package.
9. Return the defective unit by insured, prepaid carrier to the address given to you by Technical support.

## 6. Storage and Maintenance

### 6-1. Operation

Commander RT series contains no user-serviceable parts. If the battery service life (3~5 years at 25°C ambient temperature) has been exceeded, the batteries must be replaced.

Please contact your dealer or visit PowerShield web site.

[www.powershield.com.au/support.php](http://www.powershield.com.au/support.php)



Be sure to deliver the spent battery to a recycling facility or ship it to your dealer in the replacement battery packing material.

### 6-2. Storage

Before storing, charge the UPS 5 hours. Store the UPS covered and upright in a cool, dry location. During storage, recharge the battery in accordance with the following table:

Storage Temperature	Recharge Frequency	Charging Duration
-25°C - 40°C	Every 3 months	1-2 hours
40°C - 45°C	Every 2 months	1-2 hours

## 7. Contacting PowerShield

Refer to the information provided at PowerShield internet site:

[www.powershield.com.au](http://www.powershield.com.au)

Or

Phone 1300 305 393

## 8. Specifications

COMMANDER RT				BATTERY BANKS		
Model	PSCRT1100	PSCRT2000	PSCRT3000	PSRTBB8	PSRTBB12	
Capacity	1100VA/880W	2000VA/1600W	3000VA/2400W	Suits PSCRT2000	Suits PSCRT3000	
Topology	Line Interactive, Pure Sine Wave					
<b>INPUT</b>						
Voltage	240Vac (Nominal)					
Voltage Range	162-290Vac					
Frequency Range	50/60Hz ±5Hz (Auto sensing)					
<b>OUTPUT</b>						
Output Voltage (AC Mode)	240Vac (Selectable 208/220/230Vac) ±10% AVR					
Voltage Regulation (Batt. Mode)	±3%					
Frequency Range (Batt. Mode)	50Hz or 60Hz ±1Hz					
Current Crest Ratio	3:1					
Transfer Time	6ms (Typical)					
Waveform (Batt. Mode)	Pure Sine Wave					
<b>EFFICIENCY</b>						
ECO Mode (Advanced)	98%	98%	98%			
Battery Mode	83%	89%	87%			
<b>BATTERY</b>						
Standard Model	Battery Type & Number	12 V*9AH (x 2)	12 V*9AH(x 4)	12 V*9AH (x 6)	12 V*9AH (x 8)	12 V*9AH (x 12)
	Typical Recharge Time	4 hours recover to 90% capacity				
Additional Battery Banks	N/A	PSRTBB8 (x1)	PSRTBB12 (x1)			
<b>PROTECTION</b>						
Full Protection	Overload, discharge, thermal, short circuit and overcharge protection					
Surge Protection	1560 Joules / 32500 Amps					
<b>COMMUNICATIONS &amp; MANAGEMENT</b>						
Interface	USB or RS232 as standard, Intelligent slot for PSSNMP, PSMdbus or PSAS400 dry contact					
Software	PowerShield NetGuard® software - supports Windows based operating systems, Linux, Unix and Mac					
LCD Display/Alarm	AC Mode, Batt.Mode, Load Level, Input Voltage, Output Voltage, Overload, Fault, Low Batt., Batt.Time Remaining					
Audible Alarm	Battery Mode, Low Battery (Batt. Mode), Fault, Overload					
<b>PHYSICAL</b>						
Dimension (D x W x H)	(380 x 438 x 88) mm		(600 x 438 x 88) mm	(380 x 438 x 88) mm	(600 x 438 x 88) mm	
Weight (Net/Gross)	(15kg/16kg)	(23kg/25kg)	(32kg/35kg)	(25kg/27kg)	(35kg/37kg)	
<b>OPERATING ENVIRONMENT</b>						
Temperature	0 - 40°C					
Humidity	0 - 90% (RH Non-condensing)					
Noise Level	< 45dB					
<b>COMPLIANCE</b>						
Safety	EN62040-1-1 2003, IEC60950-1-1					
EMC	EN62040-2 2006					
RoHS	Directive 2011/65/EU					

\* Derate capacity to 80% of capacity when the output voltage is adjusted to 208VAC.

\*\*Product specifications are subject to change without further notice.

Powershield Part #: 990-1100rev01