



REPUBLIC OF
GAMERS

ROG STRIX
XG258Q
GAMING MONITOR

ASUS

First Edition

June 2017

Copyright © 2017 ASUSTeK COMPUTER INC. All Rights Reserved.

No part of this manual, including the products and software described in it, may be reproduced, transmitted, transcribed, stored in a retrieval system, or translated into any language in any form or by any means, except documentation kept by the purchaser for backup purposes, without the express written permission of ASUSTeK COMPUTER INC. ("ASUS").

Product warranty or service will not be extended if: (1) the product is repaired, modified or altered, unless such repair, modification or alteration is authorized in writing by ASUS; or (2) the serial number of the product is defaced or missing.

ASUS PROVIDES THIS MANUAL "AS IS" WITHOUT WARRANTY OF ANY KIND, EITHER EXPRESS OR IMPLIED, INCLUDING BUT NOT LIMITED TO THE IMPLIED WARRANTIES OR CONDITIONS OF MERCHANTABILITY OR FITNESS FOR A PARTICULAR PURPOSE. IN NO EVENT SHALL ASUS, ITS DIRECTORS, OFFICERS, EMPLOYEES OR AGENTS BE LIABLE FOR ANY INDIRECT, SPECIAL, INCIDENTAL, OR CONSEQUENTIAL DAMAGES (INCLUDING DAMAGES FOR LOSS OF PROFITS, LOSS OF BUSINESS, LOSS OF USE OR DATA, INTERRUPTION OF BUSINESS AND THE LIKE), EVEN IF ASUS HAS BEEN ADVISED OF THE POSSIBILITY OF SUCH DAMAGES ARISING FROM ANY DEFECT OR ERROR IN THIS MANUAL OR PRODUCT.

SPECIFICATIONS AND INFORMATION CONTAINED IN THIS MANUAL ARE FURNISHED FOR INFORMATIONAL USE ONLY, AND ARE SUBJECT TO CHANGE AT ANY TIME WITHOUT NOTICE, AND SHOULD NOT BE CONSTRUED AS A COMMITMENT BY ASUS. ASUS ASSUMES NO RESPONSIBILITY OR LIABILITY FOR ANY ERRORS OR INACCURACIES THAT MAY APPEAR IN THIS MANUAL, INCLUDING THE PRODUCTS AND SOFTWARE DESCRIBED IN IT.

Products and corporate names appearing in this manual may or may not be registered trademarks or copyrights of their respective companies, and are used only for identification or explanation and to the owners' benefit, without intent to infringe.

Contents

Notices.....	iv
Safety information.....	v
Care & Cleaning.....	vi
Takeback Services.....	vii

Chapter 1: Product introduction

1.1	Welcome!	1-1
1.2	Package contents.....	1-1
1.3	Monitor introduction.....	1-2
1.3.1	Front/side view.....	1-2
1.3.2	Back view.....	1-3
1.3.3	GamePlus Function	1-4
1.3.4	GameVisual Function.....	1-5

Chapter 2: Setup

2.1	Assembling the monitor arm/base	2-1
2.2	Cable management	2-2
2.3	Adjusting the monitor.....	2-3
2.4	Detaching the arm (for VESA wall mount).....	2-4
2.5	Connecting the cables.....	2-5
2.6	Turning on the monitor.....	2-5

Chapter 3: General instructions

3.1	OSD (On-Screen Display) menu	3-1
3.1.1	How to reconfigure.....	3-1
3.1.2	OSD function introduction.....	3-1
3.2	Specifications summary	3-7
3.3	Troubleshooting (FAQ).....	3-8
3.4	Supported operating mode	3-9

Notices

Federal Communications Commission Statement

This device complies with Part 15 of the FCC Rules. Operation is subject to the following two conditions:

- This device may not cause harmful interference, and
- This device must accept any interference received including interference that may cause undesired operation.

This equipment has been tested and found to comply with the limits for a Class B digital device, pursuant to Part 15 of the FCC Rules. These limits are designed to provide reasonable protection against harmful interference in a residential installation. This equipment generates, uses and can radiate radio frequency energy and, if not installed and used in accordance with manufacturer's instructions, may cause harmful interference to radio communications. However, there is no guarantee that interference will not occur in a particular installation. If this equipment does cause harmful interference to radio or television reception, which can be determined by turning the equipment off and on, the user is encouraged to try to correct the interference by one or more of the following measures:

- Reorient or relocate the receiving antenna.
- Increase the separation between the equipment and receiver.
- Connect the equipment to an outlet on a circuit different from that to which the receiver is connected.
- Consult the dealer or an experienced radio/TV technician for help.



The use of shielded cables for connection of the monitor to the graphics card is required to assure compliance with FCC regulations. Changes or modifications to this unit not expressly approved by the party responsible for compliance could void the user's authority to operate this equipment.

Canadian Department of Communications Statement

This digital apparatus does not exceed the Class B limits for radio noise emissions from digital apparatus set out in the Radio Interference Regulations of the Canadian Department of Communications.

This class B digital apparatus complies with Canadian ICES-003.

This Class B digital apparatus meets all requirements of the Canadian Interference - Causing Equipment Regulations.

Cet appareil numérique de la classe B respecte toutes les exigences du Règlement sur le matériel brouiller du Canada.



Safety information

- Before setting up the monitor, carefully read all the documentation that came with the package.
- To prevent fire or shock hazard, never expose the monitor to rain or moisture.
- Never try to open the monitor cabinet. The dangerous high voltages inside the monitor may result in serious physical injury.
- If the power supply is broken, do not try to fix it by yourself. Contact a qualified service technician or your retailer.
- Before using the product, make sure all cables are correctly connected and the power cables are not damaged. If you detect any damage, contact your dealer immediately.
- Slots and openings on the back or top of the cabinet are provided for ventilation. Do not block these slots. Never place this product near or over a radiator or heat source unless proper ventilation is provided.
- The monitor should be operated only from the type of power source indicated on the label. If you are not sure of the type of power supply to your home, consult your dealer or local power company.
- Use the appropriate power plug which complies with your local power standard.
- Do not overload power strips and extension cords. Overloading can result in fire or electric shock.
- Avoid dust, humidity, and temperature extremes. Do not place the monitor in any area where it may become wet. Place the monitor on a stable surface.
- Unplug the unit during a lightning storm or if it will not be used for a long period of time. This will protect the monitor from damage due to power surges.
- Never push objects or spill liquid of any kind into the slots on the monitor cabinet.
- To ensure satisfactory operation, use the monitor only with UL listed computers which have appropriate configured receptacles marked between 100-240V AC.
- If you encounter technical problems with the monitor, contact a qualified service technician or your retailer.
- Adjustment of the volume control as well as the equalizer to other settings than the center position may increase the ear-/headphones output voltage and therefore the sound pressure level.
- The adapter is only used for this monitor, do not use it for other purpose.

Your device uses one of the following power supplies:

- Manufacturer: Delta Electronics Inc., Model: ADP-65GD B



This symbol of the crossed out wheeled bin indicates that the product (electrical, electronic equipment, and mercury-containing button cell battery) should not be placed in municipal waste. Please check local regulations for disposal of electronic products.

Care & Cleaning

- Before you lift or reposition your monitor, it is better to disconnect the cables and power cord. Follow the correct lifting techniques when positioning the monitor. When lifting or carrying the monitor, grasp the edges of the monitor. Do not lift the display by the stand or the cord.
- Cleaning. Turn your monitor off and unplug the power cord. Clean the monitor surface with a lint-free, non-abrasive cloth. Stubborn stains may be removed with a cloth dampened with mild cleaner.
- Avoid using a cleaner containing alcohol or acetone. Use a cleaner intended for use with the monitor. Never spray cleaner directly on the screen, as it may drip inside the monitor and cause an electric shock.

The following symptoms are normal with the monitor:

- The screen may flicker during the initial use due to the nature of the fluorescent light. Turn off the Power Switch and turn it on again to make sure that the flicker disappears.
- You may find slightly uneven brightness on the screen depending on the desktop pattern you use.
- When the same image is displayed for hours, an afterimage of the previous screen may remain after switching the image. The screen will recover slowly or you can turn off the Power Switch for hours.
- When the screen becomes black or flashes, or cannot work anymore, contact your dealer or service center to fix it. Do not repair the screen by yourself!

Conventions used in this guide



WARNING: Information to prevent injury to yourself when trying to complete a task.



CAUTION: Information to prevent damage to the components when trying to complete a task.



IMPORTANT: Information that you **MUST** follow to complete a task.



NOTE: Tips and additional information to aid in completing a task.

Where to find more information

Refer to the following sources for additional information and for product and software updates.

1. **ASUS websites**

The ASUS websites worldwide provide updated information on ASUS hardware and software products. Refer to <http://www.asus.com>

2. **Optional documentation**

Your product package may include optional documentation that may have been added by your dealer. These documents are not part of the standard package.

Takeback Services

ASUS recycling and takeback programs come from our commitment to the highest standards for protecting our environment. We believe in providing solutions for our customers to be able to responsibly recycle our products, batteries and other components as well as the packaging materials.

Please go to <http://csr.asus.com/english/Takeback.htm> for detail recycling information in different region.



1.1 Welcome!

Thank you for purchasing the ROG gaming monitor!

The latest widescreen LCD monitor from ASUS provides a broader, brighter and crystal-clear display, plus a host of features that enhance your viewing experience.

With these features, you can enjoy the convenience and delightful visual experience that the monitor brings to you!

1.2 Package contents

Check your package for the following items:

- ✓ LCD monitor
- ✓ Monitor base
- ✓ Driver and Manual disc
- ✓ Quick start guide
- ✓ Warranty card
- ✓ Power adapter
- ✓ Power cord
- ✓ DP cable
- ✓ HDMI cable
- ✓ LED projection cover and changeable films
- ✓ Input/Output port cover



If any of the above items is damaged or missing, contact your retailer immediately.









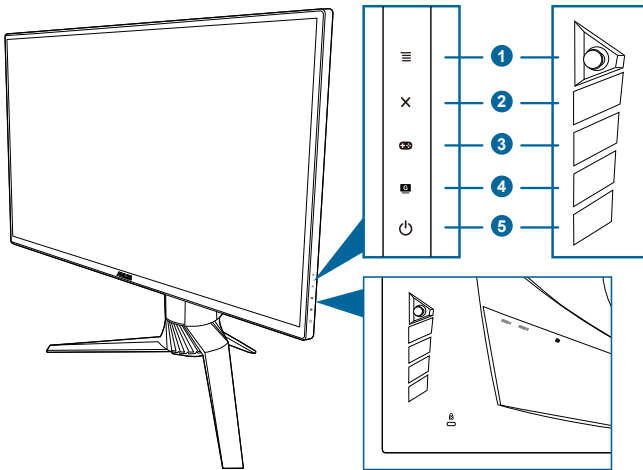

Select "ON" when you see the message "AURA & LIGHT IN MOTION" appears if you want to turn on the light on the base and the back. If you disable this function but later wish to reactivate it, please use the OSD menu to turn it on.

1.3 Monitor introduction

1.3.1 Front/side view



1.  ( 5-way) button:
 - Turns on the OSD menu. Enacts the selected OSD menu item.
 - Increases/Decreases values or moves your selection up/down/left/right.
 - Turns on the OSD menu when the monitor enters standby mode or displays the “NO SIGNAL” message.
2.  button
 - Exits the OSD menu item.
 - Turns on the OSD menu when the monitor enters standby mode or displays the “NO SIGNAL” message.
3.  button:
 - GamePlus hotkey. Move the  button up/down to select and press  to confirm the function needed.
 - Turns on the OSD menu when the monitor enters standby mode or displays the “NO SIGNAL” message.
4.  button
 - GameVisual hotkey. This function contains 8 sub-functions you can select for your preference.
 - Turns on the OSD menu when the monitor enters standby mode or displays the “NO SIGNAL” message.
5.  Power button/power indicator

- Turns the monitor on/off.
- The color definition of the power indicator is as the below table.

Status	Description
White	ON
Amber	Standby mode/No signal
OFF	OFF

1.3.2 Back view

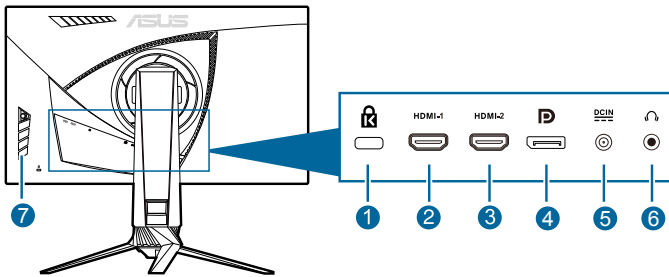







1. **Kensington lock slot.**
2. **HDMI-1 port.** This port is for connection with an HDMI 1.4 compatible device.
3. **HDMI-2 port.** This port is for connection with an HDMI 2.0 compatible device.
4. **DisplayPort.** This port is for connection with a DisplayPort compatible device.
5. **DC-IN port.** This port connects the power cord.
6. **Earphone jack.** This port is only available when an HDMI/DisplayPort cable is connected.
7. **Control buttons.**

1.3.3 GamePlus Function

The GamePlus function provides a toolkit and creates a better gaming environment for users when playing different types of games. The crosshair overlay with four different crosshair options lets you choose the one that best suits the game you're playing. There's also an onscreen timer you can position on the left of the display so you can keep track of the elapsed gaming time; while the FPS (frames per second) counter lets you know how smooth the game is running. Display Alignment displays alignment lines on 4 sides of the screen, serving as an easy and handy tool for you to line up multiple monitors perfectly.

To activate GamePlus:

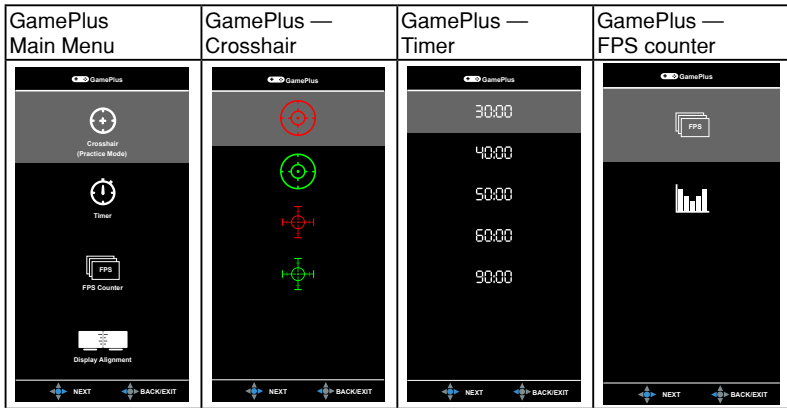

1. Press the GamePlus hotkey.
2. Move the  button up/down to select among different functions.
3. Press the  button or move the  button right to confirm the function you choose, and move the  button up/down to navigate through the settings. Move the  button left to go back, off, and exit.
4. Highlight the desired setting and press the  button to activate it. Press the **X** button to inactivate it.



1.3.4 GameVisual Function

The GameVisual function helps you select among different picture modes in a convenient way.

To activate GameVisual:

1. Press the GameVisual hotkey
2. Move the  button up/down to highlight a desired setting.
3. Press the  button or move the button right to activate it.
4. To exit the menu, move the  button left .
 - **Scenery Mode:** This is the best choice for scenery photo displaying with GameVisual™ Video intelligence Technology.
 - **Racing Mode:** This is the best choice for racing game playing with GameVisual™ Video intelligence Technology.
 - **Cinema Mode:** This is the best choice for movie watching with GameVisual™ Video intelligence Technology.
 - **RTS/RPG Mode:** This is the best choice for Real-Time Strategy (RTS)/ Role-Playing Game (RPG) playing with GameVisual™ Video intelligence Technology.
 - **FPS Mode:** This is the best choice for First Person Shooter game playing with GameVisual™ Video intelligence Technology.
 - **sRGB Mode:** This is the best choice for viewing photos and graphics from PCs.
 - **MOBA Mode:** This is the best choice for multiplayer online battle arena game playing with GameVisual™ Video intelligence Technology.
 - **User Mode:** More items are adjustable in the Color menu.



-
- In the Racing/MOBA mode, the following function(s) are not user-configurable: ASCR, Saturation.
 - In the sRGB mode, the following function(s) are not user-configurable: Color Temp., Brightness, Contrast, ASCR, Saturation.
-

2.1 Assembling the monitor arm/base

1. Insert the base into the arm.
2. Fix the base to the arm by fastening the bundled screw.
3. Attach the LED projection cover to the stand.

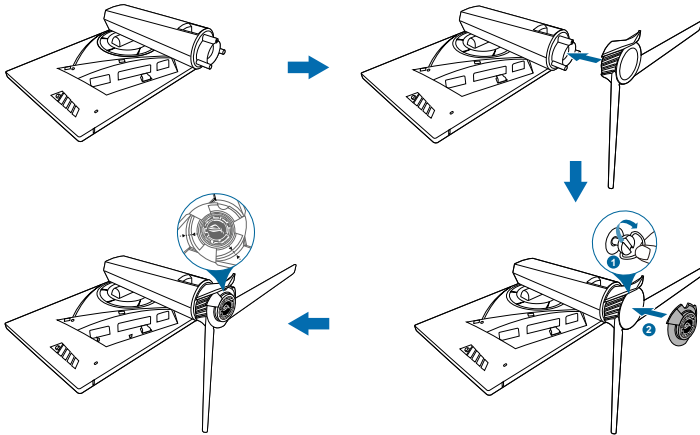

We recommend that you cover the table surface with soft cloth to prevent damage to the monitor.

To change the film on the LED projection cover, follow the illustration below.

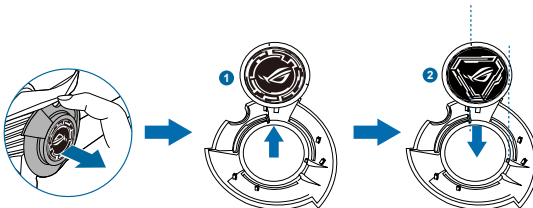

2.2 Cable management

You can organize the cables with the help of the input/output port cover.

- **Arranging the cables**

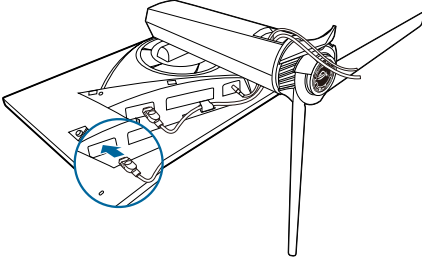

- **Using the input/output port cover:** the cover can be attached or detached.

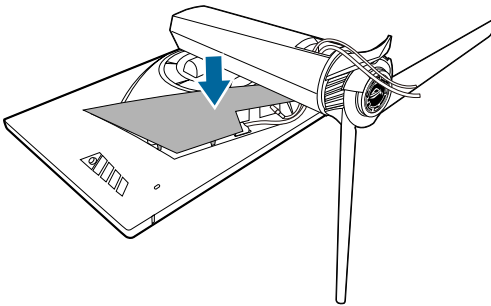

2.3 Adjusting the monitor

- For optimal viewing, we recommend that you look at the full face of the monitor, then adjust the monitor to the angle that is most comfortable for you.
- Hold the stand to prevent the monitor from falling when you change its angle.
- The recommended adjusting angle is $+20^{\circ}$ to -5° (for tilt)/ $+50^{\circ}$ to -50° (for swiveling)/ ± 120 mm (for height adjustment)/ 90° (for portrait view).

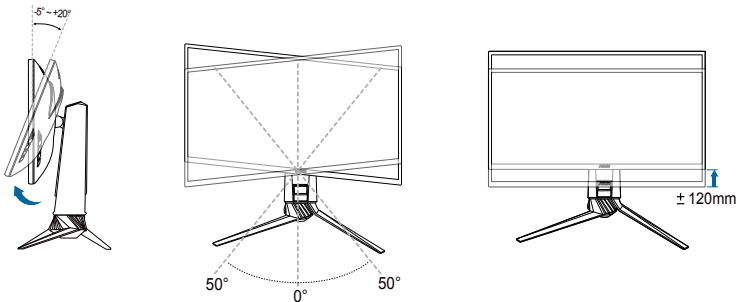

It is normal that the monitor slightly shakes while you adjust the viewing angle.

Pivoting the monitor

1. Lift the monitor to the highest position.
2. Tilt the monitor to its maximum angle.
3. Pivot the monitor clockwise to the angle you need.

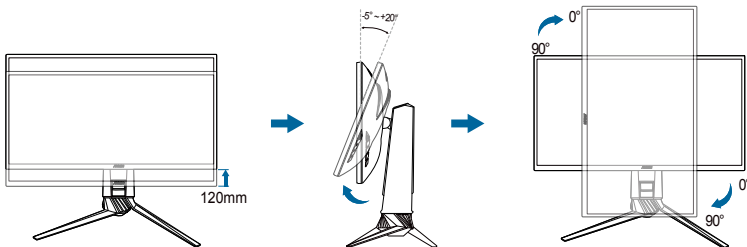

It is normal that the monitor slightly shakes while you adjust the viewing angle.

2.4 Detaching the arm (for VESA wall mount)

The detachable arm of this monitor is specially designed for VESA wall mount.

To detach the arm:

1. Have the front of the monitor face down on a table.
2. Remove the covers on where the monitor and the arm meet.
3. Loosen the four screws on the back of the monitor and remove the arm/base.

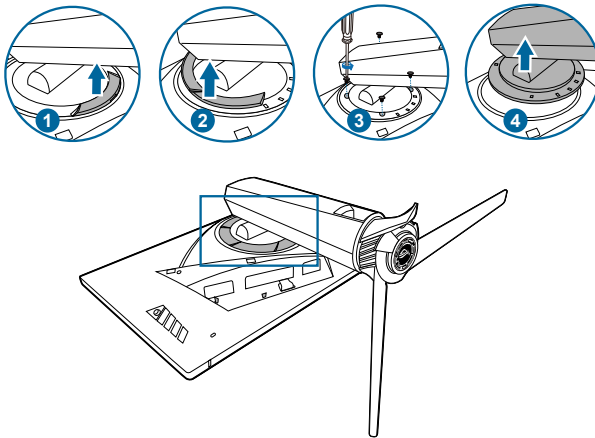

We recommend that you cover the table surface with soft cloth to prevent damage to the monitor.



- The VESA wall mount kit (100 x 100 mm) is purchased separately.
 - Use only the UL Listed Wall Mount Bracket with minimum weight/load 22.7kg (Screw size: M4 x 10 mm)
-

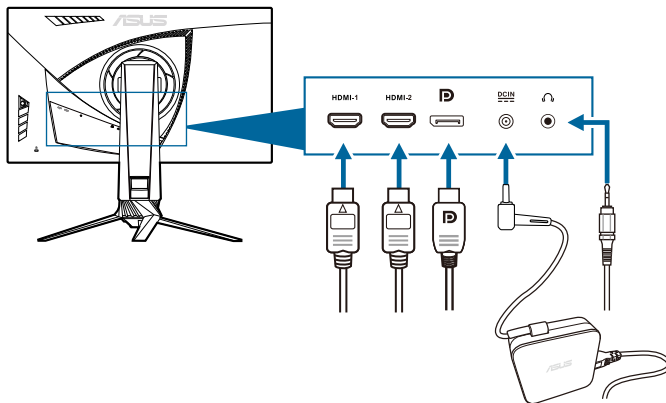

2.5 Connecting the cables

Connect the cables as the following instructions:



- **To connect the power cord:**
 - a. Connect the power adapter securely to the monitor's DC input.
 - b. Connect one end of the power cord to the power adapter and the other end to a power outlet.
- **To connect the DisplayPort/HDMI cable:**
 - a. Plug one end of the DisplayPort/HDMI cable to the monitor's DisplayPort/HDMI port.
 - b. Connect the other end of the DisplayPort/HDMI cable to your computer's DisplayPort/HDMI port.
- **To use the earphone:** connect the end with plug type to the monitor's earphone jack when an HDMI or DisplayPort signal is fed.

2.6 Turning on the monitor









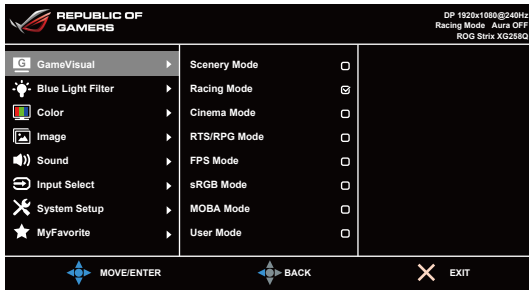







Press the power button . See page 1-2 for the location of the power button. The power indicator  lights up in white to show that the monitor is ON.



3.1 OSD (On-Screen Display) menu

3.1.1 How to reconfigure



1. Press the  () button to activate the OSD menu.
2. Move the  () button up/down to navigate through the functions. Highlight the desired function and press the  () button to activate it. If the function selected has a sub-menu, move the  () button up/down again to navigate through the sub-menu functions. Highlight the desired sub-menu function and press the  () button or move the  () button right to activate it.
3. Move the  () button up/down to change the settings of the selected function.
4. To exit and save the OSD menu, press the  button or move the  () left repeatedly until the OSD menu disappears. To adjust other functions, repeat steps 1-3.

3.1.2 OSD function introduction

1. GameVisual

See 1.3.4 GameVisual Function for details.

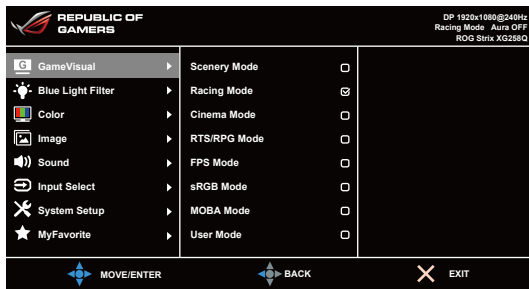

2. Blue Light Filter

In this function, you can adjust the blue light filter level.

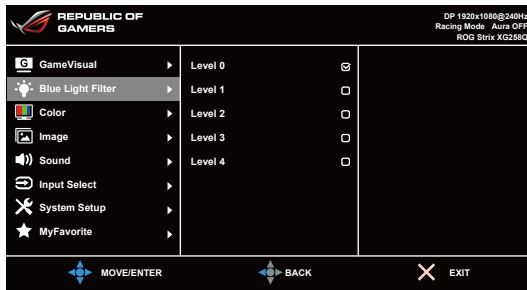

- **Level 0:** No change.
- **Level 1~4:** The higher the level, the less blue light is scattered. When Blue Light Filter is activated, the default settings of Racing Mode will be automatically imported. Between Level 1 to Level 3, the Brightness function is user-configurable. Level 4 is an optimized setting. It is in compliance with TUV Low Blue Light Certification. The Brightness function is not user-configurable.



Please refer to the following to alleviate eye strains:

- Users should take some time away from the display if working for long hours. It is advised to take short breaks (at least 5 mins) after around 1 hour of continuous working at the computer. Taking short and frequent breaks is more effective than a single longer break.
- To minimize eye strain and dryness in your eyes, you should rest the eye periodically by focusing on objects that are far away.
- Eye exercises can help to reduce eye strain. Repeat these exercises often. If eye strain continues please consult a physician. Eye exercises: (1) Repeating look up and down (2) Slowly roll your eyes (3) Move your eyes diagonal.
- High energy blue light may lead to eye strain and AMD (Age-Related Macular Degeneration). Blue light Filter reduces 70% (max.) harmful blue light to avoid CVS (Computer Vision Syndrome).

3. Color

You can adjust Brightness, Contrast, Saturation, Color Temperature, and Gamma from this menu.

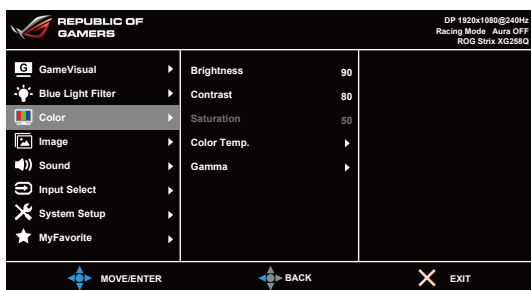

- **Brightness:** The adjusting range is from 0 to 100.
- **Contrast:** The adjusting range is from 0 to 100.
- **Saturation:** The adjusting range is from 0 to 100.
- **Color Temp.:** Contains 4 modes including Cool, Normal, Warm, and User Mode.
- **Gamma:** Allows you to set the color mode to 2.5, 2.2, or 1.8.

4. Image

You can adjust OD, Aspect Control, ASCR, ELMB, and Adaptive-Sync/FreeSync from this menu.

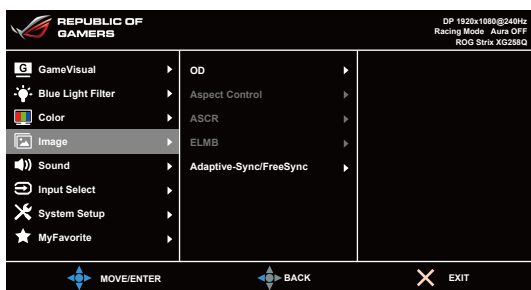

- **OD:** Improves the gray level response time of the LCD panel.
- **Aspect Control:** Adjusts the aspect ratio to Full or 4:3.
- **ASCR:** Turns on/off the ASCR (ASUS Smart Contrast Ratio) function.
- **ELMB:** Turns on/off the ELMB (Extreme Low Motion Blur) function. This function is available when the refresh rate is 100Hz, 120Hz, or 144Hz.
- **Adaptive-Sync/FreeSync:** Allows an Adaptive-Sync/FreeSync supported* graphics source to dynamically adjust display refresh rate based on typical content frame rates for power efficient, virtually stutter free and low-latency display update.



To activate Adaptive-Sync/FreeSync, turn off ELMB function first.

*Adaptive-Sync/FreeSync can only be activated within 48Hz~120Hz for HDMI1.4, and 48Hz~240Hz for HDMI2.0 and DisplayPort.

*For supported GPUs, minimum PC system and driver requirements, please contact the GPU manufactures.

5. Sound

Set the sound related setting from this menu.

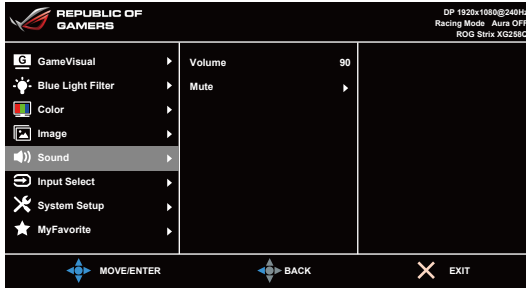

- **Volume:** The adjusting range is from 0 to 100.
- **Mute:** Toggles the monitor sound between on and off.

6. Input Select

In this function, you can select your desired input source.

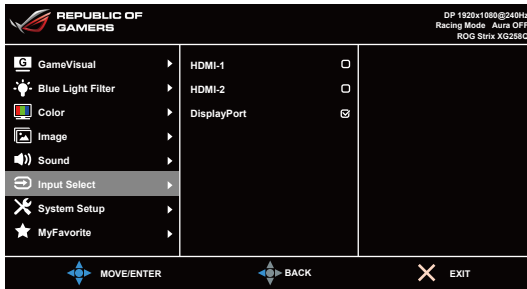

7. System Setup

Allows you to adjust the system.

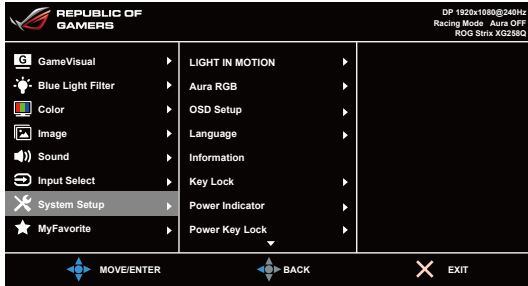

- **LIGHT IN MOTION:** Selects the brightness level of the light on the stand. The adjusting range is from Level 0 to 3, Level 0 = Off.
- **Aura RGB:** There are 6 living colors can be chosen: Rainbow, Color Cycle, Static, Breathing, Strobing, OFF. You can manually change the R/G/B/C/M/Y color for Static, Breathing, and Strobing modes.
- **OSD Setup:**
 - Adjusts the OSD timeout from 10 to 120 seconds.
 - Enables or disables the DDC/CI function.
 - Adjusts the OSD background from opaque to transparent.
- **Language:** There are 21 languages for your selection, including English, French, German, Italian, Spanish, Dutch, Portuguese, Russian, Czech, Croatian, Polish, Romanian, Hungarian, Turkish, Simplified Chinese, Traditional Chinese, Japanese, Korean, Thai, Indonesia, Persian.
- **Information:** Shows the monitor information.
- **Key Lock:** To disable all function keys. Press **X** over 5 seconds to cancel the key lock function.
- **Power Indicator:** Turns the power LED indicator on/off.
- **Power Key Lock:** Enables or disables the power key.
- **All Reset:** Selecting "Yes" allows you to restore the default settings.

8. MyFavorite

Loads/Saves all settings on the monitor.

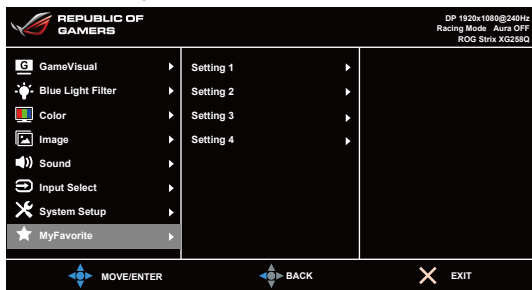

3.2 Specifications summary

Panel type	TFT LCD
Panel size	24.5"W (16:9, 62.2 cm) wide screen
Max. resolution	1920 x 1080
Pixel pitch	0.2832 mm x 0.2802 mm
Brightness (Typ.)	400 cd/m ²
Contrast ratio (Typ.)	1000:1
Viewing angle(H/V) CR>10	170°/160°
Display colors	16.7 M
Response time	1 ms (Gray to Gray)
Color temperature selection	4 color temperatures
Analog input	No
Digital input	DisplayPort v1.2 x 1, HDMI v1.4 x 1/v2.0 x 1
Earphone jack	Yes
Audio input	No
Speaker (Built-in)	No
Colors	Black
Power LED	White (On)/Amber (Standby)
Tilt	+20°~ -5°
Pivot	90° (clockwise)
Swivel	+50° ~ -50°
Height adjustment	120 mm
VESA wall mount	100 x 100 mm
Kensington lock	Yes
Voltage rating	AC: 100~240V DC: 19V, 3.42A (AC adapter)
Power consumption	Power On: < 65 W, Standby: < 0.5 W, Power Off: < 0.5 W
Temperature (Operating)	0°C~40°C
Temperature (Non-operating)	-20°C~+60°C
Dimensions (W x H x D)	564.2 x 383.7 x 253.7 mm (lowest) 564.2 x 503.7 x 253.7 mm (highest) 661 x 443 x 239 mm (package)
Weight (Esti.)	5.5 kg (Net); 8.2 kg (Gross)
Multi-languages	21 languages (English, French, German, Italian, Spanish, Dutch, Portuguese, Russian, Czech, Croatian, Polish, Romanian, Hungarian, Turkish, Simplified Chinese, Traditional Chinese, Japanese, Korean, Thai, Indonesia, Persian)
Accessories	DP cable, HDMI cable, Power adapter, Power cord, Driver and Manual disc, Quick start guide, Warranty card, LED projection cover and changeable films, Input/Output port cover

Compliance and standards

CB, CE, CU, CCC, UL/cUL, FCC, RCM, BSMI, VCCI, RoHS, WEEE, J-MOSS, ErP, PSE, CEL, Windows 7 WHQL, Windows 8.1 WHQL, Windows 10 WHQL, KCC, E-Standby, TUV-Flicker Free, TUV-Low Blue Light, UkrSEPRO, MEPS

***Specifications are subject to change without notice.**

3.3 Troubleshooting (FAQ)

Problem	Possible Solution
Power LED is not ON	<ul style="list-style-type: none">• Press the  button to check if the monitor is in the ON mode.• Check if the power cord is properly connected to the monitor and the power outlet.
The power LED lights white and there is no screen image	<ul style="list-style-type: none">• Check if the monitor and the computer are in the ON mode.• Make sure the signal cable is properly connected the monitor and the computer.• Inspect the signal cable and make sure none of the pins are bent.• Connect the computer with another available monitor to check if the computer is properly working.
Screen image is too light or dark	<ul style="list-style-type: none">• Adjust the Contrast and Brightness settings via OSD.
Screen image bounces or a wave pattern is present in the image	<ul style="list-style-type: none">• Make sure the signal cable is properly connected to the monitor and the computer.• Move electrical devices that may cause electrical interference.
Screen image has color defects (white does not look white)	<ul style="list-style-type: none">• Inspect the signal cable and make sure that none of the pins are bent.• Perform All Reset via OSD.• Adjust the R/G/B color settings or select the Color Temperature via OSD.

3.4 Supported operating mode

Resolution frequency	Refresh rate	Horizontal
640x350	70Hz	31.469KHz
640x350	85Hz	37.861KHz
640x480	60Hz	31.469KHz
640x480	67Hz	35KHz
640x480	75Hz	37.5KHz
640x480	85Hz	43.269KHz
720x400	70Hz	31.469KHz
720x400	85Hz	37.927KHz
800x600	56Hz	35.156KHz
800x600	60Hz	37.897KHz
800x600	72Hz	48.077KHz
800x600	75Hz	46.875KHz
800x600	85Hz	53.674KHz
832x624	75Hz	49.725KHz
848x480	60Hz	31.02KHz
1024x768	60Hz	48.363KHz
1024x768	70Hz	56.476KHz
1024x768	75Hz	60.023KHz
1024x768	85Hz	68.677KHz
1152x864	75Hz	67.5KHz
1280x720	60Hz	44.444KHz
1280x720	60Hz	44.772KHz
1280x720	75Hz	56.456KHz
1280x768	60Hz	47.396KHz
1280x800	60Hz	49.306KHz
1280x800	60Hz	49.702KHz
1280x800	75Hz	62.795KHz
1280x960	60Hz	60KHz
1280x1024	60Hz	63.981KHz
1280x1024	75Hz	79.976KHz
1366x768	60Hz	47.712KHz
1440x900	60Hz	55.469KHz
1440x900	60Hz	55.935KHz
1440x900	75Hz	70.635KHz

1680x1050	60Hz	64.674KHz
1680x1050	60Hz	65.29KHz
1920x1080	60Hz	66.587KHz
1920x1080	60Hz	67.5KHz
1920x1080	85Hz	95.43KHz
1920x1080*	100Hz	113.3KHz
1920x1080*	120Hz	137.2KHz
1920x1080* (DP)	144Hz	158.11KHz
1920x1080 (DP/HDMI-2)	240Hz	291.309KHz
640x480P (HDMI)	59.94/60Hz	31.469KHz/31.5KHz
720x480P (HDMI)	59.94/60Hz	31.469KHz/31.5KHz
720x576P (HDMI)	50Hz	31.25KHz
1280x720P (HDMI)	50Hz	37.5KHz
1280x720P (HDMI)	59.94/60Hz	44.955KHz/45KHz
1440x480P (HDMI)	59.94/60Hz	31.469KHz/31.5KHz
1440x576P (HDMI)	50Hz	31.25KHz
1920x1080P (HDMI)	50Hz	56.25KHz
1920x1080P (HDMI)	59.94/60Hz	67.433KHz/67.5KHz

Note:

***Only DP supports Extreme Low Motion Blur.**



REPUBLIC OF
GAMERS