



> PRINT > COPY > SCAN > FAX

ECOSYS M3040idn  
ECOSYS M3540idn  
ECOSYS M3550idn  
ECOSYS M3560idn

# OPERATION GUIDE



# Preface

Thank you for purchasing the ECOSYS M3040idn/ECOSYS M3540idn/ECOSYS M3550idn/ECOSYS M3560idn.

This Operation Guide is intended to help you operate the machine correctly, perform routine maintenance, and take simple troubleshooting measures as needed so that the machine can always be used in the optimum condition.

Please read this Operation Guide before using the machine.

## We recommend the use of our own brand supplies.

Please use our genuine toner containers, which have passed rigorous quality control testing.

The use of non-genuine toner containers may cause failure.

We will not be liable for any damages caused by the use of third party supplies in this machine.

A label is affixed to our genuine supplies as shown below.

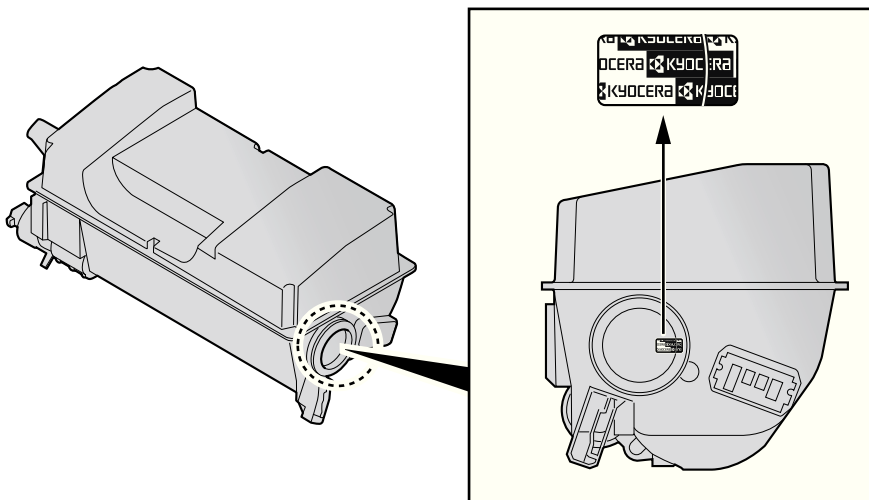

# Contents

<b>Preface</b> .....	<b>i</b>
<b>Overview</b> .....	<b>viii</b>
<b>Machine Features</b> .....	<b>ix</b>
<b>Guides Provided with the Machine</b> .....	<b>xiii</b>
<b>About the Operation Guide (this Guide)</b> .....	<b>xiv</b>
Structure of the guide .....	xiv
Conventions Used in This Guide .....	xv
<b>Menu Map</b> .....	<b>xviii</b>

## **1 Legal and Safety Information ..... 1-1**

<b>Notice</b> .....	<b>1-2</b>
Safety Conventions in This Guide .....	1-2
Environment .....	1-3
Precautions for Use .....	1-4
Laser Safety (Europe) .....	1-5
SAFETY OF LASER BEAM (USA) .....	1-6
Safety Instructions Regarding the Disconnection of Power .....	1-7
WARNING .....	1-7
Radio Tag Technology .....	1-7
Other precautions (for users in California, the United States) .....	1-7
Warranty (the United States and Canada) .....	1-8
Legal Restriction on Copying/Scanning .....	1-10
EN ISO 7779 .....	1-10
EK1-ITB 2000 .....	1-10
Legal Information .....	1-11
Energy Saving Control Function .....	1-17
Automatic 2-Sided Copy Function .....	1-17
Resource Saving - Paper .....	1-17
Environmental benefits of "Power Management" .....	1-17
Energy Star (ENERGY STAR®) Program .....	1-18

## **2 Installing and Setting up the Machine ..... 2-1**

<b>Part Names</b> .....	<b>2-2</b>
Machine Exterior .....	2-2
Connectors/Interior .....	2-3
With Optional Equipments Attached .....	2-4
<b>Connecting the Machine and Other Devices</b> .....	<b>2-5</b>
<b>Connecting Cables</b> .....	<b>2-6</b>
Connecting LAN Cable .....	2-6
Connecting USB Cable .....	2-7
Connecting the Power Cable .....	2-7
<b>Power On/Off</b> .....	<b>2-8</b>
Power On .....	2-8
Power Off .....	2-8
<b>Login/Logout</b> .....	<b>2-9</b>
Login .....	2-9
Logout .....	2-10
<b>Default Settings of the Machine</b> .....	<b>2-11</b>
Setting Date and Time .....	2-11
Network Setup (LAN Cable Connection) .....	2-13
<b>Energy Saver function</b> .....	<b>2-14</b>
Low Power Mode and Auto Low Power Mode .....	2-14
Sleep and Auto Sleep .....	2-15
<b>Quick Setup Wizard</b> .....	<b>2-17</b>
<b>Installing Software</b> .....	<b>2-20</b>
Software on DVD (Windows) .....	2-20

Installing Software in Windows .....	2-21
Uninstalling the Software .....	2-26
Installing Software in Mac Computer .....	2-27
Setting TWAIN Driver .....	2-29
Setting WIA Driver .....	2-30
<b>Checking the Counter .....</b>	<b>2-31</b>
<b>Additional Preparations for the Administrator .....</b>	<b>2-32</b>
Sending Documents to a PC .....	2-32
Strengthening the Security .....	2-32
<b>Command Center RX .....</b>	<b>2-34</b>
Accessing Command Center RX .....	2-35
Changing Security Settings .....	2-37
Changing Device Information .....	2-39
E-mail Settings .....	2-41
Registering Destinations .....	2-45
Creating a New Custom Box .....	2-47
Printing a document stored in a Custom Box .....	2-48
<b>Transferring Data from Our Other Products .....</b>	<b>2-50</b>
Migrating the Address Book .....	2-50

### **3 Preparation before Use ..... 3-1**

<b>Using the Operation Panel .....</b>	<b>3-2</b>
Operation Panel Keys .....	3-2
Adjusting the Operation Panel Angle .....	3-3
<b>Touch Panel Display .....</b>	<b>3-4</b>
Home Screen .....	3-4
Display for Device Information .....	3-8
Display of Keys That Cannot Be Set .....	3-9
Enter key and Quick No. Search key .....	3-10
Help Screen .....	3-11
<b>Loading Paper .....</b>	<b>3-12</b>
Precaution for Loading Paper .....	3-13
Loading in the Cassettes .....	3-14
Loading Paper in the Multi Purpose Tray .....	3-18
Specifying Paper Size and Media Type .....	3-22
<b>Paper Stopper .....</b>	<b>3-24</b>
<b>Preparation for Sending a Document to a Shared Folder in a PC .....</b>	<b>3-25</b>
Making a note of the computer name and full computer name .....	3-25
Making a note of the user name and domain name .....	3-26
Creating a Shared Folder, Making a Note of a Shared Folder .....	3-27
Configuring Windows Firewall .....	3-31
<b>Registering Destinations in the Address Book .....</b>	<b>3-35</b>
Adding a Destination (Address Book) .....	3-35
Adding a Destination on One Touch Key (One Touch Key) .....	3-41

### **4 Printing from PC ..... 4-1**

<b>Printing from PC .....</b>	<b>4-2</b>
Printing on Non-standard Sized Paper .....	4-4
Printer Driver Print Settings Screen .....	4-5
Printer Driver Help .....	4-6
Changing the Default Printer Driver Settings (Windows 7) .....	4-6
Canceling Printing from a Computer .....	4-6
<b>Printing by AirPrint .....</b>	<b>4-7</b>
<b>Printing Data Saved on the Printer .....</b>	<b>4-8</b>
Specifying the Job Box from a Computer and Storing the Job .....	4-8
Printing Documents from Private Print Box .....	4-8
Printing Document from Stored Job Box .....	4-11
Printing Document from Quick Copy Box .....	4-14



<b>5</b>	<b>Operation on the Machine</b> .....	<b>5-1</b>
	<b>Loading Originals</b> .....	<b>5-2</b>
	Placing Originals on the Platen .....	5-2
	Loading Originals in the Document Processor .....	5-3
	<b>Favorites</b> .....	<b>5-5</b>
	Registering Favorite .....	5-6
	Recalling Favorite .....	5-9
	Editing and Deleting Favorite .....	5-10
	<b>Application</b> .....	<b>5-11</b>
	Installing Applications .....	5-11
	Using Applications .....	5-12
	Uninstalling Applications .....	5-13
	<b>Registering Shortcuts</b> .....	<b>5-14</b>
	Adding Shortcuts .....	5-14
	Editing and Deleting Shortcuts .....	5-15
	<b>Copying</b> .....	<b>5-16</b>
	Basic Operation .....	5-16
	Reserve Next .....	5-17
	Canceling Jobs .....	5-18
	<b>Sending</b> .....	<b>5-19</b>
	Basic Operation .....	5-20
	Specifying Destination .....	5-22
	Checking and Editing Destinations .....	5-30
	Confirmation Screen of Destinations .....	5-31
	Recall .....	5-32
	Send to Me (E-mail) .....	5-32
	Sending to Different Types of Destinations (Multi Sending) .....	5-33
	Canceling Sending Jobs .....	5-34
	WSD Scan .....	5-35
	Scanning using TWAIN .....	5-37
	Scanning with FMU Connection .....	5-39
	<b>How to use the FAX Function</b> .....	<b>5-40</b>
	<b>What is Document Box?</b> .....	<b>5-41</b>
	Basic Operation for Document Box .....	5-42
	<b>Using a Custom Box</b> .....	<b>5-43</b>
	Creating a New Custom Box .....	5-43
	Editing and Deleting Custom Box .....	5-45
	Storing Documents .....	5-46
	Printing Documents .....	5-47
	Editing Documents .....	5-48
	Deleting Documents .....	5-49
	<b>Printing Documents Stored in Removable USB Memory</b> .....	<b>5-50</b>
	<b>Saving Documents to USB Memory (Scan to USB)</b> .....	<b>5-52</b>
	<b>Check the USB Memory Information</b> .....	<b>5-53</b>
	<b>Removing USB Memory</b> .....	<b>5-54</b>
<b>6</b>	<b>Using Various Functions</b> .....	<b>6-1</b>
	<b>Functions Available on the Machine</b> .....	<b>6-2</b>
	Copy .....	6-2
	Send .....	6-3
	Custom Box (Printing) .....	6-5
	Removable Memory (Store File, Printing Documents) .....	6-6
	<b>Functions</b> .....	<b>6-8</b>
	Original Size .....	6-8
	Paper Selection .....	6-9
	Original Orientation .....	6-10

Collate .....	6-10
Density .....	6-11
Original Image .....	6-11
EcoPrint .....	6-12
Color Selection .....	6-12
Sharpness .....	6-13
Background Density Adj. (Background Density Adjustment) .....	6-13
Prevent Bleed-thru .....	6-14
Zoom .....	6-14
Combine .....	6-16
Duplex .....	6-18
Continuous Scan .....	6-19
Job Finish Notice .....	6-20
File Name Entry .....	6-21
Priority Override .....	6-21
Quiet Mode .....	6-21
Duplex (2-sided Original) .....	6-22
Sending Size .....	6-23
File Format .....	6-24
File Separation .....	6-27
Scan Resolution .....	6-27
E-mail Subject/Body .....	6-27
FTP Encrypted TX .....	6-28
Delete after Printed .....	6-28
Storing Size .....	6-29
Encrypted PDF Password .....	6-29
JPEG/TIFF Print .....	6-30
XPS Fit to Page .....	6-30

## **7 Status/Job Cancel ..... 7-1**

<b>Checking Job Status .....</b>	<b>7-2</b>
Details of the Status Screens .....	7-4
Checking Detailed Information of Jobs .....	7-8
<b>Checking Job History .....</b>	<b>7-9</b>
Checking the Detailed Information of Histories .....	7-11
Sending the Log History .....	7-11
<b>Job Operation .....</b>	<b>7-12</b>
Pause and Resumption of Jobs .....	7-12
Canceling of Jobs .....	7-12
<b>Device/Communication .....</b>	<b>7-13</b>
<b>Checking the Remaining Amount of Toner and Paper (Paper/Supplies) .....</b>	<b>7-15</b>

## **8 Setup and Registration (System Menu) ..... 8-1**

<b>System Menu .....</b>	<b>8-2</b>
Operation Method .....	8-2
System Menu Settings .....	8-4
Language .....	8-6
Report .....	8-6
User Property .....	8-9
Cassette/MP Tray Settings .....	8-9
Common Settings .....	8-11
Home .....	8-19
Copy .....	8-20
Send .....	8-21
Document Box .....	8-22
FAX .....	8-22
Application .....	8-23
Internet .....	8-23

Address Book/One Touch .....	8-23
User Login/Job Accounting .....	8-24
Printer .....	8-25
System/Network .....	8-27
Date/Timer/Energy Saver .....	8-37
Adjustment/Maintenance .....	8-40

## **9 User Authentication and Accounting (User Login, Job Accounting) 9-1**

<b>Overview of User Login Administration .....</b>	<b>9-2</b>
<b>Enabling User Login Administration .....</b>	<b>9-3</b>
<b>Setting User Login Administration .....</b>	<b>9-5</b>
Adding a User (Local User List) .....	9-5
Changing User Properties .....	9-9
User Account Lockout Setting .....	9-13
User Login Administration for Printing .....	9-15
To Manage the Users to Scan Using TWAIN .....	9-16
To Manage the Users to Scan Using WIA .....	9-17
To Manage the Users that Send Faxes from a PC .....	9-18
Local Authorization .....	9-19
Group Authorization Settings .....	9-20
Obtain NW User Property .....	9-23
Simple Login Settings .....	9-25
ID Card Settings .....	9-29
<b>Using User Login Administration .....</b>	<b>9-31</b>
Login/Logout .....	9-31
User Login Administration on a PC .....	9-31
<b>Overview of Job Accounting .....</b>	<b>9-32</b>
<b>Enabling Job Accounting .....</b>	<b>9-33</b>
Job Accounting Access .....	9-34
<b>Setting an Account .....</b>	<b>9-35</b>
Adding an Account .....	9-35
Restricting the Use of the Machine .....	9-37
Editing an Account .....	9-38
Deleting an Account .....	9-40
Job Accounting for Printing .....	9-41
Job Accounting for Scan Using TWAIN .....	9-42
Job Accounting for Scan Using WIA .....	9-43
Job Accounting for the FAX Transmitted from a Computer .....	9-44
<b>Configuring Job Accounting .....</b>	<b>9-45</b>
Default Setting .....	9-45
Counting the Number of Pages Printed .....	9-46
Print Accounting Report .....	9-47
<b>Using Job Accounting .....</b>	<b>9-49</b>
Login/Logout .....	9-49
Job Accounting on a PC .....	9-49
<b>Unknown ID Job .....</b>	<b>9-50</b>

## **10 Troubleshooting ..... 10-1**

<b>Regular Maintenance .....</b>	<b>10-2</b>
Cleaning .....	10-2
Toner Container Replacement .....	10-5
Waste Toner Box Replacement .....	10-8
<b>Troubleshooting .....</b>	<b>10-10</b>
Solving Malfunctions .....	10-10
Responding to Messages .....	10-15
Adjustment/Maintenance .....	10-25
Clearing Paper Jams .....	10-26

---

<b>11</b>	<b>Appendix .....</b>	<b>11-1</b>
	<b>Optional Equipment .....</b>	<b>11-2</b>
	Overview of Optional Equipment .....	11-2
	Optional Applications .....	11-10
	<b>Character Entry Method .....</b>	<b>11-12</b>
	Entry Screens .....	11-12
	Entering Characters .....	11-14
	<b>Paper .....</b>	<b>11-15</b>
	Basic Paper Specifications .....	11-15
	Choosing the Appropriate Paper .....	11-16
	Special Paper .....	11-19
	<b>Specifications .....</b>	<b>11-23</b>
	Common Functions .....	11-23
	Copy Functions .....	11-25
	Printer Functions .....	11-25
	Scanner Functions .....	11-26
	Document Processor .....	11-26
	Paper Feeder (500-sheet) (Option) .....	11-27
	<b>Glossary .....</b>	<b>11-28</b>
	<b>Index .....</b>	<b>Index-1</b>

# Overview

This machine is equipped standard with copy and print functions, and a scanned image can be sent to an E-mail recipient as an attachment or to a computer on the same network. On products with a FAX function, it is also possible to use the fax function.

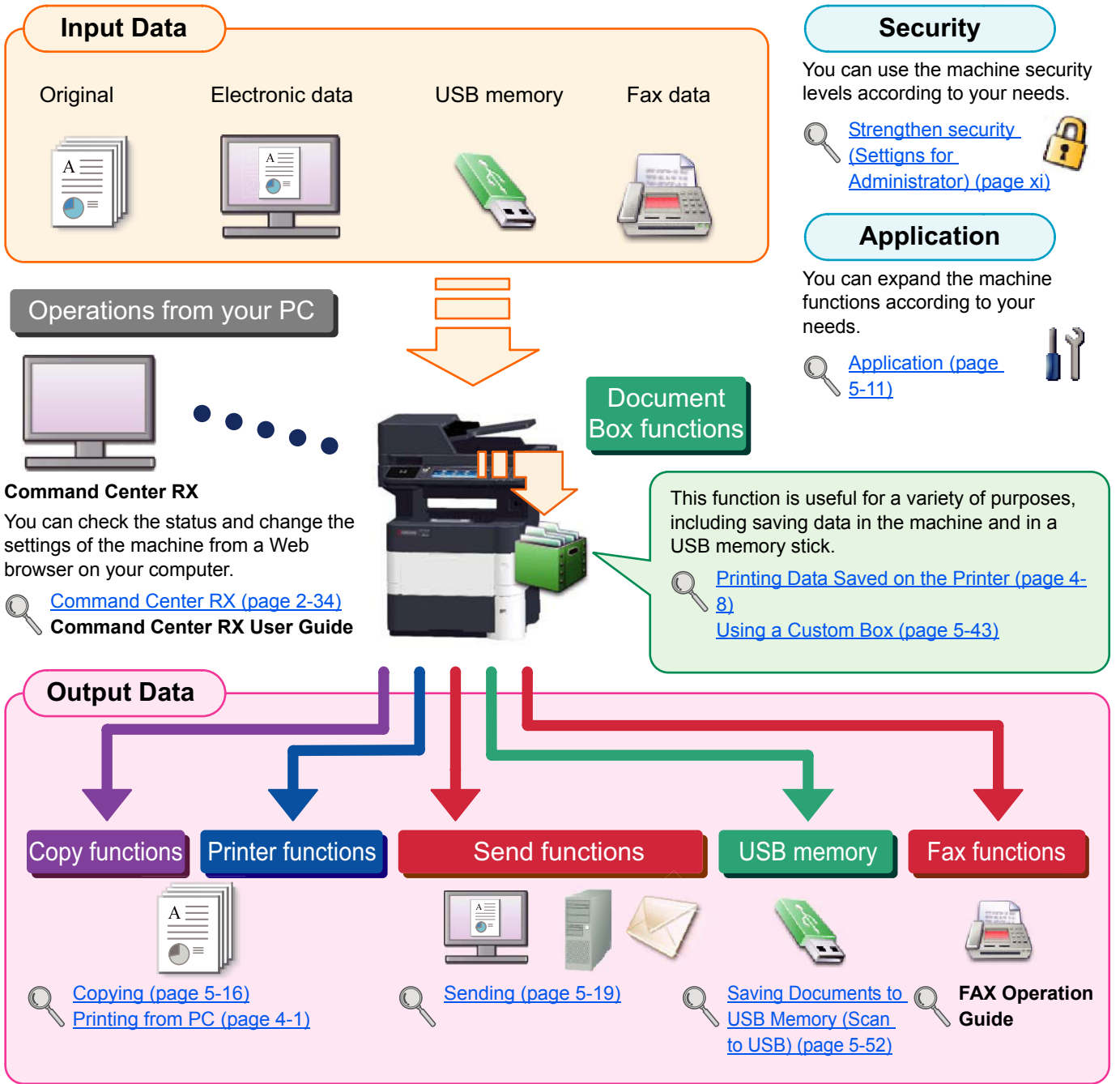









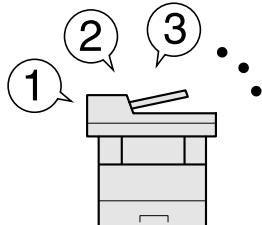

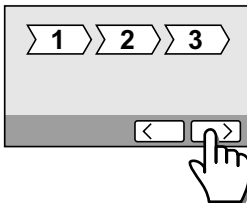

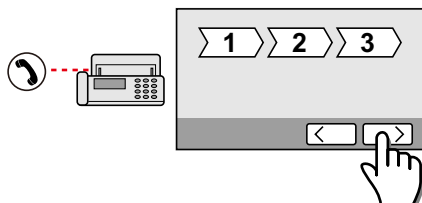
**NOTE**



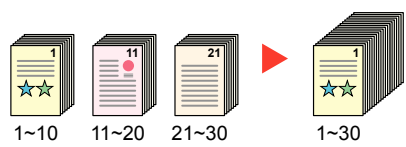

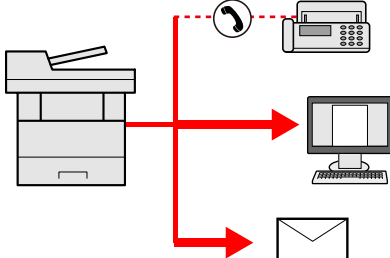

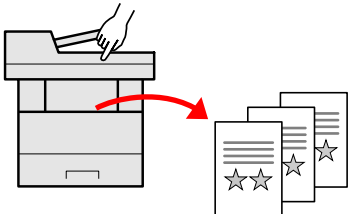
- Before using the machine, be sure to read [Legal and Safety Information on page 1-1](#).
- For preparations for use of the machine such as cable connections and software installation, refer to [Installing and Setting up the Machine on page 2-1](#).
- To learn how to load paper, set up shared folders, and add addresses to the address book, refer to [Preparation before Use on page 3-1](#).



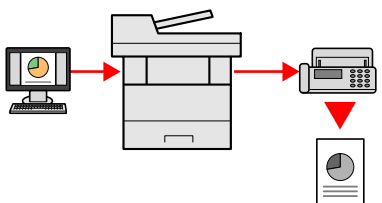

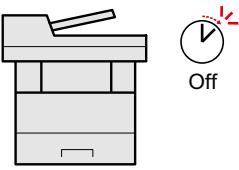

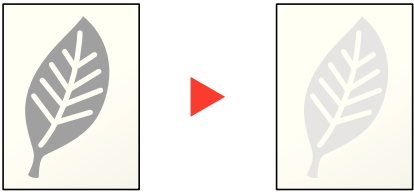
# Machine Features



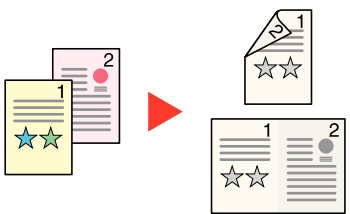

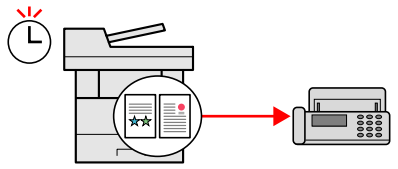

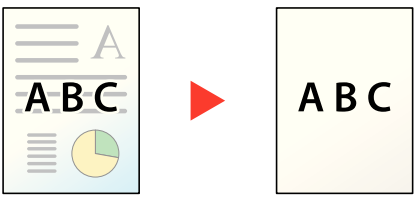
The machine is equipped with many useful functions. Here are some examples. For details, refer to [Using Various Functions \(page 6-1\)](#).



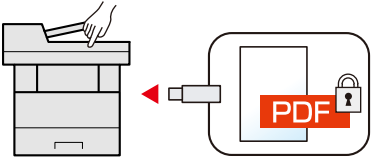

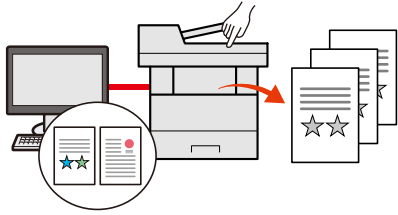

Optimize your office workflow		
<p><b>Access to frequently used functions with just one touch (Favorites)</b></p>  <p>You can preset frequently used functions. Once you register frequently used settings as favorite, you can call up the settings easily. Using this favorite brings the same results even if operated by another person.</p> <p> <a href="#">Favorites (page 5-5)</a></p>	<p><b>Set up the machine easily (Quick Setup Wizard)</b></p>  <p>You can configure the necessary settings before using the machine in the wizard mode.</p> <p> <a href="#">Quick Setup Wizard (page 2-17)</a></p>	<p><b>Set up fax easily (FAX Setup)</b></p>  <p>You can configure the necessary settings before using fax in the wizard mode.</p> <p> <a href="#">FAX Setup (page 2-17)</a></p>

Optimize your office workflow		
<p><b>Scan a large number of originals in separate batches and produce as one job (Continuous Scan)</b></p>  <p>It is useful when preparing many-page handouts.</p> <p>When a large number of originals cannot be placed in the document processor at one time, the originals can be scanned in separate batches and then copied or sent as one job.</p> <p> <a href="#">Continuous Scan (page 6-19)</a></p>	<p><b>Send one time with multiple sending options (Multi Sending)</b></p>  <p>You can send a same document to the multiple destinations using a different method.</p> <p>You can specify multiple destinations of different send methods such as E-mail, SMB, and Fax.</p> <p>You can reduce your workflow by sending a job at once.</p> <p> <a href="#">Sending to Different Types of Destinations (Multi Sending) (page 5-33)</a></p>	<p><b>Save frequently used documents in the machine (Custom Box)</b></p>  <p>You can save the frequently used document in the machine and print it when needed.</p> <p> <a href="#">Using a Custom Box (page 5-43)</a></p>

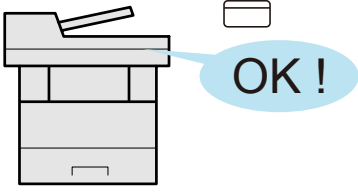
Optimize your office workflow	Save energy and cost	
<p><b>Send a FAX from a PC (Sending FAX from PC)</b></p>  <p>You can save the paper used for sending a FAX with this function.</p> <p>You can send a file to be faxed from the PC without printing the file, so that you can reduce the number of pieces of paper and perform sending jobs efficiently.</p> <p> <b>FAX Operation Guide</b></p>	<p><b>Save energy as needed (Energy Saver function)</b></p>  <p>The machine is equipped with Energy Saver function that automatically switched into Low Power Mode or Sleep Mode.</p> <p> <a href="#">Energy Saver function (page 2-14)</a></p>	<p><b>Use less toner for printing (EcoPrint)</b></p>  <p>You can save toner consumption with this function.</p> <p>When you only need to check the printed content, such as a trial print run or documents for internal confirmation, use this function to save toner.</p> <p>Use this function when a high-quality print is not required.</p> <p> <a href="#">EcoPrint (page 6-12)</a></p>

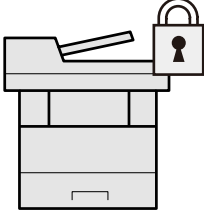

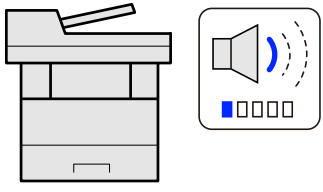



Save energy and cost		Create attractive documents
<p><b>Reduce paper use (Paper Saving Copy)</b></p>  <p>You can print originals on both sides of the paper. You can also print multiple originals onto one sheet.</p> <p> <a href="#">Combine (page 6-16)</a> <a href="#">Duplex (page 6-18)</a></p>	<p><b>Send a FAX to reduce the communication cost (FAX Delayed Transmission)</b></p>  <p>You can reduce the communication cost with this function.</p> <p>The communication cost can be reduced by setting the timer to the time period during which the communication cost is low.</p> <p> <b>FAX Operation Guide</b></p>	<p><b>Prevent image bleed-through (Prevent Bleed-through)</b></p>  <p>You can prevent image bleed-through from the reverse side when scanning thin originals.</p> <p> <a href="#">Prevent Bleed-thru (page 6-14)</a></p>

Strengthen security		
<p><b>Password-protect a PDF file</b> (PDF Encryption Functions)</p>  <p>Use the PDF format's password security options to restrict document viewing, printing and editing.</p> <p> <a href="#">Encrypted PDF Password (page 6-29)</a></p>	<p><b>Protect data on the SSD</b> (Encryption / Overwrite)</p>  <p>You can overwrite the unnecessary data that remains on the SSD automatically. To prevent an external leakage, the machine is able to encrypt data before writing it to the SSD.</p> <p> <a href="#">Data Security (page 8-36)</a></p>	<p><b>Prevent loss of finished documents</b> (Private Print)</p>  <p>You can temporarily save a printer document in the machine. By printing the document from the machine prevents someone takes your document.</p> <p> <a href="#">Printing Data Saved on the Printer (page 4-8)</a></p>

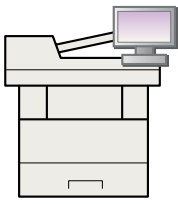

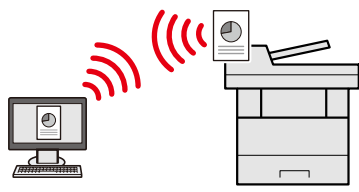

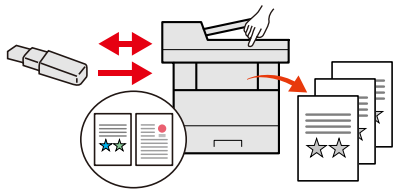
Strengthen security	Use functions more efficiently	
<p><b>Log in by ID card</b> (Card Authentication)</p>  <p>You can log in simply by touching an ID card. You don't need to enter your user name and password.</p> <p> <a href="#">Card Authentication Kit(B) "Card Authentication Kit" (page 11-3)</a></p>	<p><b>Strengthen security</b> (Settings for Administrator)</p>  <p>Various functions are available for administrators to strengthen security.</p> <p> <a href="#">Strengthening the Security (page 2-32)</a></p>	<p><b>Make the machine quiet</b> (Quiet Mode)</p>  <p>You can make the machine quiet by reducing its running noise. You can configure this mode by job.</p> <p> <a href="#">Quiet Mode (page 6-21)</a></p>

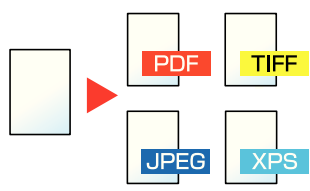

**Use functions more efficiently**

<p><b>Expand functions as necessary (Application)</b></p>  <p>The functionality of the machine can be expanded by installing applications. Applications that help you perform your daily more efficiently such as a scan feature and an authentication feature are available.</p> <p> <a href="#">Application (page 5-11)</a></p>	<p><b>Install the machine without concerning the network cables (Wireless Network)</b></p>  <p>In an environment where the wireless LAN is used, you can install the machine without concerning the network cables.</p> <p> <a href="#">Wireless Network (page 8-33)</a></p>	<p><b>Use USB memory (USB Memory)</b></p>  <p>It is useful when you need to print document outside your office or you cannot print document from your PC. You can print the document from the USB memory by plugging it directly into the machine.</p> <p>Original scanned at the machine can be saved in the USB memory also.</p> <p> <a href="#">Printing Documents Stored in Removable USB Memory (page 5-50)</a> <a href="#">Saving Documents to USB Memory (Scan to USB) (page 5-52)</a></p>
---	--	---

**Use functions more efficiently**

<p><b>Specify image file format (File Format)</b></p>  <p>You can select the various file formats when sending/storing images.</p> <p> <a href="#">File Format (page 6-24)</a></p>	<p><b>Perform remote operation (Command Center RX)</b></p>  <p>You can access to the machine remotely to print, send or download data. Administrators can configure the machine behavior or management settings.</p> <p> <a href="#">Command Center RX (page 2-34)</a></p>
--	---

# Guides Provided with the Machine

The following guides are provided with the machine. Refer to each guide as needed. The contents of the guides are subject to change without notice for the purpose of improvement of machine performance.

## Printed guides

**Start using the machine quickly**

### Quick Guide

Explains how to use basic functions of the machine, how to use convenient features, how to perform routine maintenance, and what to do when problems occur.

**For safe use of the machine**

### Safety Guide

Provides safety and cautionary information for installation environment and use of the machine. Be sure to read this guide before using the machine.

### Safety Guide (ECOSYS M3040idn/ECOSYS M3540idn/ECOSYS M3550idn/ECOSYS M3560idn)

Indicates the space required for machine installation, and describes the cautionary labels and other safety information. Be sure to read this guide before using the machine.

## Guides (PDF) on the DVD (Product Library)

**Use the machine thoughtfully**

### Operation Guide (This Guide)

Explains how to load paper and perform copy, print and scan operations, and indicates default settings and other information.

**Use the fax functions**

### FAX Operation Guide

Explains how to use the fax function.

**Use the ID card**

### Card Authentication Kit (B) Operation Guide

Explains how to perform authentication using the ID card.

**Strengthen security**

### Data Security Kit (E) Operation Guide

Explains how to introduce and use the Data Security kit (E), and how to overwrite and encrypt data.

**Easily register machine information and configure settings**

### Command Center RX User Guide

Explains how to access the machine from a Web browser on your computer to check and change settings.

**Print data from a computer**

### Printer Driver User Guide

Explains how to install the printer driver and use the printer function.

**Directly print a PDF file**

### KYOCERA Net Direct Print Operation Guide

Explains how to print PDF files without launching Adobe Acrobat or Reader.

**Monitor the machine and printers on the network**

### KYOCERA Net Viewer User Guide

Explains how to monitor your network printing system (the machine) with KYOCERA Net Viewer.

**Scan images and save with information**

### File Management Utility User Guide

Explains how to use File Management Utility to set various parameters and send and save scanned documents.

**Print without using the printer driver**

### PRESCRIBE Commands Command Reference

Describes the native printer language (PRESCRIBE commands).

### PRESCRIBE Commands Technical Reference

Describes the PRESCRIBE command functions and control for each type of emulation.

Install the Adobe Reader (version 8.0 or later) to view the manuals on the DVD.

# About the Operation Guide (this Guide)

## Structure of the guide

The Operation Guide contains the following chapters.

Chapter		Contents
1	<b>Legal and Safety Information</b>	Provides precautions regarding use of the machine and trademark information.
2	<b>Installing and Setting up the Machine</b>	Explains part names, cable connections, installation of the software, login, logout, and other matters related to administration of the machine.
3	<b>Preparation before Use</b>	Explains preparations and settings that are required in order to use the machine, such as how to use the operation panel, load paper, and create an address book.
4	<b>Printing from PC</b>	Explains functions that are available when the machine is used as a printer.
5	<b>Operation on the Machine</b>	Explains the basic procedures for using the machine, such as placing originals, making copies, sending documents, and using document boxes.
6	<b>Using Various Functions</b>	Explains convenient functions that are available on the machine.
7	<b>Status/Job Cancel</b>	Explains how to check the status of a job and the job history, and how to cancel jobs being printed or waiting to print. Also explains how to check paper and toner levels, how to check the device status, and how to cancel fax transmission.
8	<b>Setup and Registration (System Menu)</b>	Explains System Menu and how it relates to the operation of the machine.
9	<b>User Authentication and Accounting (User Login, Job Accounting)</b>	Explains user login and job accounting.
10	<b>Troubleshooting</b>	Explains what to do when toner runs out, an error is displayed, or a paper jam or other problem occurs.
11	<b>Appendix</b>	Describes convenient options that are available for the machine. Provides information on media types and paper sizes, and gives a glossary of terms. Explains how to enter characters, and lists the specifications of the machine.

# Conventions Used in This Guide

Adobe Reader XI is used as an example in the explanations below.

Click an item in the Table of Contents to jump to the corresponding page.

Click to move from the current page to the previously displayed page. This is convenient when you want to return to the page from which you jumped to the current page.

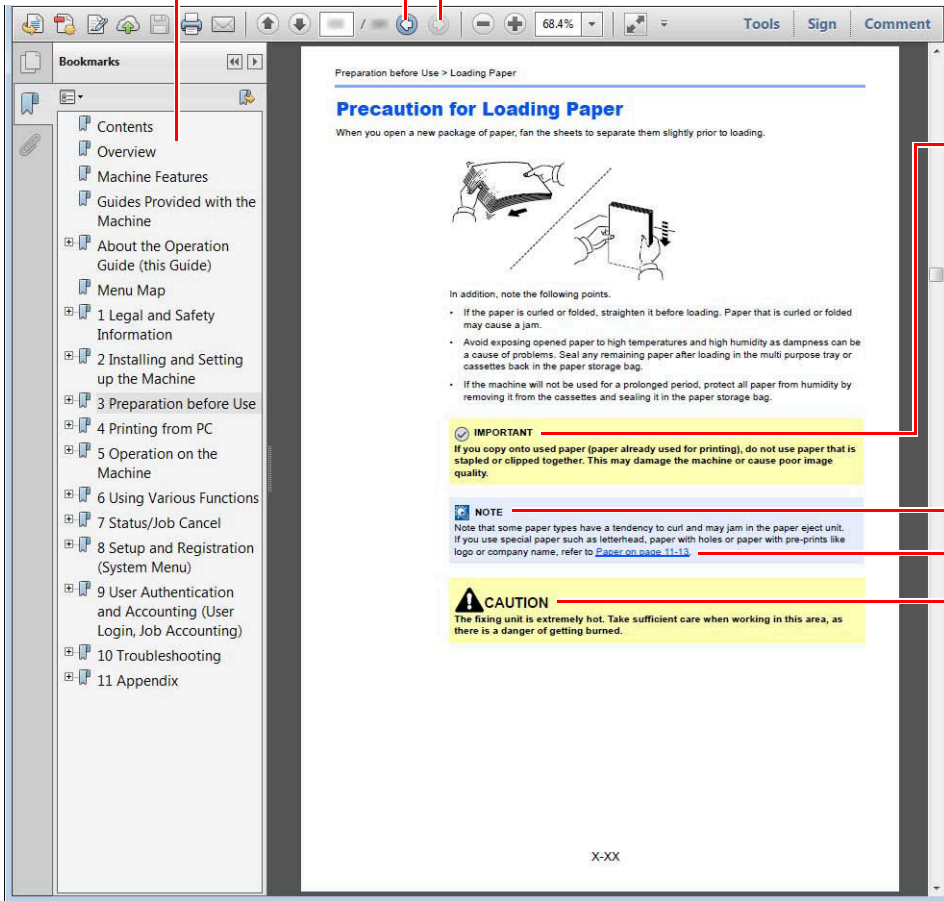

 **IMPORTANT**  
Indicates operational requirements and restrictions to operate the machine correctly, and avoid damage to the machine or property.

 **NOTE**  
Indicates supplemental explanations and reference information for operations.

**Refer to**  
Click the underlined text to jump to the corresponding page.

 **CAUTION**  
Indicates that personal injury or mechanical damage may result from insufficient attention to or incorrect compliance with the related points.

 **NOTE**

The items that appear in Adobe Reader vary depending on how it is used. If the Table of Contents or tools do not appear, refer to Adobe Reader Help.

Certain items are indicated in this guide by the conventions described below.







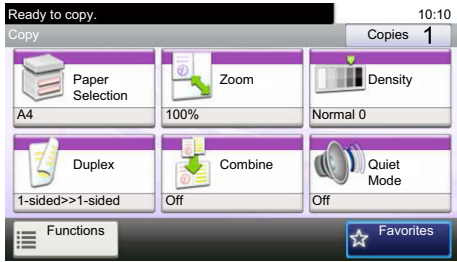

Convention	Description	Example
[ <b>Bold</b> ]	Indicates keys on the operation panel and buttons on your computer screen.	Press the [ <b>Start</b> ] key. Click the [ <b>OK</b> ] button.
[Regular]	Indicates keys on the touch panel.	Press [OK].
"Regular"	Indicates a message or setting displayed on the touch panel or computer screen.	"Ready to copy." appears. You can select from the "Print size" menu.

On pages that explain a convenient function, the modes in which that function can be used are indicated by icons.

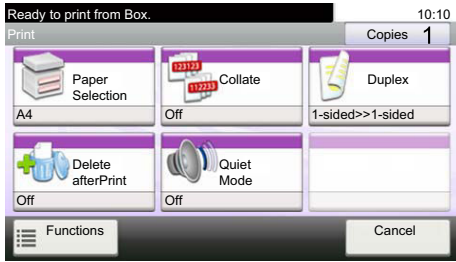
## Quiet Mode

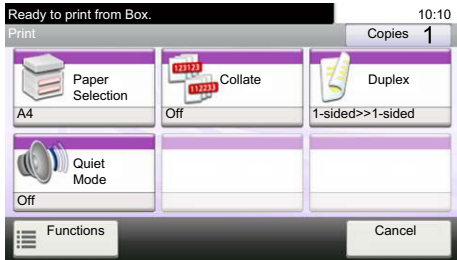

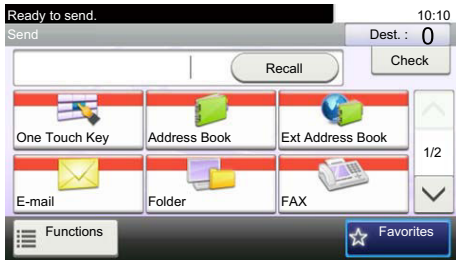
Lower print and scan speed for quiet processing. Select this mode when the running noise is uncomfortable.

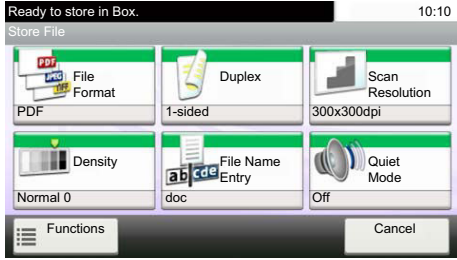
Icon	Description	Icon	Description
	<p>The function can be used when copying a document.</p>  <p>Copy screen</p>		<p>The function can be used when printing from a custom box.</p>  <p>Custom box screen (Option)</p>
	<p>The function can be used when printing from removable memory such as a USB memory stick.</p>  <p>Printing from removable memory screen</p>		<p>The function can be used when sending a document.</p>  <p>Send screen</p>
	<p>The function can be used when saving to removable memory such as a USB memory stick.</p>  <p>Saving to removable memory screen</p>		

## Conventions used in procedures for operating the machine

In this Operation Guide, continuous operation of the keys on the touch panel is as follows:

Actual procedure	Procedure indicated in this guide
Press the [ <b>System Menu</b> ] key ▼ Press [∨] ▼ Press [Common Settings] ▼ Press [Sound]	Press the [ <b>System Menu</b> ] key, [∨], [Common Settings], and then [Sound].

Touch panel keys that are pressed are outlined in red.

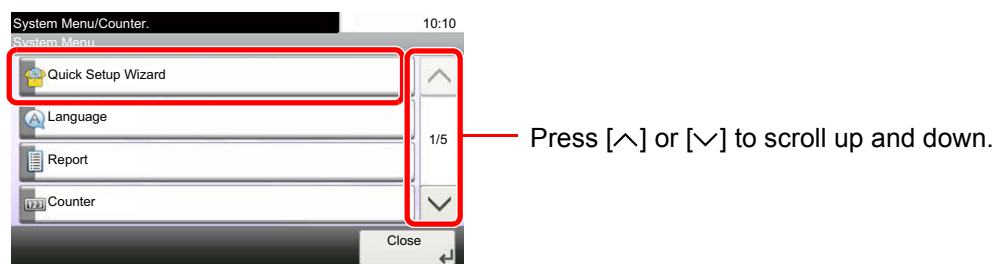

Procedures consisting of a sequence of operation panel or touch panel operations are numbered as shown below.

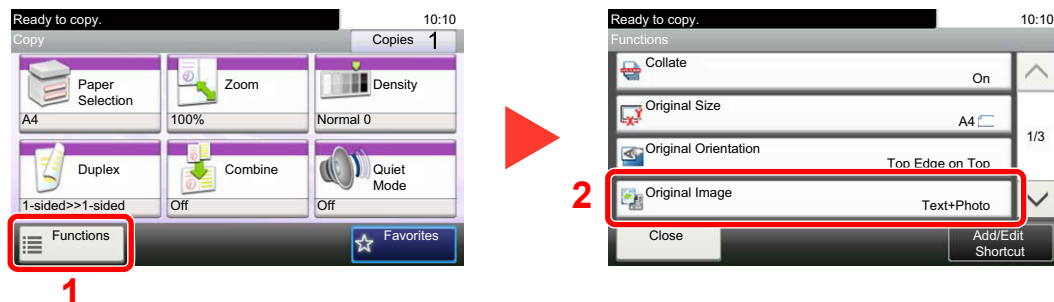

# Menu Map

(The names displayed on the touch panel are used here. These may differ from the referenced titles.)

 Copy

or

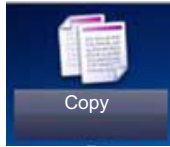

Paper Selection ( <a href="#">page 6-9</a> )	
Zoom ( <a href="#">page 6-14</a> )	
Density ( <a href="#">page 6-11</a> )	
Duplex ( <a href="#">page 6-18</a> )	
Combine ( <a href="#">page 6-16</a> )	
Quiet Mode ( <a href="#">page 6-21</a> )	
<b>Functions</b>	Collate ( <a href="#">page 6-10</a> )
	Original Size ( <a href="#">page 6-8</a> )
	Original Orientation ( <a href="#">page 6-10</a> )
	Original Image ( <a href="#">page 6-11</a> )
	EcoPrint ( <a href="#">page 6-12</a> )
	Sharpness ( <a href="#">page 6-13</a> )
	Background Density Adj. ( <a href="#">page 6-13</a> )
	Prevent Bleed-through ( <a href="#">page 6-14</a> )
	Continuous Scan ( <a href="#">page 6-19</a> )
	Job Finish Notice ( <a href="#">page 6-20</a> )
	File Name Entry ( <a href="#">page 6-21</a> )
	Priority Override ( <a href="#">page 6-21</a> )

 Send



or



One Touch Key ( <a href="#">page 5-24</a> )	
Address Book ( <a href="#">page 5-22</a> )	
Ext Address Book (Refer to <b>Command Center RX User Guide.</b> )	
E-mail ( <a href="#">page 5-25</a> )	
Folder ( <a href="#">page 5-26</a> )	
FAX (Refer to <b>FAX Operation Guide.</b> )	
WSD Scan ( <a href="#">page 5-36</a> )	
<b>Functions</b>	Quiet Mode ( <a href="#">page 6-21</a> )
	File Format ( <a href="#">page 6-24</a> )
	Original Size ( <a href="#">page 6-8</a> )
	Original Orientation ( <a href="#">page 6-10</a> )
	Duplex ( <a href="#">page 6-22</a> )
	Sending Size ( <a href="#">page 6-23</a> )
	File Separation ( <a href="#">page 6-27</a> )
	Scan Resolution ( <a href="#">page 6-27</a> )
	Density ( <a href="#">page 6-11</a> )
	Color Selection ( <a href="#">page 6-12</a> )
	Original Image ( <a href="#">page 6-11</a> )
	Sharpness ( <a href="#">page 6-13</a> )
	Background Density Adj. ( <a href="#">page 6-13</a> )
	Prevent Bleed-through ( <a href="#">page 6-14</a> )
	FAX TX Resolution (Refer to <b>FAX Operation Guide.</b> )
	Zoom ( <a href="#">page 6-14</a> )
	Continuous Scan ( <a href="#">page 6-19</a> )
	File Name Entry ( <a href="#">page 6-21</a> )
	Subject/Body ( <a href="#">page 6-27</a> )
	Job Finish Notice ( <a href="#">page 6-20</a> )
FTP Encrypted TX ( <a href="#">page 6-28</a> )	
FAX Delayed Transmission (Refer to <b>FAX Operation Guide.</b> )	
FAX Direct Transmission (Refer to <b>FAX Operation Guide.</b> )	
FAX Polling RX (Refer to <b>FAX Operation Guide.</b> )	
FAX TX Report (Refer to <b>FAX Operation Guide.</b> )	



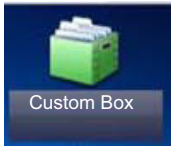

<b>Custom Box</b>	<b>Menu</b>	<b>Print</b>	Paper Selection ( <a href="#">page 6-9</a> )	
			Collate ( <a href="#">page 6-10</a> )	
			Duplex ( <a href="#">page 6-18</a> )	
			Delete after Print ( <a href="#">page 6-28</a> )	
			Quiet Mode ( <a href="#">page 6-21</a> )	
			<b>Functions</b>	Priority Override ( <a href="#">page 6-21</a> )
				File Name Entry ( <a href="#">page 6-21</a> )
				Job Finish Notice ( <a href="#">page 6-20</a> )
				EcoPrint ( <a href="#">page 6-12</a> )

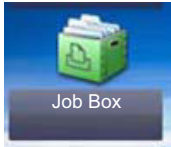

<b>Job Box</b>	Private Print/Stored Job ( <a href="#">page 4-8</a> )
	Quick Copy/Proof and Hold ( <a href="#">page 4-14</a> )

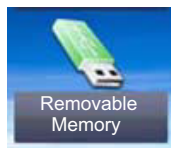

<b>Removable Memory</b>	<b>Print</b>	Paper Selection ( <a href="#">page 6-9</a> )		
		Collate ( <a href="#">page 6-10</a> )		
		Duplex ( <a href="#">page 6-18</a> )		
		Quiet Mode ( <a href="#">page 6-21</a> )		
		<b>Functions</b>	EcoPrint ( <a href="#">page 6-12</a> )	
			Job Finish Notice ( <a href="#">page 6-20</a> )	
			Priority Override ( <a href="#">page 6-21</a> )	
			Encrypted PDF Password ( <a href="#">page 6-29</a> )	
			JPEG/TIFF Print ( <a href="#">page 6-30</a> )	
			XPS Fit to Page ( <a href="#">page 6-30</a> )	
	<b>Menu</b>	<b>Store File</b>	File Format ( <a href="#">page 6-24</a> )	
			Duplex ( <a href="#">page 6-22</a> )	
			Scan Resolution ( <a href="#">page 6-27</a> )	
			Density ( <a href="#">page 6-11</a> )	
			File Name Entry ( <a href="#">page 6-21</a> )	
			Quiet Mode ( <a href="#">page 6-21</a> )	
			<b>Functions</b>	Original Size ( <a href="#">page 6-8</a> )
		Original Orientation ( <a href="#">page 6-10</a> )		
		Storing Size ( <a href="#">page 6-29</a> )		
		Color Selection ( <a href="#">page 6-12</a> )		
Original Image ( <a href="#">page 6-11</a> )				
Sharpness ( <a href="#">page 6-13</a> )				
Background Density Adj. ( <a href="#">page 6-13</a> )				
Prevent Bleed-through ( <a href="#">page 6-14</a> )				
Zoom ( <a href="#">page 6-14</a> )				
Continuous Scan ( <a href="#">page 6-19</a> )				
Job Finish Notice ( <a href="#">page 6-20</a> )				
File Separation ( <a href="#">page 6-27</a> )				

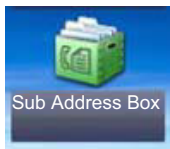

Sub Address Box (Refer to FAX Operation Guide.)



Polling Box (Refer to FAX Operation Guide.)

Status/  
Job Cancel

or

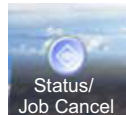

Print Job Status ( <a href="#">page 7-4</a> )
Send Job Status ( <a href="#">page 7-5</a> )
Store Job Status ( <a href="#">page 7-6</a> )
Scheduled Job ( <a href="#">page 7-7</a> )
Print Job Log ( <a href="#">page 7-9</a> )
Send Job Log ( <a href="#">page 7-9</a> )
Store Job Log ( <a href="#">page 7-9</a> )
FAX Job Log (Refer to <b>FAX Operation Guide.</b> )
Scanner ( <a href="#">page 7-13</a> )
Printer ( <a href="#">page 7-13</a> )
FAX (refer to <b>FAX Operation Guide.</b> )
Toner Status ( <a href="#">page 7-15</a> )
Paper Status ( <a href="#">page 7-15</a> )
Removable Memory ( <a href="#">page 7-13</a> )
USB Keyboard ( <a href="#">page 7-13</a> )
SSD ( <a href="#">page 7-14</a> )
Connection Status ( <a href="#">page 7-14</a> )

System Menu / Counter



or

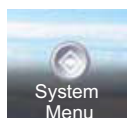

<b>Quick Setup Wizard</b>	FAX Setup ( <a href="#">page 2-17</a> )		
	Paper Setup ( <a href="#">page 2-17</a> )		
	Energy Saver Setup ( <a href="#">page 2-17</a> )		
	Network Setup ( <a href="#">page 2-17</a> )		
<b>Language (<a href="#">page 8-6</a>)</b>			
<b>Report</b>	<b>Print Report</b>	Status Page ( <a href="#">page 8-6</a> )	
		Font List ( <a href="#">page 8-6</a> )	
		Network Status ( <a href="#">page 8-7</a> )	
		Service Status ( <a href="#">page 8-7</a> )	
		Accounting Report ( <a href="#">page 8-7</a> )	
		Sub Address Box List (Refer to <b>FAX Operation Guide.</b> )	
		FAX List (Index) (Refer to <b>FAX Operation Guide.</b> )	
		FAX List (No.) (Refer to <b>FAX Operation Guide.</b> )	
		Outgoing FAX Report (Refer to <b>FAX Operation Guide.</b> )	
		Incoming FAX Report (Refer to <b>FAX Operation Guide.</b> )	
		Optional Network Status ( <a href="#">page 8-7</a> )	
	<b>Admin Report Settings</b>	Outgoing FAX Report (Refer to <b>FAX Operation Guide.</b> )	
		Incoming FAX Report (Refer to <b>FAX Operation Guide.</b> )	
	<b>Result Report Setting</b>	Send Result Report ( <a href="#">page 8-8</a> )	
		RX Result Report (Refer to <b>FAX Operation Guide.</b> )	
		Job Finish Notice Setting ( <a href="#">page 8-8</a> )	
	<b>Send Log History</b>	Sending Log History ( <a href="#">page 8-8</a> )	
		Auto Sending ( <a href="#">page 8-8</a> )	
		Destination ( <a href="#">page 8-8</a> )	
		Job Log Subject ( <a href="#">page 8-8</a> )	
		Personal Information ( <a href="#">page 8-8</a> )	
	<b>Counter</b>	Printed Pages ( <a href="#">page 2-31</a> )	
		Scanned Pages ( <a href="#">page 2-31</a> )	
<b>User Property (<a href="#">page 9-9</a>)</b>			

<b>Cassette/MP Tray Settings</b>	Cassette 1 ( <a href="#">page 8-9</a> )	
	Cassette 2 ( <a href="#">page 8-9</a> )	
	Cassette 3 ( <a href="#">page 8-9</a> )	
	Cassette 4 ( <a href="#">page 8-9</a> )	
	Cassette 5 ( <a href="#">page 8-9</a> )	
	Multi Purpose Tray ( <a href="#">page 8-10</a> )	
<b>Common Settings</b>	Default Screen ( <a href="#">page 8-11</a> )	
	<b>Sound</b>	Buzzer ( <a href="#">page 8-11</a> )
		FAX Speaker Volume (Refer to <b>FAX Operation Guide.</b> )
		FAX Monitor Volume (Refer to <b>FAX Operation Guide.</b> )
	<b>Original Settings</b>	Custom Original Size ( <a href="#">page 8-12</a> )
		Default Original Size ( <a href="#">page 8-12</a> )
	<b>Paper Settings</b>	Custom Paper Size ( <a href="#">page 8-13</a> )
		Media Type Settings ( <a href="#">page 8-14</a> )
		Default Paper Source ( <a href="#">page 8-14</a> )
		Paper Selection ( <a href="#">page 8-14</a> )
		Media for Auto (B & W) ( <a href="#">page 8-14</a> )
		Special Paper Action ( <a href="#">page 8-14</a> )
	<b>Function Defaults</b>	File Format ( <a href="#">page 8-15</a> )
		Original Orientation ( <a href="#">page 8-15</a> )
		Collate ( <a href="#">page 8-15</a> )
		File Separation ( <a href="#">page 8-15</a> )
		Scan Resolution ( <a href="#">page 8-15</a> )
		Color Selection ( <a href="#">page 8-15</a> )
		Original Image (Copy) ( <a href="#">page 8-15</a> )
		Original Image (Send/Store) ( <a href="#">page 8-16</a> )
		Background Density Adj. (Copy) ( <a href="#">page 8-16</a> )
		Background Density Adj. (Send/Store) ( <a href="#">page 8-16</a> )
		EcoPrint ( <a href="#">page 8-16</a> )
		Prevent Bleed-through (Copy) ( <a href="#">page 8-16</a> )
		Prevent Bleed-through (Send/Store) ( <a href="#">page 8-16</a> )
		FAX TX Resolution (Refer to <b>FAX Operation Guide.</b> )
	Zoom ( <a href="#">page 8-16</a> )	

<b>Common Settings</b>	<b>Function Defaults</b>	Continuous Scan (Except FAX) ( <a href="#">page 8-16</a> )	
		Continuous Scan (FAX) (Refer to <b>FAX Operation Guide.</b> )	
		File Name Entry ( <a href="#">page 8-16</a> )	
		Subject/Body ( <a href="#">page 8-16</a> )	
		FTP Encrypted TX ( <a href="#">page 8-16</a> )	
		JPEG/TIFF Print ( <a href="#">page 8-16</a> )	
		XPS Fit to Page ( <a href="#">page 8-16</a> )	
		<b>Detail Settings</b>	Image Quality ( <a href="#">page 8-17</a> )
	PDF/A ( <a href="#">page 8-17</a> )		
	High Comp. PDF ( <a href="#">page 8-17</a> )		
	Preset Limit ( <a href="#">page 8-17</a> )		
	<b>Error Handling</b>	Duplexing Error ( <a href="#">page 8-17</a> )	
		Paper Mismatch Error ( <a href="#">page 8-17</a> )	
	Measurement ( <a href="#">page 8-17</a> )		
	Low Toner Alert Level ( <a href="#">page 8-18</a> )		
	Keyboard Layout ( <a href="#">page 8-18</a> )		
	Format SSD ( <a href="#">page 8-18</a> )		
	Format SD Card ( <a href="#">page 8-19</a> )		
	Display Status/Log ( <a href="#">page 8-19</a> )		
Function Key Usage ( <a href="#">page 8-19</a> )			
<b>Home</b>	Customize Desktop ( <a href="#">page 3-5</a> )		
	Customize Taskbar ( <a href="#">page 3-5</a> )		
	Wallpaper ( <a href="#">page 3-5</a> )		
<b>Copy</b>	Auto Paper Selection ( <a href="#">page 8-20</a> )		
	Auto % Priority ( <a href="#">page 8-20</a> )		
	Reserve Next Priority ( <a href="#">page 8-20</a> )		
	DP Read Action ( <a href="#">page 8-20</a> )		
<b>Send</b>	Dest. Check before Send ( <a href="#">page 8-21</a> )		
	Entry Check for New Dest. ( <a href="#">page 8-21</a> )		
	Send and Forward ( <a href="#">page 8-21</a> )		
	Color TIFF Compression ( <a href="#">page 8-21</a> )		
	Default Screen ( <a href="#">page 8-21</a> )		
	New Destination Entry ( <a href="#">page 8-21</a> )		
	Recall Destination ( <a href="#">page 8-21</a> )		

<b>Document Box</b>	Custom Box ( <a href="#">page 5-43</a> )	
	Sub Address Box (Refer to <b>FAX Operation Guide.</b> )	
	<b>Job Box</b>	Quick Copy Job Retention ( <a href="#">page 8-22</a> )
		Deletion of Job Retention ( <a href="#">page 8-22</a> )
		Storage Media ( <a href="#">page 8-22</a> )
Polling Box (Refer to <b>FAX Operation Guide.</b> )		
<b>FAX (Refer to FAX Operation Guide.)</b>		
<b>Application (<a href="#">page 5-11</a>)</b>		
<b>Internet</b>	Proxy ( <a href="#">page 8-23</a> )	
<b>Address Book/One Touch</b>	Address Book ( <a href="#">page 3-35</a> )	
	One Touch Key ( <a href="#">page 3-41</a> )	
	<b>Address Book Defaults</b>	Sort ( <a href="#">page 8-24</a> )
	Print List (Refer to <b>FAX Operation Guide.</b> )	
<b>User Login/Job Accounting</b>	<b>User Login Settings</b>	User Login ( <a href="#">page 9-3</a> )
		Local User List ( <a href="#">page 9-5</a> )
	<b>ID Card Settings</b>	Keyboard Login ( <a href="#">page 9-30</a> )
		Password Login ( <a href="#">page 9-30</a> )
	<b>Simple login settings</b>	Simple Login ( <a href="#">page 9-25</a> )
		Simple Login Setup ( <a href="#">page 9-26</a> )
	Local User Authorization ( <a href="#">page 9-19</a> )	
	<b>User Account Lockout Settings</b>	Lockout ( <a href="#">page 9-14</a> )
		Lockout Policy ( <a href="#">page 9-14</a> )
		Locked out Users List ( <a href="#">page 9-14</a> )
	<b>Group Authorization Set.</b>	Group Authorization ( <a href="#">page 9-20</a> )
		Group List ( <a href="#">page 9-21</a> )
	Obtain NW User Property ( <a href="#">page 9-23</a> )	

<b>User Login/Job Accounting</b>	<b>Job Accounting Settings</b>	Job Accounting ( <a href="#">page 9-33</a> )	
		Job Accounting Access ( <a href="#">page 9-34</a> )	
		Print Accounting Report ( <a href="#">page 9-47</a> )	
		Total Job Accounting ( <a href="#">page 9-46</a> )	
		Each Job Accounting ( <a href="#">page 9-46</a> )	
		Accounting List ( <a href="#">page 9-35</a> )	
		<b>Default Setting</b>	Apply Limit ( <a href="#">page 9-45</a> )
	Copy/Printer Count ( <a href="#">page 9-45</a> )		
Counter Limit ( <a href="#">page 9-45</a> )			
Unknown ID Job ( <a href="#">page 9-50</a> )			
<b>Printer</b>	Emulation ( <a href="#">page 8-25</a> )		
	EcoPrint ( <a href="#">page 8-25</a> )		
	Override A4/Letter ( <a href="#">page 8-25</a> )		
	Duplex ( <a href="#">page 8-25</a> )		
	Paper Output ( <a href="#">page 8-25</a> )		
	Copies ( <a href="#">page 8-25</a> )		
	Orientation ( <a href="#">page 8-25</a> )		
	Wide A4 ( <a href="#">page 8-25</a> )		
	Form Feed TimeOut ( <a href="#">page 8-25</a> )		
	LF Action ( <a href="#">page 8-26</a> )		
	CR Action ( <a href="#">page 8-26</a> )		
	Job Name ( <a href="#">page 8-26</a> )		
	User Name ( <a href="#">page 8-26</a> )		
	MP Tray Priority ( <a href="#">page 8-26</a> )		
	Paper Feed Mode ( <a href="#">page 8-26</a> )		
	Auto cassette Change ( <a href="#">page 8-26</a> )		
	Resolution ( <a href="#">page 8-26</a> )		
	KIR ( <a href="#">page 8-26</a> )		



<b>System/Network</b>	<b>Network</b>	Host Name ( <a href="#">page 8-27</a> )	
		<b>TCP/IP Settings</b>	TCP/IP ( <a href="#">page 8-27</a> )
			IPv4 Settings ( <a href="#">page 8-27</a> )
			IPv6 Settings ( <a href="#">page 8-28</a> )
			Bonjour ( <a href="#">page 8-28</a> )
			Protocol Detail ( <a href="#">page 8-29</a> )
		WSD Scan ( <a href="#">page 8-30</a> )	
		WSD Print ( <a href="#">page 8-30</a> )	
		Enhanced WSD ( <a href="#">page 8-30</a> )	
		Enhanced WSD (SSL) ( <a href="#">page 8-30</a> )	
		IPSec ( <a href="#">page 8-31</a> )	
		<b>Secure Protocol</b>	SSL ( <a href="#">page 8-31</a> )
			IPP Security ( <a href="#">page 8-31</a> )
			HTTP Security ( <a href="#">page 8-31</a> )
			LDAP Security (Ext. Address Book) ( <a href="#">page 8-31</a> )
			LDAP Security (User Property) ( <a href="#">page 8-31</a> )
			SMTP Security ( <a href="#">page 8-31</a> )
			POP3 Security (User 1) ( <a href="#">page 8-31</a> )
			POP3 Security (User 2) ( <a href="#">page 8-31</a> )
		POP3 Security (User 3) ( <a href="#">page 8-31</a> )	
		LAN Interface ( <a href="#">page 8-31</a> )	
		Restart Network ( <a href="#">page 8-31</a> )	
		Proxy ( <a href="#">page 8-32</a> )	
	<b>Optional Network</b>	Basic ( <a href="#">page 8-32</a> )	
		Wireless Network ( <a href="#">page 8-33</a> )	
	Network Interface (Send) ( <a href="#">page 8-34</a> )		
	<b>Interface Block Setting</b>	USB Host ( <a href="#">page 8-34</a> )	
USB Device ( <a href="#">page 8-34</a> )			
USB Storage ( <a href="#">page 8-34</a> )			
Optional Interface 1 ( <a href="#">page 8-34</a> )			
Optional Interface 2 ( <a href="#">page 8-34</a> )			

<b>System/Network</b>	Security Level ( <a href="#">page 8-35</a> )	
	Restart ( <a href="#">page 8-35</a> )	
	RAM Disk Setting ( <a href="#">page 8-35</a> )	
	Optional Memory ( <a href="#">page 8-36</a> )	
	Data Security ( <a href="#">page 8-36</a> )	
	Optional Function ( <a href="#">page 11-10</a> )	
<b>Date/Timer/Energy Saver</b>	Date/Time ( <a href="#">page 8-37</a> )	
	Date Format ( <a href="#">page 8-37</a> )	
	Time Zone ( <a href="#">page 8-37</a> )	
	Auto Panel Reset ( <a href="#">page 8-37</a> )	
	Panel Reset Timer ( <a href="#">page 8-37</a> )	
	Low Power Timer ( <a href="#">page 8-37</a> )	
	Sleep Rules (models for Europe) ( <a href="#">page 8-38</a> )	
	Sleep Level (models except for Europe) ( <a href="#">page 8-38</a> )	
	Sleep Timer ( <a href="#">page 8-38</a> )	
	Power Off Rule ( <a href="#">page 8-39</a> )	
	Power Off Timer ( <a href="#">page 8-39</a> )	
	Auto Error Clear ( <a href="#">page 8-39</a> )	
	Error Clear Timer ( <a href="#">page 8-39</a> )	
	Unusable Time (Refer to <b>FAX Operation Guide.</b> )	
<b>Adjustment/Maintenance</b>	<b>Quiet Mode Settings</b>	Quiet Mode ( <a href="#">page 8-40</a> )
		Specify for Each Job ( <a href="#">page 8-40</a> )
	<b>Density Adjustment</b>	Copy ( <a href="#">page 8-40</a> )
		Send/Box ( <a href="#">page 8-40</a> )
	<b>Background Density Adj.</b>	Copy (Auto) ( <a href="#">page 8-40</a> )
		Send/Box (Auto) ( <a href="#">page 8-40</a> )
	Print Density ( <a href="#">page 8-40</a> )	
	Auto Color Correction ( <a href="#">page 8-40</a> )	
	Correcting Black Line ( <a href="#">page 8-40</a> )	
	Display Brightness ( <a href="#">page 8-40</a> )	
	Drum Refresh ( <a href="#">page 8-41</a> )	
	Auto Drum Refresh ( <a href="#">page 8-41</a> )	

# 1 Legal and Safety Information

Please read this information before using your machine. This chapter provides information on the following topics.

Notice .....	1-2
Safety Conventions in This Guide .....	1-2
Environment .....	1-3
Precautions for Use .....	1-4
Laser Safety (Europe) .....	1-5
SAFETY OF LASER BEAM (USA) .....	1-6
Safety Instructions Regarding the Disconnection of Power .....	1-7
WARNING .....	1-7
Radio Tag Technology .....	1-7
Other precautions (for users in California, the United States) .....	1-7
Warranty (the United States and Canada) .....	1-8
Legal Restriction on Copying/Scanning .....	1-10
EN ISO 7779 .....	1-10
EK1-ITB 2000 .....	1-10
Legal Information .....	1-11
Energy Saving Control Function .....	1-17
Automatic 2-Sided Copy Function .....	1-17
Resource Saving - Paper .....	1-17
Environmental benefits of "Power Management" .....	1-17
Energy Star (ENERGY STAR®) Program .....	1-18

# Notice

## Safety Conventions in This Guide

The sections of this guide and parts of the machine marked with symbols are safety warnings meant to protect the user, other individuals and surrounding objects, and ensure correct and safe usage of the machine. The symbols and their meanings are indicated below.

 **WARNING:** Indicates that serious injury or even death may result from insufficient attention to or incorrect compliance with the related points.

 **CAUTION:** Indicates that personal injury or mechanical damage may result from insufficient attention to or incorrect compliance with the related points.

## Symbols

The  symbol indicates that the related section includes safety warnings. Specific points of attention are indicated inside the symbol.

 ... [General warning]

 ... [Warning of high temperature]

The  symbol indicates that the related section includes information on prohibited actions. Specifics of the prohibited action are indicated inside the symbol.

 ... [Warning of prohibited action]

 ... [Disassembly prohibited]

The  symbol indicates that the related section includes information on actions which must be performed. Specifics of the required action are indicated inside the symbol.

 ... [Alert of required action]

 ... [Remove the power plug from the outlet]

 ... [Always connect the machine to an outlet with a ground connection]

Please contact your service representative to order a replacement if the safety warnings in this Operation Guide are illegible or if the guide itself is missing (fee required).



### NOTE

An original which resembles a bank note closely may not be copied properly in some rare cases because this machine is equipped with a counterfeiting prevention function.

## Environment

The service environmental conditions are as follows:

- Temperature: 50 to 90.5 °F (10 to 32.5 °C)  
(But humidity should be 70% or less when temperature is 90.5 °F (32.5 °C).)
- Humidity: 15 to 80%  
(But temperature should be 86 °F (30 °C) or less when humidity is 80%.)

Adverse environmental conditions may affect the image quality. It is recommended to use the machine at a temperature: around 60.8 to 80.6 °F or less (16 to 27 °C), humidity: around 36 to 65%.

Avoid the following locations when selecting a site for the machine.

- Avoid locations near a window or with exposure to direct sunlight.
- Avoid locations with vibrations.
- Avoid locations with drastic temperature fluctuations.
- Avoid locations with direct exposure to hot or cold air.
- Avoid poorly ventilated locations.

If the floor is delicate against casters, when this machine is moved after installation, the floor material may be damaged.

During copying, some ozone is released, but the amount does not cause any ill effect to one's health. If, however, the machine is used over a long period of time in a poorly ventilated room or when making an extremely large number of copies, the smell may become unpleasant. To maintain the appropriate environment for copy work, it is suggested that the room be properly ventilated.

## Precautions for Use

### Cautions when handling consumables

#### CAUTION

Do not attempt to incinerate parts which contain toner. Dangerous sparks may cause burns.

Keep parts which contain toner out of the reach of children.

If toner happens to spill from parts which contain toner, avoid inhalation and ingestion, as well as contact with your eyes and skin.

- If you do happen to inhale toner, move to a place with fresh air and gargle thoroughly with a large amount of water. If coughing develops, contact a physician.
- If you do happen to ingest toner, rinse your mouth with water and drink 1 or 2 cups of water to dilute the contents of your stomach. If necessary, contact a physician.
- If you do happen to get toner in your eyes, flush them thoroughly with water. If there is any remaining tenderness, contact a physician.
- If toner does happen to get on your skin, wash with soap and water.

Do not attempt to force open or destroy parts which contain toner.

### Other precautions

Return the exhausted toner container and waste toner box to your dealer or service representative. The collected toner container and waste toner box will be recycled or disposed in accordance with the relevant regulations.

Store the machine while avoiding exposure to direct sunlight.

Store the machine in a place where the temperature stays below 40 °C while avoiding sharp changes of temperature and humidity.

If the machine will not be used for an extended period of time, remove the paper from the cassette and the Multi Purpose (MP) Tray, return it to its original package and reseal it.

## Laser Safety (Europe)

Laser radiation could be hazardous to the human body. For this reason, laser radiation emitted inside this machine is hermetically sealed within the protective housing and external cover. In the normal operation of the product by user, no radiation can leak from the machine.

This machine is classified as Class 1 laser product under IEC/EN 60825-1:2007.

**Caution:** Performance of procedures other than those specified in this manual may result in hazardous radiation exposure.

These labels are attached to the laser scanner unit inside the machine and are not in a user access area.

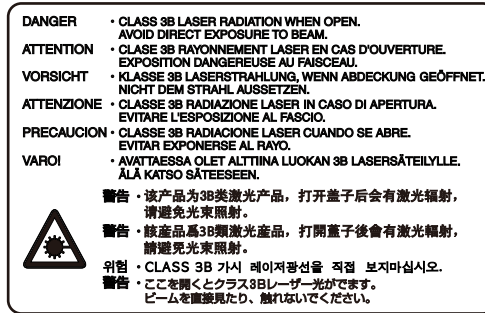

Regarding CLASS 1 laser products, information is provided on the rating label.

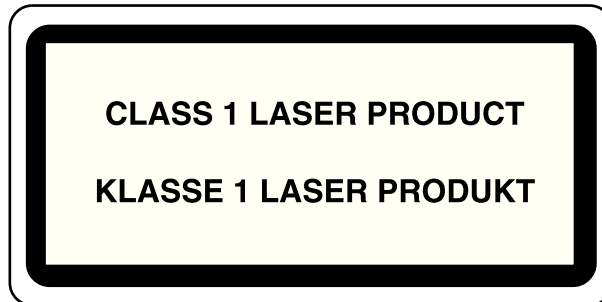

# SAFETY OF LASER BEAM (USA)

## 1. Safety of laser beam

This machine has been certified by the manufacturer to Class 1 level under the radiation performance standards established by the U.S.DHHS (Department of Health and Human Services) in 1968. This indicates that the product is safe to use during normal operation and maintenance. The laser optical system, enclosed in a protective housing and sealed within the external covers, never permits the laser beam to escape.

## 2. The CDRH Act

A laser-product-related act was implemented on Aug. 2, 1976, by the Center for Devices and Radiological Health (CDRH) of the U.S. Food and Drug Administration (FDA). This act prohibits the sale of laser products in the U.S. without certification, and applies to laser products manufactured after Aug. 1, 1976. The label shown below indicates compliance with the CDRH regulations and must be attached to laser products marketed in the United States. On this machine, the label is on the rear.

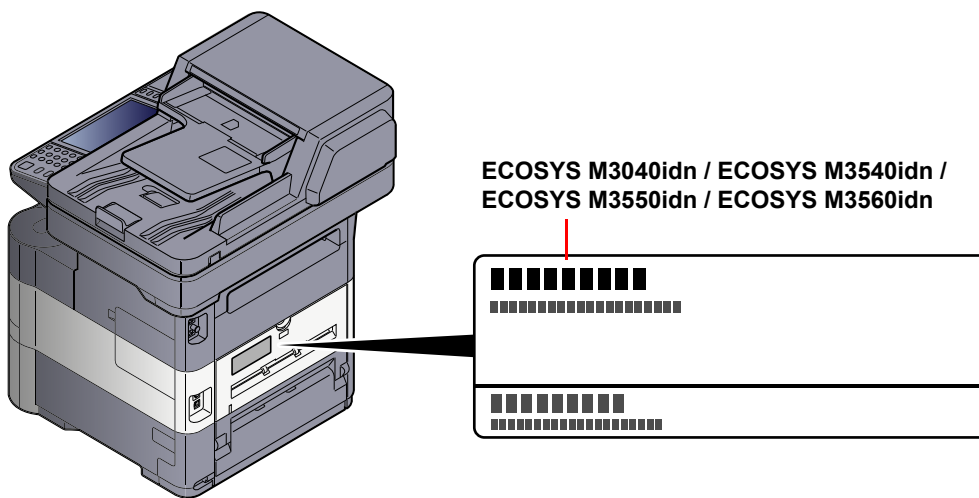

## 3. Optical unit

When checking the optical unit, avoid direct exposure to the laser beam, which is invisible. Shown at below is the label located on the cover of the optical unit.

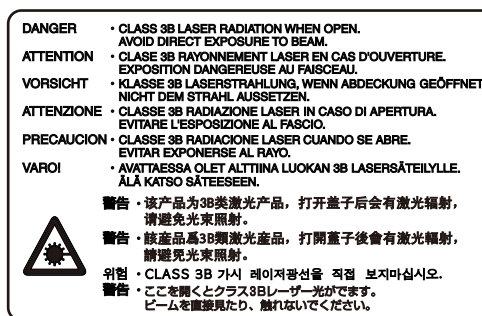

## 4. Maintenance

For safety of the service personnel, follow the maintenance instructions in the other section of this manual.

## 5. Safety switch

The power to the laser unit is cut off when the front cover is opened.



## Safety Instructions Regarding the Disconnection of Power

**Caution:** The power plug is the main isolation device! Other switches on the equipment are only functional switches and are not suitable for isolating the equipment from the power source.

**Attention:** Le débranchement de la fiche secteur est le seul moyen de mettre l'appareil hors tension. Les interrupteurs sur l'appareil ne sont que des interrupteurs de fonctionnement: ils ne mettent pas l'appareil hors tension.

### WARNING

These limits are designed to provide reasonable protection against harmful interference in a residential installation. This equipment generates, uses and can radiate radio frequency energy and, if not installed and used in accordance with the instructions, may cause harmful interference to radio communications. However, there is no guarantee that interference will not occur in a particular installation. If this equipment does cause harmful interference to radio or television reception, which can be determined by turning the equipment off and on, the user is encouraged to try to correct the interference by one or more of the following measures:

- Reorient or relocate the receiving antenna.
- Increase the separation between the equipment and receiver.
- Connect the equipment into an outlet on a circuit different from that to which the receiver is connected.
- Consult the dealer or an experienced radio/TV technician for help.
- The use of a non-shielded interface cable with the referenced device is prohibited.

CAUTION — The changes or modifications not expressly approved by the party responsible for compliance could void the user's authority to operate the equipment.

This device contains the module (FCC ID:, IC:), which complies with Part 15 of FCC Rules and RSS-Gen of IC Rules.

Operation is subject to the following two conditions; (1) this device may not cause interference, and (2) this device must accept any interference, including interference that may cause undesired operation of the device.

### Radio Tag Technology

In some countries the radio tag technology used in this equipment to identify the toner container may be subject to authorization and the use of this equipment may consequently be restricted.

### Other precautions (for users in California, the United States)

Perchlorate Material - special handling may apply. See [www.dtsc.ca.gov/hazardouswaste/perchlorate](http://www.dtsc.ca.gov/hazardouswaste/perchlorate).

## Warranty (the United States and Canada)

### ECOSYS M3040idn / M3540idn MULTIFUNCTIONAL PRODUCT LIMITED WARRANTY

KYOCERA Document Solutions America, Inc. and KYOCERA Document Solutions Canada, Ltd. (both referred to as "KYOCERA") warrant the Customer's new Multifunctional Product (referred to as "MFP"), and the new accessories installed with the initial installation of the MFP, against any defects in material and workmanship for a period of one year, or 300,000 copies/prints from date of installation, whichever first occurs. In the event the MFP or an accessory is found to be defective within the warranty period, KYOCERA's only obligation and the Customer's exclusive remedy shall be replacement of any defective parts. KYOCERA shall have no obligation to furnish labor.

This warranty covers Maintenance Kits and the components of Maintenance Kits included with the original MFP for a period of one year or 300,000 copies/prints, whichever first occurs. Maintenance Kits consist of the developing unit, the drum unit, the fixing unit, the transfer roller, and the paper feed roller. Maintenance Kits for the Document Processor consist of the paper feed roller and the separation pad. Replacement Maintenance Kits have a 90 day Limited Warranty.

This warranty is valid only for the original retail purchaser (referred to as the "Customer") of a new KYOCERA MFP in the United States of America or Canada, based upon the country of purchase.

In order to obtain performance of this warranty, the Customer must immediately notify the Authorized KYOCERA Dealer from whom the product was purchased. If the KYOCERA Dealer is not able to provide service, write to KYOCERA at the address below for the name and address of the Authorized KYOCERA Dealer in your area, or check KYOCERA's website at <http://www.kyoceradocumentsolutions.com> for KYOCERA Document Solutions America, Inc. or <http://www.kyoceradocumentsolutions.ca> for KYOCERA Document Solutions Canada, Ltd.

This warranty does not cover MFPs or accessories which: (a) have become damaged due to operator negligence, misuse, accidents, improper storage or unusual physical or electrical stress, (b) have used parts or supplies which are not genuine KYOCERA brand parts or supplies, (c) have been installed or serviced by a technician not employed by KYOCERA or an Authorized KYOCERA Dealer, or (d) have had the serial number modified, altered, or removed.

This warranty gives the Customer specific legal rights. The Customer may also have other rights, which vary from state to state, or province to province. Neither the seller, nor any other person, is authorized to extend the time period or expand this warranty on behalf of KYOCERA.

THIS WARRANTY IS MADE IN LIEU OF ALL OTHER WARRANTIES AND CONDITIONS, EXPRESS OR IMPLIED, AND KYOCERA SPECIFICALLY DISCLAIMS ANY IMPLIED WARRANTY OR CONDITION OF MERCHANTABILITY OR FITNESS FOR A PARTICULAR PURPOSE. THIS WARRANTY SHALL NOT EXTEND TO, AND KYOCERA SHALL NOT BE LIABLE FOR, ANY INCIDENTAL OR CONSEQUENTIAL DAMAGES WHICH MAY ARISE OUT OF THE USE OF, OR INABILITY TO USE, THE MFP.

**KYOCERA Document Solutions America, Inc.**

225 Sand Road, P.O. Box 40008  
Fairfield, New Jersey 07004-0008, USA

**KYOCERA Document Solutions Canada, Ltd.**

6120 Kestrel Rd., Mississauga, ON L5T 1S8,  
Canada

**ECOSYS M3550idn / M3560idn  
MULTIFUNCTIONAL PRODUCT LIMITED WARRANTY**

KYOCERA Document Solutions America, Inc. and KYOCERA Document Solutions Canada, Ltd. (both referred to as "KYOCERA") warrant the Customer's new Multifunctional Product (referred to as "MFP"), and the new accessories installed with the initial installation of the MFP, against any defects in material and workmanship for a period of one year, or 500,000 copies/prints from date of installation, whichever first occurs. In the event the MFP or an accessory is found to be defective within the warranty period, KYOCERA's only obligation and the Customer's exclusive remedy shall be replacement of any defective parts. KYOCERA shall have no obligation to furnish labor.

This warranty covers Maintenance Kits and the components of Maintenance Kits included with the original MFP for a period of one year or 500,000 copies/prints, whichever first occurs. Maintenance Kits consist of the developing unit, the drum unit, the fixing unit, the transfer roller, and the paper feed roller. Maintenance Kits for the Document Processor consist of the paper feed roller and the separation pad. Replacement Maintenance Kits have a 90 day Limited Warranty.

This warranty is valid only for the original retail purchaser (referred to as the "Customer") of a new KYOCERA MFP in the United States of America or Canada, based upon the country of purchase.

In order to obtain performance of this warranty, the Customer must immediately notify the Authorized KYOCERA Dealer from whom the product was purchased. If the KYOCERA Dealer is not able to provide service, write to KYOCERA at the address below for the name and address of the Authorized KYOCERA Dealer in your area, or check KYOCERA's website at <http://www.kyoceradocumentsolutions.com> for KYOCERA Document Solutions America, Inc. or <http://www.kyoceradocumentsolutions.ca> for KYOCERA Document Solutions Canada, Ltd.

This warranty does not cover MFPs or accessories which: (a) have become damaged due to operator negligence, misuse, accidents, improper storage or unusual physical or electrical stress, (b) have used parts or supplies which are not genuine KYOCERA brand parts or supplies, (c) have been installed or serviced by a technician not employed by KYOCERA or an Authorized KYOCERA Dealer, or (d) have had the serial number modified, altered, or removed.

This warranty gives the Customer specific legal rights. The Customer may also have other rights, which vary from state to state, or province to province. Neither the seller, nor any other person, is authorized to extend the time period or expand this warranty on behalf of KYOCERA.

THIS WARRANTY IS MADE IN LIEU OF ALL OTHER WARRANTIES AND CONDITIONS, EXPRESS OR IMPLIED, AND KYOCERA SPECIFICALLY DISCLAIMS ANY IMPLIED WARRANTY OR CONDITION OF MERCHANTABILITY OR FITNESS FOR A PARTICULAR PURPOSE. THIS WARRANTY SHALL NOT EXTEND TO, AND KYOCERA SHALL NOT BE LIABLE FOR, ANY INCIDENTAL OR CONSEQUENTIAL DAMAGES WHICH MAY ARISE OUT OF THE USE OF, OR INABILITY TO USE, THE MFP.

**KYOCERA Document Solutions America, Inc.**

225 Sand Road, P.O. Box 40008  
Fairfield, New Jersey 07004-0008, USA

**KYOCERA Document Solutions Canada, Ltd.**

6120 Kestrel Rd., Mississauga, ON L5T 1S8,  
Canada

## **Legal Restriction on Copying/Scanning**

It may be prohibited to copy/scan copyrighted material without permission of the copyright owner.

Copying/Scanning the following items is prohibited and may be penalized by law. It may not be limited to these items. Do not knowingly copy/scan the items that are not to be copied/scanned.

- Paper money
- Bank note
- Securities
- Stamp
- Passport
- Certificate

Local laws and regulations may prohibit or restrict copying/scanning of other items not mentioned above.

## **EN ISO 7779**

Maschinenlärminformations-Verordnung 3. GPSGV, 06.01.2004: Der höchste Schalldruckpegel beträgt 70 dB (A) oder weniger gemäß EN ISO 7779.

## **EK1-ITB 2000**

Das Gerät ist nicht für die Benutzung im unmittelbaren Gesichtsfeld am Bildschirmarbeitsplatz vorgesehen. Um störende Reflexionen am Bildschirmarbeitsplatz zu vermeiden, darf dieses Produkt nicht im unmittelbaren Gesichtsfeld platziert werden.

## Legal Information

Copying or other reproduction of all or part of this guide without the prior written consent of KYOCERA Document Solutions Inc. is prohibited.

### Regarding Trade Names

- PRESCRIBE is a registered trademark of Kyocera Corporation.
- KPDL is a trademark of Kyocera Corporation.
- Microsoft, Windows, Windows XP, Windows Server 2003, Windows Vista, Windows Server 2008, Windows 7, Windows Server 2012, Windows 8 and Internet Explorer are registered trademarks or trademarks of Microsoft Corporation in the U.S.A. and/or other countries.
- PCL is a trademark of Hewlett-Packard Company.
- Adobe Acrobat, Adobe Reader and PostScript are trademarks of Adobe Systems, Incorporated.
- Ethernet is a registered trademark of Xerox Corporation.
- IBM and IBM PC/AT are trademarks of International Business Machines Corporation.
- AppleTalk, Bonjour, Macintosh, and Mac OS are trademarks of Apple Inc., registered in the U.S. and other countries.
- TypeBankG-B, TypeBankM-M and Typebank-OCR are trademarks of TypeBank®.
- All European language fonts installed in this machine are used under licensing agreement with Monotype Imaging Inc.
- Helvetica, Palatino and Times are registered trademarks of Linotype GmbH.
- ITC Avant Garde Gothic, ITC Bookman, ITC ZapfChancery and ITC ZapfDingbats are registered trademarks of International Typeface Corporation.
- ThinPrint is a trademark of Cortado AG in Germany and other countries.
- UFST™ MicroType® fonts by Monotype Imaging Inc. are installed in this machine.
- This machine contains the software having modules developed by Independent JPEG Group.
- This product contains NetFront Browser of ACCESS CO., LTD.
- ACCESS, ACCESS logo and NetFront are trademarks or registered trademarks of ACCESS CO., LTD. in the United States, Japan and other countries.
- © 2011 ACCESS CO., LTD. All rights reserved.
- Java is a registered trademark of Oracle and/or its affiliates.

**ACCESS™**  
**NetFront™ Browser**



- iPad, iPhone and iPod touch are trademarks of Apple Inc., registered in the U.S. and other countries.
- AirPrint and the AirPrint logo are trademarks of Apple Inc.
- iOS is a trademark or registered trademark of Cisco in the U.S. and other countries and is used under license by Apple Inc.

All other brands and product names are registered trademarks or trademarks designations ™ and ® will not be used in this Operation Guide.

## GPL/LGPL

This product contains GPL (<http://www.gnu.org/licenses/gpl.html>) and/or LGPL (<http://www.gnu.org/licenses/lgpl.html>) software as part of its firmware. You can get the source code, and you are permitted to copy, redistribute and modify it under the terms of GPL/LGPL. For further information including availability of the source code, visit <http://www.kyoceradocumentsolutions.com/gpl/>.

## OpenSSL License

Copyright (c) 1998-2006 The OpenSSL Project. All rights reserved.

Redistribution and use in source and binary forms, with or without modification, are permitted provided that the following conditions are met:

1. Redistributions of source code must retain the above copyright notice, this list of conditions and the following disclaimer.
2. Redistributions in binary form must reproduce the above copyright notice, this list of conditions and the following disclaimer in the documentation and/or other materials provided with the distribution.
3. All advertising materials mentioning features or use of this software must display the following acknowledgment: "This product includes software developed by the OpenSSL Project for use in the OpenSSL Toolkit. (<http://www.openssl.org/>)"
4. The names "OpenSSL Toolkit" and "OpenSSL Project" must not be used to endorse or promote products derived from this software without prior written permission. For written permission, please contact [openssl-core@openssl.org](mailto:openssl-core@openssl.org).
5. Products derived from this software may not be called "OpenSSL" nor may "OpenSSL" appear in their names without prior written permission of the OpenSSL Project.
6. Redistributions of any form whatsoever must retain the following acknowledgment: "This product includes software developed by the OpenSSL Project for use in the OpenSSL Toolkit (<http://www.openssl.org/>)"

THIS SOFTWARE IS PROVIDED BY THE OpenSSL PROJECT "AS IS" AND ANY EXPRESSED OR IMPLIED WARRANTIES, INCLUDING, BUT NOT LIMITED TO, THE IMPLIED WARRANTIES OF MERCHANTABILITY AND FITNESS FOR A PARTICULAR PURPOSE ARE DISCLAIMED. IN NO EVENT SHALL THE OpenSSL PROJECT OR ITS CONTRIBUTORS BE LIABLE FOR ANY DIRECT, INDIRECT, INCIDENTAL, SPECIAL, EXEMPLARY, OR CONSEQUENTIAL DAMAGES (INCLUDING, BUT NOT LIMITED TO, PROCUREMENT OF SUBSTITUTE GOODS OR SERVICES; LOSS OF USE, DATA, OR PROFITS; OR BUSINESS INTERRUPTION) HOWEVER CAUSED AND ON ANY THEORY OF LIABILITY, WHETHER IN CONTRACT, STRICT LIABILITY, OR TORT (INCLUDING NEGLIGENCE OR OTHERWISE) ARISING IN ANY WAY OUT OF THE USE OF THIS SOFTWARE, EVEN IF ADVISED OF THE POSSIBILITY OF SUCH DAMAGE.

## Original SSLeay License

Copyright (C) 1995-1998 Eric Young ([ey@cryptsoft.com](mailto:ey@cryptsoft.com)) All rights reserved.

This package is an SSL implementation written by Eric Young ([ey@cryptsoft.com](mailto:ey@cryptsoft.com)). The implementation was written so as to conform with Netscapes SSL.

This library is free for commercial and non-commercial use as long as the following conditions are adhered to. The following conditions apply to all code found in this distribution, be it the RC4, RSA, lhash, DES, etc., code; not just the SSL code. The SSL documentation included with this distribution is covered by the same copyright terms except that the holder is Tim Hudson ([tjh@cryptsoft.com](mailto:tjh@cryptsoft.com)).

Copyright remains Eric Young's, and as such any Copyright notices in the code are not to be removed.

If this package is used in a product, Eric Young should be given attribution as the author of the parts of the library used.

This can be in the form of a textual message at program startup or in documentation (online or textual) provided with the package.

Redistribution and use in source and binary forms, with or without modification, are permitted provided that the following conditions are met:

1. Redistributions of source code must retain the copyright notice, this list of conditions and the following disclaimer.
2. Redistributions in binary form must reproduce the above copyright notice, this list of conditions and the following disclaimer in the documentation and/or other materials provided with the distribution.
3. All advertising materials mentioning features or use of this software must display the following acknowledgement:  
"This product includes cryptographic software written by Eric Young (eay@cryptsoft.com)"  
The word 'cryptographic' can be left out if the routines from the library being used are not cryptographic related :-).
4. If you include any Windows specific code (or a derivative thereof) from the apps directory (application code) you must include an acknowledgement: "This product includes software written by Tim Hudson (tjh@cryptsoft.com)"

THIS SOFTWARE IS PROVIDED BY ERIC YOUNG "AS IS" AND ANY EXPRESS OR IMPLIED WARRANTIES, INCLUDING, BUT NOT LIMITED TO, THE IMPLIED WARRANTIES OF MERCHANTABILITY AND FITNESS FOR A PARTICULAR PURPOSE ARE DISCLAIMED. IN NO EVENT SHALL THE AUTHOR OR CONTRIBUTORS BE LIABLE FOR ANY DIRECT, INDIRECT, INCIDENTAL, SPECIAL, EXEMPLARY, OR CONSEQUENTIAL DAMAGES (INCLUDING, BUT NOT LIMITED TO, PROCUREMENT OF SUBSTITUTE GOODS OR SERVICES; LOSS OF USE, DATA, OR PROFITS; OR BUSINESS INTERRUPTION) HOWEVER CAUSED AND ON ANY THEORY OF LIABILITY, WHETHER IN CONTRACT, STRICT LIABILITY, OR TORT (INCLUDING NEGLIGENCE OR OTHERWISE) ARISING IN ANY WAY OUT OF THE USE OF THIS SOFTWARE, EVEN IF ADVISED OF THE POSSIBILITY OF SUCH DAMAGE.

The licence and distribution terms for any publically available version or derivative of this code cannot be changed. i.e. this code cannot simply be copied and put under another distribution licence [including the GNU Public Licence.]

### **Monotype Imaging License Agreement**

- 1 *Software* shall mean the digitally encoded, machine readable, scalable outline data as encoded in a special format as well as the UFST Software.
- 2 You agree to accept a non-exclusive license to use the Software to reproduce and display weights, styles and versions of letters, numerals, characters and symbols (*Typefaces*) solely for your own customary business or personal purposes at the address stated on the registration card you return to Monotype Imaging. Under the terms of this License Agreement, you have the right to use the Fonts on up to three printers. If you need to have access to the fonts on more than three printers, you need to acquire a multiuser license agreement which can be obtained from Monotype Imaging. Monotype Imaging retains all rights, title and interest to the Software and Typefaces and no rights are granted to you other than a License to use the Software on the terms expressly set forth in this Agreement.
- 3 To protect proprietary rights of Monotype Imaging, you agree to maintain the Software and other proprietary information concerning the Typefaces in strict confidence and to establish reasonable procedures regulating access to and use of the Software and Typefaces.
- 4 You agree not to duplicate or copy the Software or Typefaces, except that you may make one backup copy. You agree that any such copy shall contain the same proprietary notices as those appearing on the original.
- 5 This License shall continue until the last use of the Software and Typefaces, unless sooner terminated. This License may be terminated by Monotype Imaging if you fail to comply with the terms of this License and such failure is not remedied within thirty (30) days after notice from Monotype Imaging. When this License expires or is terminated, you shall either return to Monotype Imaging or destroy all copies of the Software and Typefaces and documentation as requested.
- 6 You agree that you will not modify, alter, disassemble, decrypt, reverse engineer or decompile the Software.
- 7 Monotype Imaging warrants that for ninety (90) days after delivery, the Software will perform in accordance with Monotype Imaging-published specifications, and the diskette will be free from defects in material and workmanship. Monotype Imaging does not warrant that the Software is free from all bugs, errors and omissions.  
  
The parties agree that all other warranties, expressed or implied, including warranties of fitness for a particular purpose and merchantability, are excluded.
- 8 Your exclusive remedy and the sole liability of Monotype Imaging in connection with the Software and Typefaces is repair or replacement of defective parts, upon their return to Monotype Imaging.  
  
In no event will Monotype Imaging be liable for lost profits, lost data, or any other incidental or consequential damages, or any damages caused by abuse or misapplication of the Software and Typefaces.
- 9 Massachusetts U.S.A. law governs this Agreement.



- 10 You shall not sublicense, sell, lease, or otherwise transfer the Software and/or Typefaces without the prior written consent of Monotype Imaging.
- 11 Use, duplication or disclosure by the Government is subject to restrictions as set forth in the Rights in Technical Data and Computer Software clause at FAR 252-227-7013, subdivision (b)(3)(ii) or subparagraph (c)(1)(ii), as appropriate. Further use, duplication or disclosure is subject to restrictions applicable to restricted rights software as set forth in FAR 52.227-19 (c)(2).
- 12 You acknowledge that you have read this Agreement, understand it, and agree to be bound by its terms and conditions. Neither party shall be bound by any statement or representation not contained in this Agreement. No change in this Agreement is effective unless written and signed by properly authorized representatives of each party. By opening this diskette package, you agree to accept the terms and conditions of this Agreement.

### **Knopflerfish License**

This product includes software developed by the Knopflerfish Project.

<http://www.knopflerfish.org>

Copyright 2003-2010 The Knopflerfish Project. All rights reserved.

Redistribution and use in source and binary forms, with or without modification, are permitted provided that the following conditions are met:

- Redistributions of source code must retain the above copyright notice, this list of conditions and the following disclaimer.
- Redistributions in binary form must reproduce the above copyright notice, this list of conditions and the following disclaimer in the documentation and/or other materials provided with the distribution.
- Neither the name of the KNOPFLERFISH project nor the names of its contributors may be used to endorse or promote products derived from this software without specific prior written permission.

THIS SOFTWARE IS PROVIDED BY THE COPYRIGHT HOLDERS AND CONTRIBUTORS "AS IS" AND ANY EXPRESS OR IMPLIED WARRANTIES, INCLUDING, BUT NOT LIMITED TO, THE IMPLIED WARRANTIES OF MERCHANTABILITY AND FITNESS FOR A PARTICULAR PURPOSE ARE DISCLAIMED. IN NO EVENT SHALL THE COPYRIGHT OWNER OR CONTRIBUTORS BE LIABLE FOR ANY DIRECT, INDIRECT, INCIDENTAL, SPECIAL, EXEMPLARY, OR CONSEQUENTIAL DAMAGES (INCLUDING, BUT NOT LIMITED TO, PROCUREMENT OF SUBSTITUTE GOODS OR SERVICES; LOSS OF USE, DATA, OR PROFITS; OR BUSINESS INTERRUPTION) HOWEVER CAUSED AND ON ANY THEORY OF LIABILITY, WHETHER IN CONTRACT, STRICT LIABILITY, OR TORT (INCLUDING NEGLIGENCE OR OTHERWISE) ARISING IN ANY WAY OUT OF THE USE OF THIS SOFTWARE, EVEN IF ADVISED OF THE POSSIBILITY OF SUCH DAMAGE.

### **Apache License (Version 2.0)**

Apache License  
Version 2.0, January 2004  
<http://www.apache.org/licenses/>

#### **TERMS AND CONDITIONS FOR USE, REPRODUCTION, AND DISTRIBUTION**

##### **1. Definitions.**

"License" shall mean the terms and conditions for use, reproduction, and distribution as defined by Sections 1 through 9 of this document.

"Licensor" shall mean the copyright owner or entity authorized by the copyright owner that is granting the License.

"Legal Entity" shall mean the union of the acting entity and all other entities that control, are controlled by, or are under common control with that entity. For the purposes of this definition, "control" means (i) the power, direct or indirect, to cause the direction or management of such entity, whether by contract or otherwise, or (ii) ownership of fifty percent (50%) or more of the outstanding shares, or (iii) beneficial ownership of such entity.

"You" (or "Your") shall mean an individual or Legal Entity exercising permissions granted by this License.

"Source" form shall mean the preferred form for making modifications, including but not limited to software source code, documentation source, and configuration files.



"Object" form shall mean any form resulting from mechanical transformation or translation of a Source form, including but not limited to compiled object code, generated documentation, and conversions to other media types.

"Work" shall mean the work of authorship, whether in Source or Object form, made available under the License, as indicated by a copyright notice that is included in or attached to the work (an example is provided in the Appendix below).

"Derivative Works" shall mean any work, whether in Source or Object form, that is based on (or derived from) the Work and for which the editorial revisions, annotations, elaborations, or other modifications represent, as a whole, an original work of authorship. For the purposes of this License, Derivative Works shall not include works that remain separable from, or merely link (or bind by name) to the interfaces of, the Work and Derivative Works thereof.

"Contribution" shall mean any work of authorship, including the original version of the Work and any modifications or additions to that Work or Derivative Works thereof, that is intentionally submitted to Licensor for inclusion in the Work by the copyright owner or by an individual or Legal Entity authorized to submit on behalf of the copyright owner. For the purposes of this definition, "submitted" means any form of electronic, verbal, or written communication sent to the Licensor or its representatives, including but not limited to communication on electronic mailing lists, source code control systems, and issue tracking systems that are managed by, or on behalf of, the Licensor for the purpose of discussing and improving the Work, but excluding communication that is conspicuously marked or otherwise designated in writing by the copyright owner as "Not a Contribution."

"Contributor" shall mean Licensor and any individual or Legal Entity on behalf of whom a Contribution has been received by Licensor and subsequently incorporated within the Work.

2. Grant of Copyright License. Subject to the terms and conditions of this License, each Contributor hereby grants to You a perpetual, worldwide, non-exclusive, no-charge, royalty-free, irrevocable copyright license to reproduce, prepare Derivative Works of, publicly display, publicly perform, sublicense, and distribute the Work and such Derivative Works in Source or Object form.
3. Grant of Patent License. Subject to the terms and conditions of this License, each Contributor hereby grants to You a perpetual, worldwide, non-exclusive, no-charge, royalty-free, irrevocable (except as stated in this section) patent license to make, have made, use, offer to sell, sell, import, and otherwise transfer the Work, where such license applies only to those patent claims licensable by such Contributor that are necessarily infringed by their Contribution(s) alone or by combination of their Contribution(s) with the Work to which such Contribution(s) was submitted. If You institute patent litigation against any entity (including a cross-claim or counterclaim in a lawsuit) alleging that the Work or a Contribution incorporated within the Work constitutes direct or contributory patent infringement, then any patent licenses granted to You under this License for that Work shall terminate as of the date such litigation is filed.
4. Redistribution. You may reproduce and distribute copies of the Work or Derivative Works thereof in any medium, with or without modifications, and in Source or Object form, provided that You meet the following conditions:
  - (a) You must give any other recipients of the Work or Derivative Works a copy of this License; and
  - (b) You must cause any modified files to carry prominent notices stating that You changed the files; and
  - (c) You must retain, in the Source form of any Derivative Works that You distribute, all copyright, patent, trademark, and attribution notices from the Source form of the Work, excluding those notices that do not pertain to any part of the Derivative Works; and
  - (d) If the Work includes a "NOTICE" text file as part of its distribution, then any Derivative Works that You distribute must include a readable copy of the attribution notices contained within such NOTICE file, excluding those notices that do not pertain to any part of the Derivative Works, in at least one of the following places: within a NOTICE text file distributed as part of the Derivative Works; within the Source form or documentation, if provided along with the Derivative Works; or, within a display generated by the Derivative Works, if and wherever such third-party notices normally appear. The contents of the NOTICE file are for informational purposes only and do not modify the License. You may add Your own attribution notices within Derivative Works that You distribute, alongside or as an addendum to the NOTICE text from the Work, provided that such additional attribution notices cannot be construed as modifying the License.

You may add Your own copyright statement to Your modifications and may provide additional or different license terms and conditions for use, reproduction, or distribution of Your modifications, or for any such Derivative Works as a whole, provided Your use, reproduction, and distribution of the Work otherwise complies with the conditions stated in this License.

5. **Submission of Contributions.** Unless You explicitly state otherwise, any Contribution intentionally submitted for inclusion in the Work by You to the Licensor shall be under the terms and conditions of this License, without any additional terms or conditions. Notwithstanding the above, nothing herein shall supersede or modify the terms of any separate license agreement you may have executed with Licensor regarding such Contributions.
6. **Trademarks.** This License does not grant permission to use the trade names, trademarks, service marks, or product names of the Licensor, except as required for reasonable and customary use in describing the origin of the Work and reproducing the content of the NOTICE file.
7. **Disclaimer of Warranty.** Unless required by applicable law or agreed to in writing, Licensor provides the Work (and each Contributor provides its Contributions) on an "AS IS" BASIS, WITHOUT WARRANTIES OR CONDITIONS OF ANY KIND, either express or implied, including, without limitation, any warranties or conditions of TITLE, NON-INFRINGEMENT, MERCHANTABILITY, or FITNESS FOR A PARTICULAR PURPOSE. You are solely responsible for determining the appropriateness of using or redistributing the Work and assume any risks associated with Your exercise of permissions under this License.
8. **Limitation of Liability.** In no event and under no legal theory, whether in tort (including negligence), contract, or otherwise, unless required by applicable law (such as deliberate and grossly negligent acts) or agreed to in writing, shall any Contributor be liable to You for damages, including any direct, indirect, special, incidental, or consequential damages of any character arising as a result of this License or out of the use or inability to use the Work (including but not limited to damages for loss of goodwill, work stoppage, computer failure or malfunction, or any and all other commercial damages or losses), even if such Contributor has been advised of the possibility of such damages.
9. **Accepting Warranty or Additional Liability.** While redistributing the Work or Derivative Works thereof, You may choose to offer, and charge a fee for, acceptance of support, warranty, indemnity, or other liability obligations and/or rights consistent with this License. However, in accepting such obligations, You may act only on Your own behalf and on Your sole responsibility, not on behalf of any other Contributor, and only if You agree to indemnify, defend, and hold each Contributor harmless for any liability incurred by, or claims asserted against, such Contributor by reason of your accepting any such warranty or additional liability.

END OF TERMS AND CONDITIONS

APPENDIX: How to apply the Apache License to your work.

To apply the Apache License to your work, attach the following boilerplate notice, with the fields enclosed by brackets "[ ]" replaced with your own identifying information. (Don't include the brackets!) The text should be enclosed in the appropriate comment syntax for the file format. We also recommend that a file or class name and description of purpose be included on the same "printed page" as the copyright notice for easier identification within third-party archives.

Copyright [yyyy] [name of copyright owner]

Licensed under the Apache License, Version 2.0 (the "License"); you may not use this file except in compliance with the License. You may obtain a copy of the License at

<http://www.apache.org/licenses/LICENSE-2.0>

Unless required by applicable law or agreed to in writing, software distributed under the License is distributed on an "AS IS" BASIS, WITHOUT WARRANTIES OR CONDITIONS OF ANY KIND, either express or implied. See the License for the specific language governing permissions and limitations under the License.

## Energy Saving Control Function

The device comes equipped with a **Low Power Mode** where energy consumption is reduced after a certain amount of time elapses since the device was last used, as well as a **Sleep** where printer and fax functions remain in a waiting state but power consumption is still reduced to a minimum when there is no activity with the device within a set amount of time. In addition, the device comes equipped with a **Power Off Mode** where the device automatically turns off after a certain amount of time elapses the device was last used.

### Low Power Mode

The device automatically enters Low Power Mode when 1 minute has passed since the device was last used. The amount of time of no activity that must pass before Low Power Mode is activated may be lengthened. For more information refer to [Low Power Mode and Auto Low Power Mode \(page 2-14\)](#).

### Sleep

The device automatically enters Sleep when 1 minute has passed since the device was last used. The amount of time of no activity that must pass before Sleep is activated may be lengthened. For more information see [Sleep and Auto Sleep \(page 2-15\)](#).

### Power Off Mode

The device automatically turns its power off when 1 hour has passed since the device was last used. The amount of time of no activity that must pass before Power Off Mode is activated may be lengthened by changing the Power Off Timer setting. You can also select rules whether the machine enters Power Off Mode for functions individually. For more information see [Power Off Rule \(page 8-39\)](#) and [Power Off Timer \(page 8-39\)](#).

## Automatic 2-Sided Copy Function

This device includes 2-sided copying as a standard function. For example, by copying two 1-sided originals onto a single sheet of paper as a 2-sided copy, it is possible to lower the amount of paper used. For more information refer to [Duplex \(page 6-18\)](#).

Printing in duplex mode reduces paper consumption and contributes to the conservation of forest resources. Duplex mode also reduces the amount of paper that must be purchased, and thereby reduces cost. It is recommended that machines capable of duplex printing be set to use duplex mode by default.

## Resource Saving - Paper

For the preservation and sustainable use of forest resources, it is recommended that recycled as well as virgin paper certified under environmental stewardship initiatives or carrying recognised ecolabels, which meet EN 12281:2002\* or an equivalent quality standard, be used.

This machine also supports printing on 64 g/m<sup>2</sup> paper. Using such paper containing less raw materials can lead to further saving of forest resources.

\* : EN12281:2002 "Printing and business paper - Requirements for copy paper for dry toner imaging processes"

Your sales or service representative can provide information about recommended paper types.

## Environmental benefits of "Power Management"

To reduce power consumption when idle, this machine is equipped with a power management function that automatically activates energy-saving mode when the machine is idle for a certain period of time.

Although it takes the machine a slight amount of time to return to READY mode when in energy-saving mode, a significant reduction in energy consumption is possible. It is recommended that the machine be used with the activation time for energy-saving mode set to the default setting.

## Energy Star (ENERGY STAR®) Program



We have determined as a participating company in the International Energy Star Program that this product is compliant with the standards laid out in the International Energy Star Program.

ENERGY STAR® is a voluntary energy efficiency program with the goal of developing and promoting the use of products with high energy efficiency in order to help prevent global warming. By purchasing

ENERGY STAR® qualified products, customers can help reduce emissions of greenhouse gases during product use and cut energy-related costs.

# 2 Installing and Setting up the Machine

This chapter provides information for the administrator of this machine, such as part names, cable connection, and software installation.

Part Names .....	2-2
Machine Exterior .....	2-2
Connectors/Interior .....	2-3
With Optional Equipments Attached .....	2-4
Connecting the Machine and Other Devices .....	2-5
Connecting Cables .....	2-6
Connecting LAN Cable .....	2-6
Connecting USB Cable .....	2-7
Connecting the Power Cable .....	2-7
Power On/Off .....	2-8
Power On .....	2-8
Power Off .....	2-8
Login/Logout .....	2-9
Login .....	2-9
Logout .....	2-10
Default Settings of the Machine .....	2-11
Setting Date and Time .....	2-11
Network Setup (LAN Cable Connection) .....	2-13
Energy Saver function .....	2-14
Low Power Mode and Auto Low Power Mode .....	2-14
Sleep and Auto Sleep .....	2-15
Quick Setup Wizard .....	2-17
Installing Software .....	2-20
Software on DVD (Windows) .....	2-20
Installing Software in Windows .....	2-21
Uninstalling the Software .....	2-26
Installing Software in Mac Computer .....	2-27
Setting TWAIN Driver .....	2-29
Setting WIA Driver .....	2-30
Checking the Counter .....	2-31
Additional Preparations for the Administrator .....	2-32
Sending Documents to a PC .....	2-32
Strengthening the Security .....	2-32
Command Center RX .....	2-34
Accessing Command Center RX .....	2-35
Changing Security Settings .....	2-37
Changing Device Information .....	2-39
E-mail Settings .....	2-41
Registering Destinations .....	2-45
Creating a New Custom Box .....	2-47
Printing a document stored in a Custom Box .....	2-48
Transferring Data from Our Other Products .....	2-50
Migrating the Address Book .....	2-50

# Part Names

## Machine Exterior

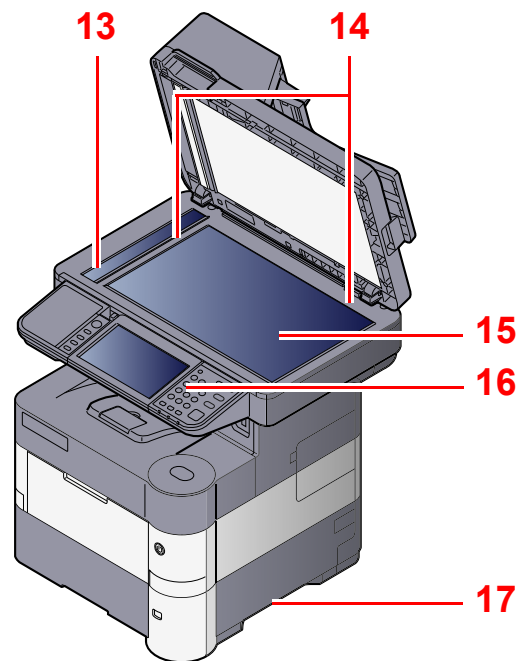
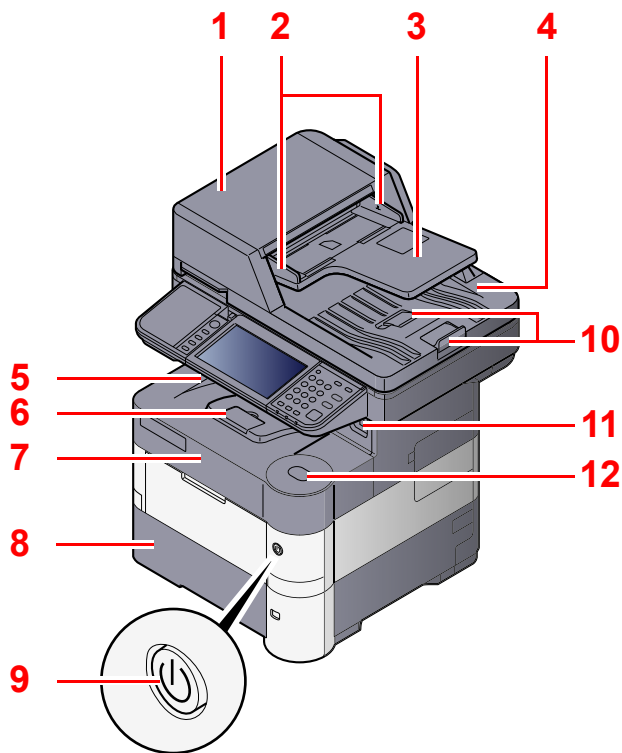

- 1 Document Processor
- 2 Original Width Guides
- 3 Original Table
- 4 Original Eject Table
- 5 Inner Tray
- 6 Paper Stopper
- 7 Front Cover
- 8 Cassette 1
- 9 Power Switch

- 10 Original Stopper
- 11 USB Memory Slot
- 12 Front Cover Open Button
- 13 Slit Glass
- 14 Original Size Indicator Plates
- 15 Platen
- 16 Operation Panel
- 17 Handles

- 18 Rear Cover
- 19 Handles

 [With Optional Equipments Attached \(page 2-4\)](#)

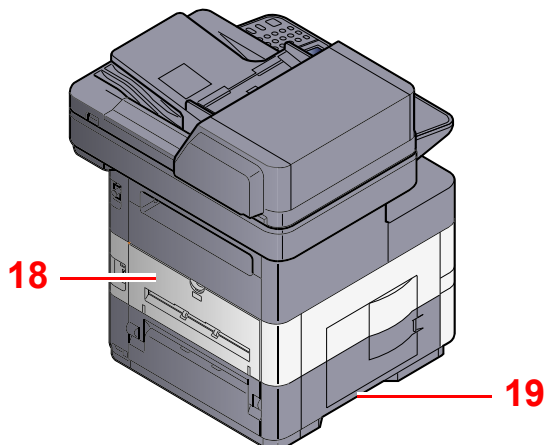

## Connectors/Interior

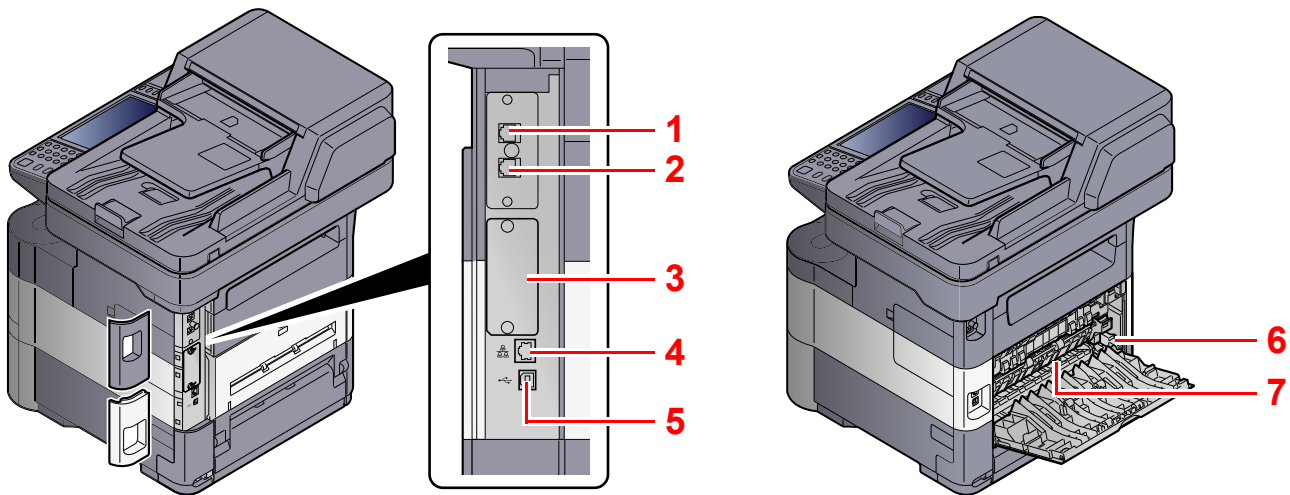

- 1 LINE Connector
- 2 TEL Connector
- 3 Option Interface
- 4 Network Interface Connector

- 5 USB Interface Connector
- 6 Envelope Lever (ECOSYS M3040idn and ECOSYS M3540idn only)
- 7 Fuser Cover

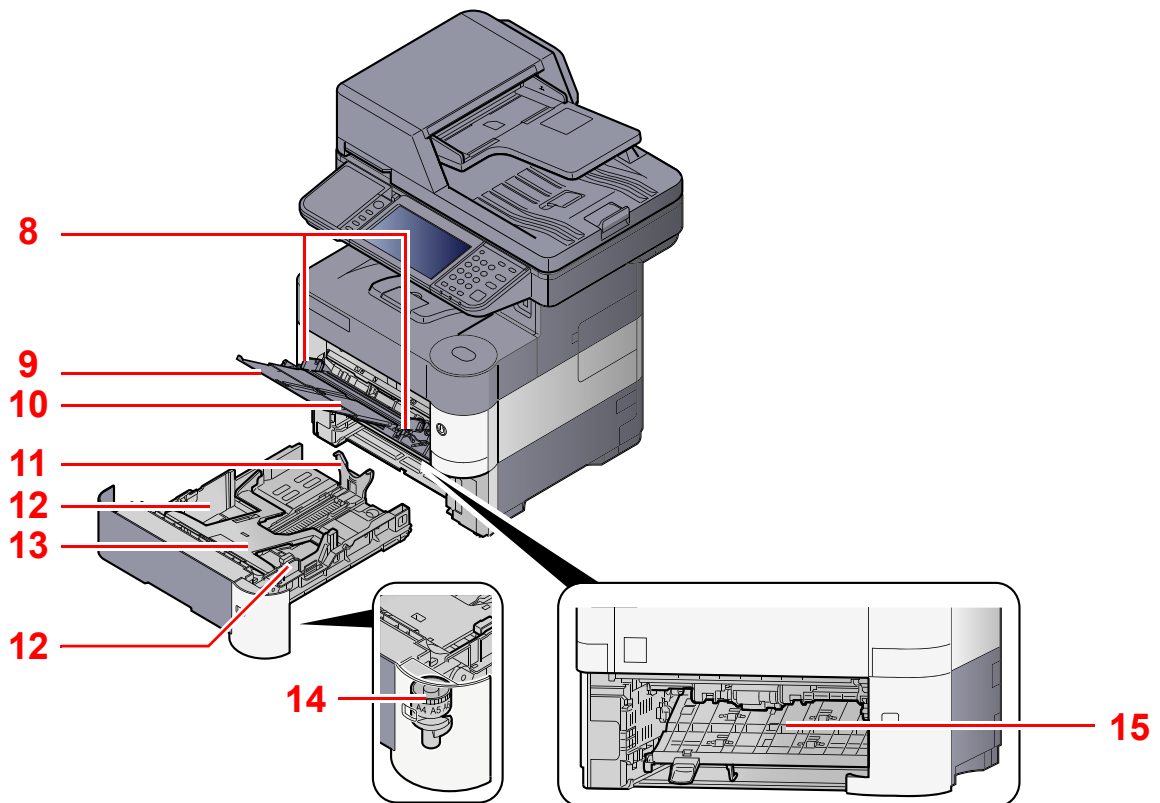

- 8 Paper Width Guides
- 9 Support Tray Section of the Multi Purpose Tray
- 10 Multi Purpose Tray
- 11 Paper Length Guide

- 12 Paper Width Guides
- 13 Bottom Plate (ECOSYS M3040idn and ECOSYS M3540idn only)
- 14 Size Dial
- 15 Duplex Cover



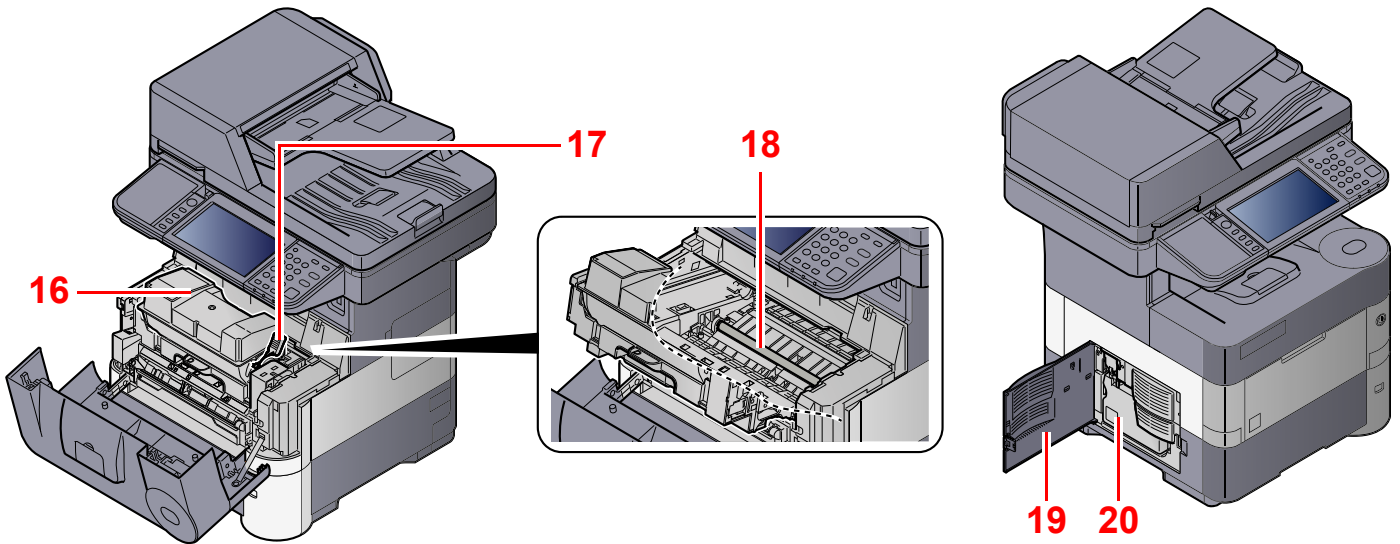

- 16 Toner Container (Black)
- 17 Toner Container Lock Lever
- 18 Registration Roller

- 19 Left Cover
- 20 Waste Toner Box

## With Optional Equipments Attached

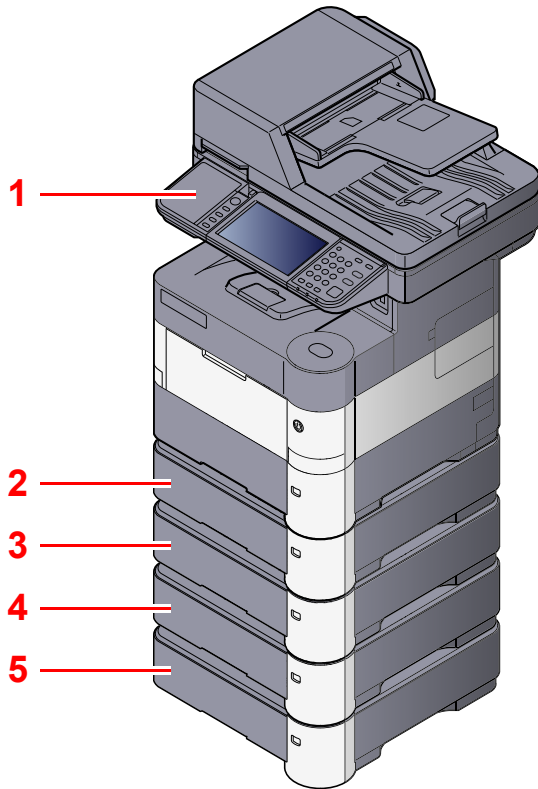

- 1 Card Reader
- 2 Cassette 2
- 3 Cassette 3
- 4 Cassette 4
- 5 Cassette 5

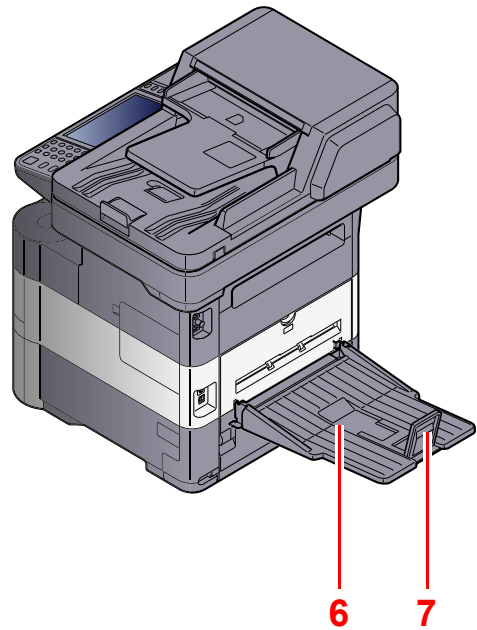

- 6 Rear Tray (ECOSYS M3550idn and ECOSYS M3560idn only)
- 7 Paper Stopper (ECOSYS M3550idn and ECOSYS M3560idn only)



[Optional Equipment \(page 11-2\)](#)



# Connecting the Machine and Other Devices

Prepare the cables necessary to suit the environment and purpose of the machine use.

## When Connecting the Machine to the PC via USB

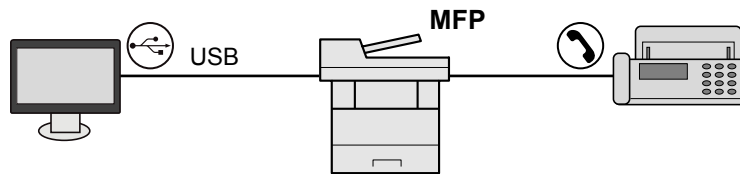

## When Connecting the Machine to the PC on the Network

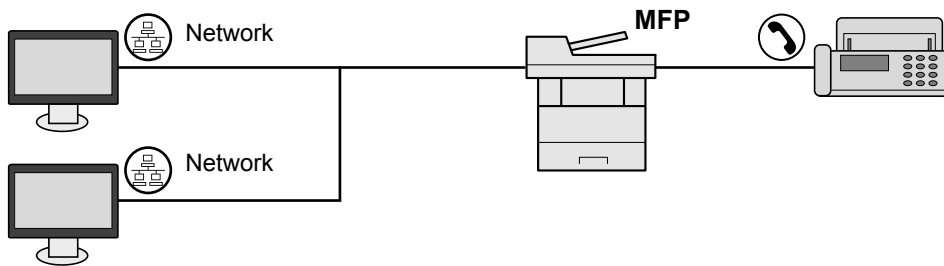

### NOTE

If you are using the machine with the optional wireless interface kit attached, you do not need to connect the LAN cable. To use a wireless LAN, it is necessary to change the default settings for the machine using the System Menu.

 [Optional Network \(page 8-32\)](#)

## Cables that Can Be Used

Connection Environment	Function	Necessary Cable
Connect a LAN cable to the machine.	Printer/Scanner/Network FAX* <sup>1</sup>	LAN cable (10BASE-T, 100BASE-TX, 1000BASE-T)
Connect a USB cable to the machine.	Printer/Scanner (TWAIN/WIA)	USB2.0 compatible cable (Hi-Speed USB compliant, Max. 5.0 m)

\*1 Only on products with the fax function installed.

# Connecting Cables

## Connecting LAN Cable

✔ **IMPORTANT**

If the power is on, turn the power switch off.

🔍 [Power Off \(page 2-8\)](#)

### 1 Connect the cable to the machine.

- 1 Connect the LAN cable to the network interface connector.

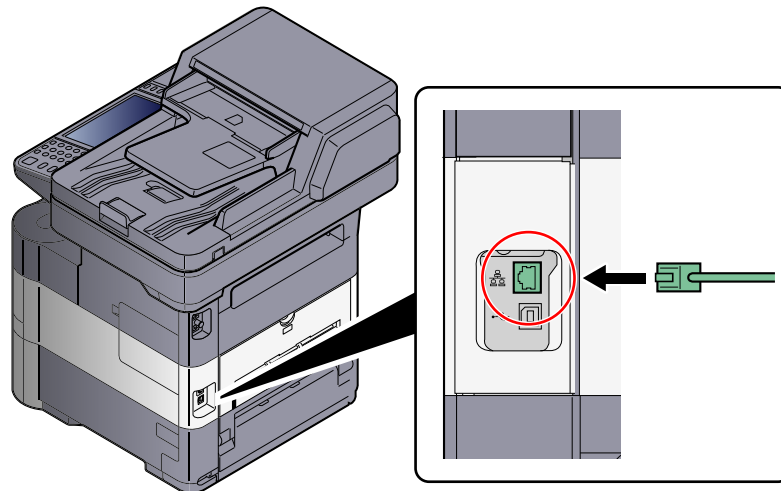

- 2 Connect the other end of the cable to the hub.

### 2 Set up the machine.

Power on the machine and configure the network.

🔍 For details, refer to [Network Setup \(LAN Cable Connection\) on page 2-13](#).

## Connecting USB Cable

✔ **IMPORTANT**

If the power is on, turn the power switch off.

🔍 [Power Off \(page 2-8\)](#)

### 1 Connect the cable to the machine.

- 1 Connect the USB cable to the USB interface connector located on the left side of the body.

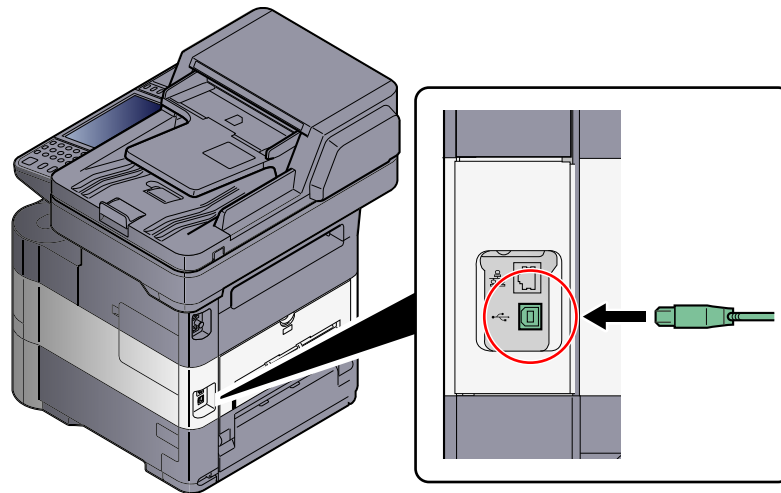

- 2 Connect the other end of the cable to the PC.

## Connecting the Power Cable

### 1 Connect the cable to the machine.

- 1 Remove the cover.

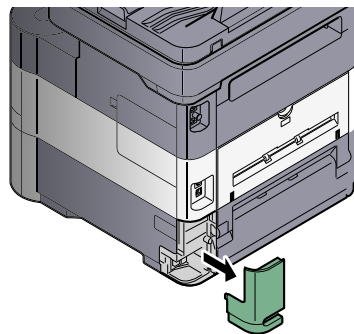

- 2 Connect one end of the supplied power cable to the machine and the other end to a power outlet.

✔ **IMPORTANT**

Only use the power cable that comes with the machine.

# Power On/Off

## Power On

### 1 Turn the power switch on.

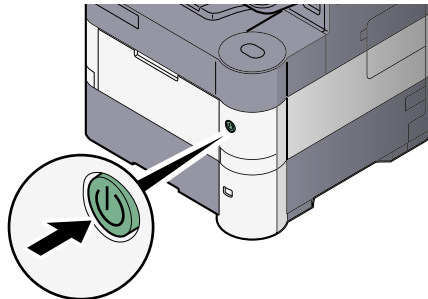

#### ✓ IMPORTANT

When turning off the power switch, do not turn on the power switch again immediately. Wait more than 5 seconds, and then turn on the power switch.

## Power Off

#### ✓ IMPORTANT

When the [Processing] indicator or [Memory] indicator is lit up or blinked, the machine is operating. Turning off the power switch while the machine is operating may cause it to malfunction.

### 1 Turn the power switch off.

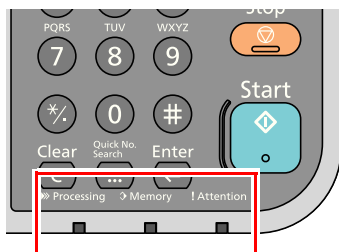

Check that the indicators are off.

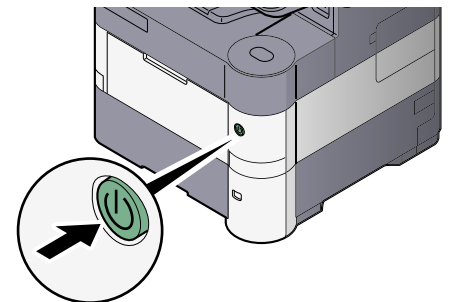

In case of not using the machine for an extended period of time...

#### ⚠ CAUTION

If this machine will be left unused for an extended period (e.g. overnight), turn it off at the main power switch. If the machine will not be used for an even longer period of time (e.g. vacation), remove the power plug from the outlet as a safety precaution. If using the products equipped with the fax function, note that turning the machine off at the main power switch disables fax transmission and reception.

#### ✓ IMPORTANT

Remove paper from the cassettes and seal it in the paper storage bag to protect it from humidity.

# Login/Logout

If you are setting a function that requires administrator rights, or if user login administration is enabled, you must enter your login user name and login password.

## NOTE

The factory default login user name and login password are set as shown below.

Model Name	Login User Name	Login Password
ECOSYS M3040idn/ECOSYS M3540idn	4000	4000
ECOSYS M3550idn	5000	5000
ECOSYS M3560idn	6000	6000

You will be unable to login if you forget your login user name or login password. In this event, login with administrator privileges and change your login user name or login password.

## Login

### Normal login

#### 1 Enter the login user name and login password to login.

- 1 If this screen is displayed during operations, press [Keyboard] to enter the login user name.

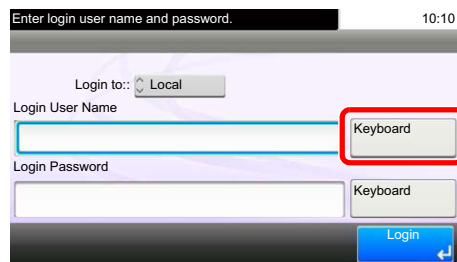

The screenshot shows a login interface with the title 'Enter login user name and password.' and a time display of '10:10'. Below the title, there is a 'Login to:' dropdown menu set to 'Local'. The 'Login User Name' field has a 'Keyboard' button next to it, which is highlighted with a red box. The 'Login Password' field also has a 'Keyboard' button next to it. At the bottom right, there is a blue 'Login' button with a right arrow.

 [Character Entry Method \(page 11-12\)](#)

- 2 Press [Password] to enter the login password and press [OK].

## NOTE

If [Network Authentication] is selected as the user authentication method, either [Local] or [Network] can be selected as the authentication destination.

#### 2 Press [Login].

## Simple Login

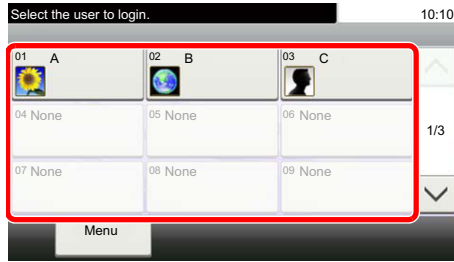

If this screen is displayed during operations, select a user and log in.



### NOTE

If a user password is required, an input screen will be displayed.



[Simple Login Settings \(page 9-25\)](#)

## Logout



To logout from the machine, press the **[Authentication/Logout]** key to return to the login user name/login password entry screen.

Users are automatically logged out in the following circumstances:

- When the machine enters the low power or sleep state.
- When the auto panel reset function is activated.

# Default Settings of the Machine

Before using this machine, configure such settings as date and time, network configuration, and energy saving functions as needed. The Machine Setup Wizard is launched when the equipment is turned on for the first time after being installed. Also, configure the following settings if necessary.



**NOTE**

The default settings of the machine can be changed in System Menu. For settings that are configurable from System Menu, refer to [Setup and Registration \(System Menu\) \(page 8-1\)](#).

## Setting Date and Time

Follow the steps below to set the local date and time at the place of installation.

When you send an E-mail using the transmission function, the date and time as set here will be printed in the header of the E-mail message. Set the date, time and time difference from GMT of the region where the machine is used.



**NOTE**

To make changes after this initial configuration, refer to [Date/Timer/Energy Saver on page 8-37](#) and [System/Network on page 8-27](#).

### 1 Display the screen.

Press the [**System Menu/Counter**] key, [∨], and then [Date/Timer/Energy Saver].

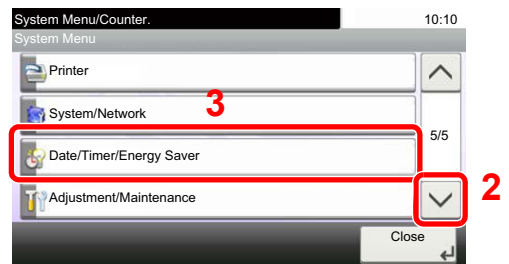

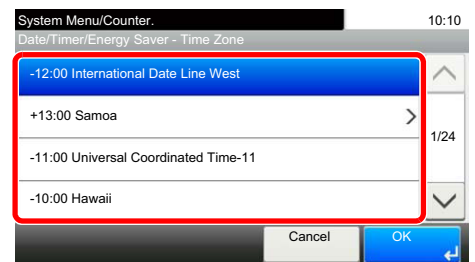
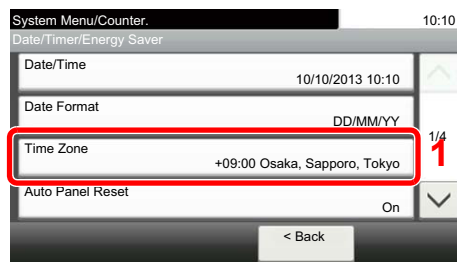

### 2 Configure the settings.

#### 1 Set the time zone.

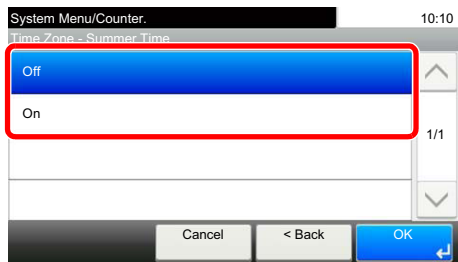

2 Set the summer time.



 **NOTE**

If you select a region that does not utilize summer time, the summer time setting screen will not appear.

3 Set the date.

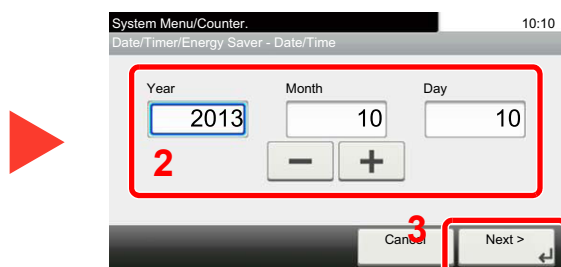

4 Set the time.

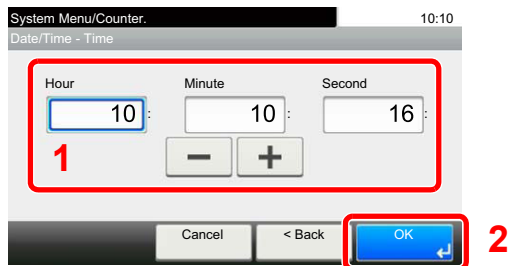



## Network Setup (LAN Cable Connection)

The machine is equipped with network interface, which is compatible with network protocols such as TCP/IP (IPv4), TCP/IP (IPv6), NetBEUI, and IPsec. It enables network printing on the Windows, Macintosh, UNIX and other platforms.

Set up TCP/IP (IPv4) to connect to the Windows network. For setting procedure, refer to the [Quick Setup Wizard on page 2-17](#).

### NOTE

- Ask your network administrator for the IP address in advance, and have it ready when you configure this setting. In the following cases, set the IP address of DNS server on the Command Center RX.
  - When using the host name with "DHCP" setting set to "Off"
  - When using the DNS server with IP address that is not assigned by DHCP automatically.

Refer to the **Command Center RX User Guide**.

- For other network settings, refer to the [Network on page 8-27](#).

## Wireless Network Settings

When the optional Wireless Network Interface Kit (IB-51) is installed on the machine and the connection settings are configured, it is possible to print in a wireless network (wireless LAN) environment. The following is an introduction to the settings for connecting using the Quick Setup.

The following four settings can be configured in Quick Setup. Set the Wireless Network by referring to [Wireless Network on page 8-33](#).

### Available Network

Displays access points to which the machine can connect.

### Push Button

If the access point supports the push button method, wireless settings can be configured using the push button. This setting executes push button, and the connection is started by pressing the push button on the access point.

### NOTE

The push button method supports only the WPS (WiFi Protected Setup).

### PIN (Device)

Starts connection using the machine's PIN code. Enter the PIN code into the access point. The PIN code of the machine is automatically generated.

### PIN (Terminal)

Starts connection using the PIN code of the access point. Enter the PIN code of the access point.

# Energy Saver function

If a certain period of time elapses after the machine is last used, the machine automatically enters Low Power Mode to reduce power consumption. If a further period of time elapses without the machine being used, the machine automatically enters sleep mode, which minimizes power consumption. If the machine is not used while in sleep mode, the power automatically turns off.

## Low Power Mode and Auto Low Power Mode

### Low Power Mode

If the machine is not operated for a certain period of time, the energy saver indicator will light up and the screen will become dark to reduce power consumption. This status is referred to as Low Power Mode. "Low power." will be displayed on the screen.

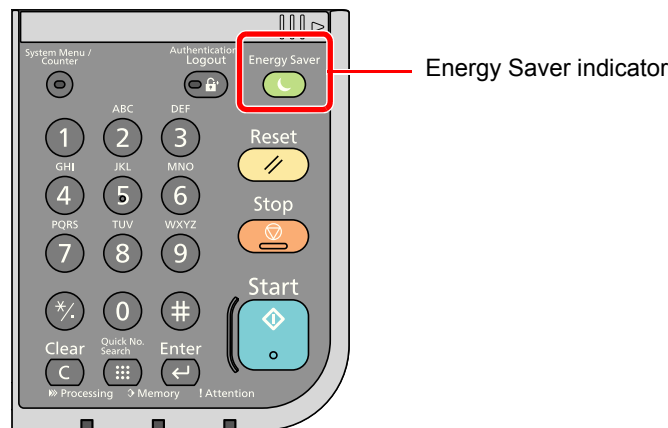

If print data is received during Low Power Mode, the machine automatically wakes up and starts printing. Also when fax data arrives while the machine is in Low Power Mode, the machine automatically wakes up and starts printing.

To resume, perform one of the following actions.

- Press the touch panel or any key on the operation panel.
- Open the document processor.
- Place originals in the document processor.

The machine will be ready to operate within 10 seconds.

Note that ambient environmental conditions, such as ventilation, may cause the machine to respond more slowly.

### Auto Low Power Mode

Auto Low Power Mode automatically switches the machine into Low Power Mode if left idle for a preset time.

The default preset time is 1 minute.

For information on the Low Power Mode settings, refer to [Quick Setup Wizard on page 2-17](#).

#### NOTE

If the Low Power Timer is equal to the Sleep Timer, a Sleep mode is preceded.

## Sleep and Auto Sleep

### Sleep

To enter Sleep, press the **[Energy Saver]** key. Touch panel and all indicators on the operation panel will go out to save a maximum amount of power except the Energy Saver indicator. This status is referred to as Sleep.

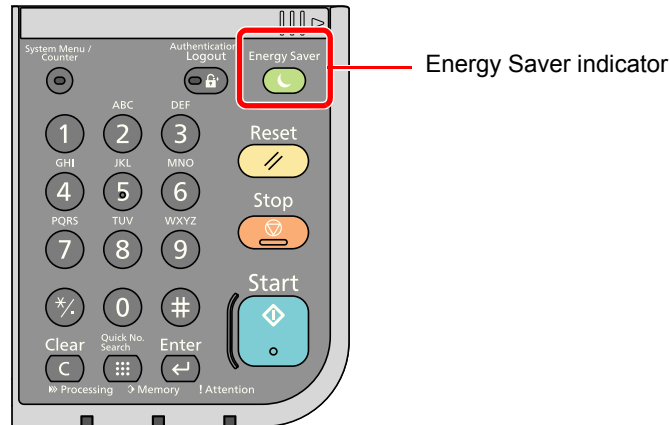

If print data is received during Sleep, the machine automatically wakes up and starts printing.

Also when fax data arrives while the machine is in Sleep, the machine automatically wakes up and starts printing.

To resume, perform the following actions.

- Press the **[Energy Saver]** key.

The machine will be ready to operate within 15 seconds (ECOSYS M3040idn/ECOSYS M3540idn), 20 seconds (ECOSYS M3550idn) or 25 seconds (ECOSYS M3560idn).

Note that ambient environmental conditions, such as ventilation, may cause the machine to respond more slowly.

### Auto Sleep

Auto Sleep automatically switches the machine into Sleep if left idle for a preset time in the Low Power Mode.

The default preset time is 1 minute.

To change the preset sleep time, refer to [Quick Setup Wizard on page 2-17](#).



#### NOTE

If the Low Power Timer is equal to the Sleep Timer, a Sleep mode is preceded.

### Sleep Rules (models for Europe)

You can set whether sleep mode operates for each function. When the machine enters sleep mode, the ID card cannot be recognized.



For more information on Sleep Rules settings, refer to [Sleep Rules \(models for Europe\) on page 8-38](#).

## Sleep Level (Energy Saver and Quick Recovery) (models except for Europe)

For sleep level, you can toggle between the following two modes: Energy Saver mode and Quick Recovery mode. The default setting is Energy Saver mode.

Energy Saver mode reduces power consumption even more than Quick Recovery mode, and allows Sleep Mode to be set separately for each function. The time required for the machine to wake up from power save mode and resume normal operation will be longer than for Quick Recovery mode. The ID card cannot be recognized.



### NOTE

If the optional Network Interface Kit is installed, Energy Saver cannot be specified.

Quick Recovery mode recovers from sleep mode quicker than Energy Saver mode. To resume, press the [**Energy Saver**] key on the operation panel. If print data is received during Sleep, the machine automatically wakes up and starts printing.



For more information on Sleep Level settings, refer to [Quick Setup Wizard on page 2-17](#).

# Quick Setup Wizard

For FAX functions, paper settings, Energy Saver functions and network settings, the following settings can be configured in a wizard-style screen.

<b>FAX Setup</b>	Configures basic fax settings.	
	1. Dialing/RX Mode	Dialing Mode Reception Mode Auto (DRD)
	2. Local FAX Info.	Local FAX Name Local FAX Number Local FAX ID TTI
	3. Sound	Speaker Volume Monitor Volume Job Finish Buzzer
	4. Rings	Normal Answering Machine FAX/TEL Switch
	5. Redial	Retry Times
<b>Paper Setup</b>	Configures the paper size and media type of paper to be used in cassettes and multi purpose tray.	
	1. Cassette 1	Paper Size <sup>*1</sup> Media Type
	2. Cassette 2 <sup>*2</sup>	Paper Size <sup>*1</sup> Media Type
	3. Cassette 3 <sup>*2</sup>	Paper Size <sup>*1</sup> Media Type
	4. Cassette 4 <sup>*2</sup>	Paper Size <sup>*1</sup> Media Type
	5. Cassette 5 <sup>*2</sup>	Paper Size <sup>*1</sup> Media Type
	6. MP Tray	Paper Size Media Type
<b>Energy Saver Setup</b>	Configures sleep mode and low-power mode.	
	1. Sleep Mode	Sleep Timer Sleep Level (models except for Europe)
	2. Low Power Mode	Low Power Timer
<b>Network Setup</b>	Configures network settings.	
	1. Network	Obtain IP Address IP Address <sup>*3</sup> Subnet Mask <sup>*3</sup> Default Gateway <sup>*3</sup>

\*1 Displayed only when the size dial on the cassette is set to "Other".

\*2 Displayed only when the optional paper feeder is installed.

\*3 Not displayed when "Obtain IP Address" is set to [Auto (DHCP)].

**NOTE**

If the user authentication screen appears, enter your login user name and login password and press [Login]. The factory default login user name and login password are set as shown below.

Model Name	Login User Name	Login Password
ECOSYS M3040idn/ECOSYS M3540idn	4000	4000
ECOSYS M3550idn	5000	5000
ECOSYS M3560idn	6000	6000

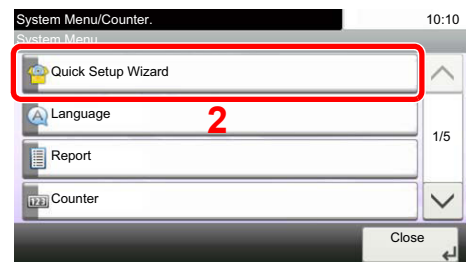
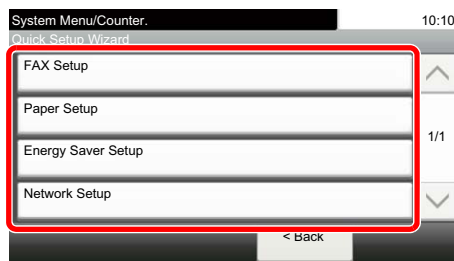
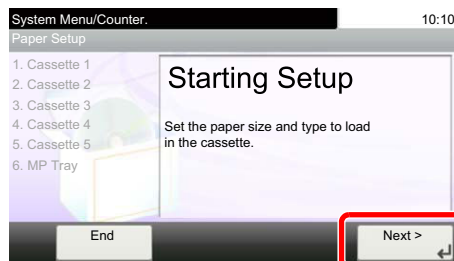
**1 Display the screen.****2 Select a function.****3 Configure the settings.**

Start the wizard. Follow the instructions on the screen to configure settings.

**NOTE**

If you experience difficulty configuring the settings, refer to [Help Screen on page 3-11](#).

Control	Description
End	Exits the wizard. Settings configured so far are applied.
Previous	Returns to the previous item.
Skip	Advances to the next item without setting the current item.
Next	Advances to the next screen.
Back	Returns to the previous screen.
Complete	Register the settings and exit the wizard.

# Installing Software

Install appropriate software on your PC from the included DVD (Product Library) if you want to use the printer function of this machine or perform TWAIN / WIA transmission or Network FAX transmission from your PC.

## Software on DVD (Windows)

You can use either [[Express Install](#)] or [[Custom Install](#)] can be selected for the installation method. [[Express Install](#)] is the standard installation method. To install components that cannot be installed by [[Express Install](#)], use [[Custom Install](#)]. For details on Custom Installation, refer to [Custom Install on page 2-23](#).

Software	Description	Express Install
KX DRIVER	This driver enables files on a computer to be printed by the machine. Multiple page description languages (PCL XL, KPD, etc.) are supported by a single driver. This printer driver allows you to take full advantage of the features of the machine. Use this driver to create PDF files.	<input type="radio"/>
KX XPS DRIVER	This printer driver supports the XPS (XML Paper Specification) format developed by Microsoft Corporation.	-
KPDL mini-driver/PCL mini-driver	This is a Microsoft MiniDriver that supports PCL and KPDL. There are some restrictions on the machine features and option features that can be used with this driver.	-
FAX Driver	This makes it possible to send a document created in a computer software application as a fax via the machine.	-
Kyocera TWAIN Driver	This driver enables scanning on the machine using a TWAIN-compliant software application.	<input type="radio"/>
Kyocera WIA Driver	WIA (Windows Imaging Acquisition) is a function of Windows that enables reciprocal communication between an imaging device such as a scanner and an image processing software application. An image can be acquired using a WIA-compliant software application, which is convenient when a TWAIN-compliant software application is not installed in the computer.	-
KYOCERA Net Viewer	This is a utility that enables monitoring of the machine on the network.	-
Status Monitor	This is a utility that monitors the printer status and provides an ongoing reporting function.	<input type="radio"/>
File Management Utility	This makes it possible to send and save a scanned document to a specified network folder.	-
KYOCERA Net Direct Print	This makes it possible to print a PDF file without starting Adobe Acrobat/Reader.	-
FONTS	These are display fonts that enable the machine's built-in fonts to be used in a software application.	<input type="radio"/>



### NOTE

- Installation on Windows must be done by a user logged on with administrator privileges.
- When connected by USB cable, Plug and Play is disabled on this device when in Sleep mode. To continue the installation, press the [[Energy Saver](#)] key to wake the device from Sleep before continuing.
- Fax functionality can only be used on products equipped with fax capability.
- WIA driver and KX XPS DRIVER cannot be installed on Windows XP.



# Installing Software in Windows

## Express Install

The following procedure is an example for installing the software in Windows 7 using [\[Express Install\]](#).

For details on Custom Installation, refer to [Custom Install on page 2-23](#).

### 1 Insert the DVD.

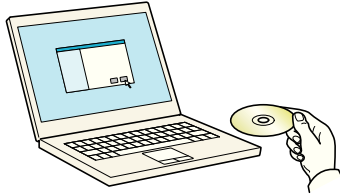

#### NOTE

- Installation on Windows must be done by a user logged on with administrator privileges.
- If the "[Welcome to the Found New Hardware Wizard](#)" dialog box displays, select [\[Cancel\]](#).
- If the autorun screen is displayed, click [\[Run setup.exe\]](#).
- If the user account management window appears, click [\[Yes\]](#) ([\[Allow\]](#)).

### 2 Display the screen.

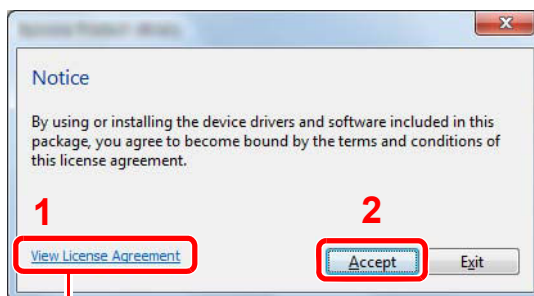

Click [\[View License Agreement\]](#) and read the License Agreement.

### 3 Install using [\[Express Install\]](#).

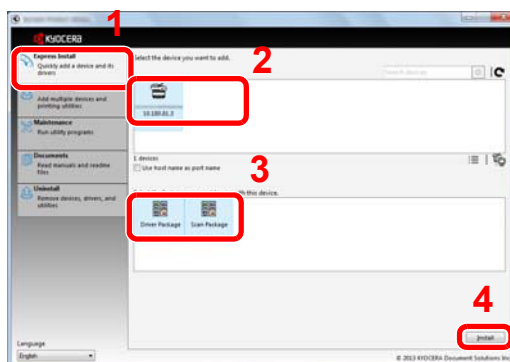

You can also select [\[Use host name for port name\]](#) and set to use the host name of the standard TCP/IP port. (A USB connection cannot be used.)



**NOTE**

- The machine cannot be detected unless it is on. If the computer fails to detect the machine, verify that it is connected to the computer via a network or USB cable and that it is turned on and click (Reload).
- If the Windows security window appears, click [[Install this driver software anyway](#)].

## 4 Finish the installation.

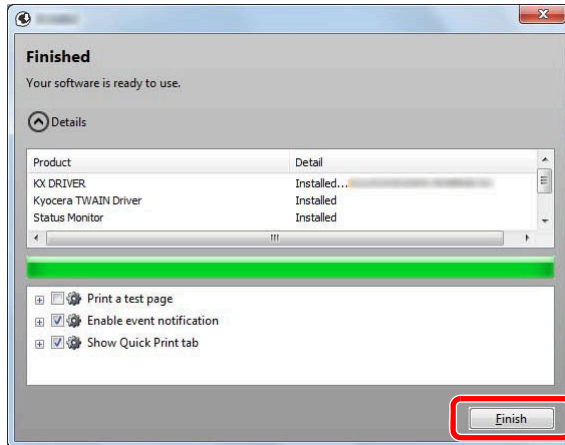

When "[Your software is ready to use](#)" appears, you can use the software. To print a test page, click the "[Print a test page](#)" checkbox and select the machine.

Click [[Finish](#)] to exit the wizard.



**NOTE**

When you have selected [[Device settings](#)] in Windows XP, the dialog box for device setting will appear after [[Finish](#)] is clicked. Configure the settings for options installed on the machine. Device settings can be configured after the installation is completed. For details, refer to the Device Settings in the **Printer Driver User Guide** on the DVD.

If a system restart message appears, restart the computer by following the screen prompts. This completes the printer driver installation procedure.

If you are installing the TWAIN driver, continue by configuring the [Setting TWAIN Driver \(page 2-29\)](#).

## Custom Install

The following procedure is an example for installing the software in Windows 7 using [\[Custom Install\]](#).

### 1 Insert the DVD.

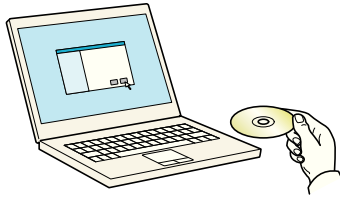

#### NOTE

- Installation on Windows must be done by a user logged on with administrator privileges.
- If the "[Welcome to the Found New Hardware Wizard](#)" dialog box displays, select [\[Cancel\]](#).
- If the autorun screen is displayed, click [\[Run setup.exe\]](#).
- If the user account management window appears, click [\[Yes\]](#) ([\[Allow\]](#)).

### 2 Display the screen.

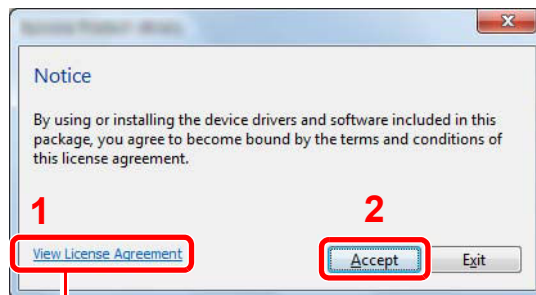

Click [\[View License Agreement\]](#) and read the License Agreement.

### 3 Install using [Custom Install].

- 1 Select the device to be installed.

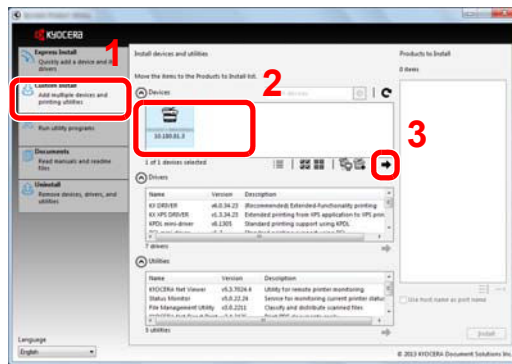

The following buttons can be used.

 : This changes the display to icon and text display.

 : Use this to select multiple items.

 : If the desired device does not appear, press this button to directly select the device.

- 2 Select the driver to be installed.

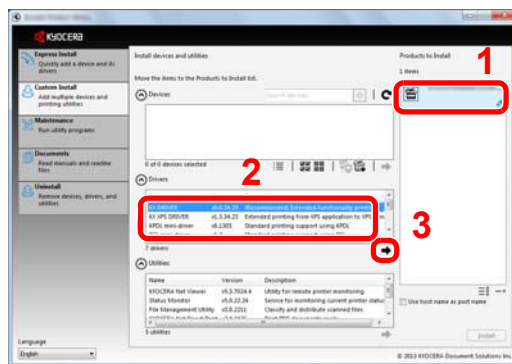

- 3 Select the utility to be installed.

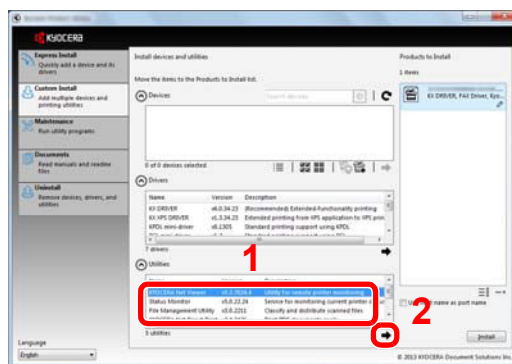

4 Click [Install].

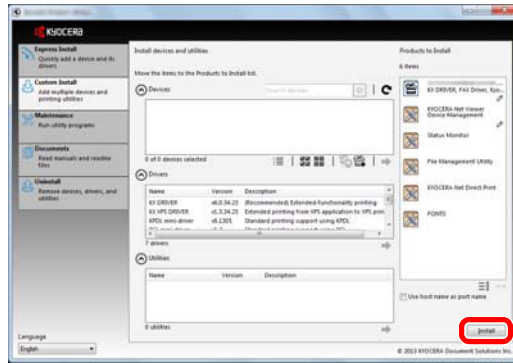

4 Finish the installation.

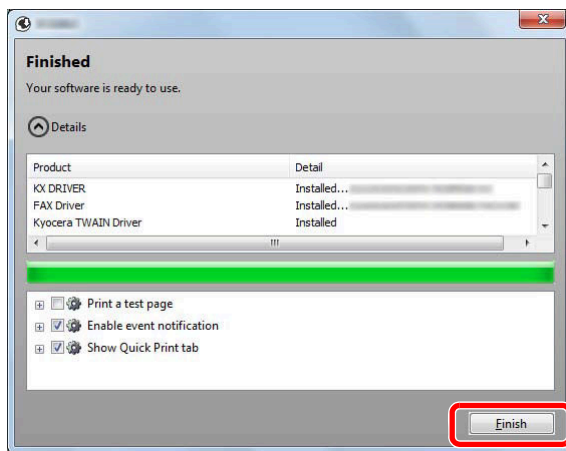

When "**Your software is ready to use**" appears, you can use the software. To print a test page, click the "**Print a test page**" checkbox and select the machine.

Click [**Finish**] to exit the wizard.



**NOTE**

When you have selected [**Device settings**] in Windows XP, the dialog box for device setting will appear after [**Finish**] is clicked. Configure the settings for options installed on the machine. Device settings can be configured after the installation is completed. For details, refer to the Device Settings in the **Printer Driver User Guide** on the DVD.

If a system restart message appears, restart the computer by following the screen prompts. This completes the printer driver installation procedure.

If you are installing the TWAIN driver, continue by configuring the [Setting TWAIN Driver \(page 2-29\)](#).

## Uninstalling the Software

Perform the following procedure to delete the Software from your computer.



### NOTE

Uninstallation on Windows must be done by a user logged on with administrator privileges.

### 1 Display the screen.

Click **[Start]** button on the Windows and then select **[All Programs]**, **[Kyocera]**, and **[Uninstall Kyocera Product Library]** to display the Uninstall Wizard.



### NOTE

In Windows 8, click **[Search]** in charms, and enter "Uninstall Kyocera Product Library" in the search box. Select **[Uninstall Kyocera Product Library]** in the search list.

### 2 Uninstall the software.

Place a check in the check box of the software to be deleted.

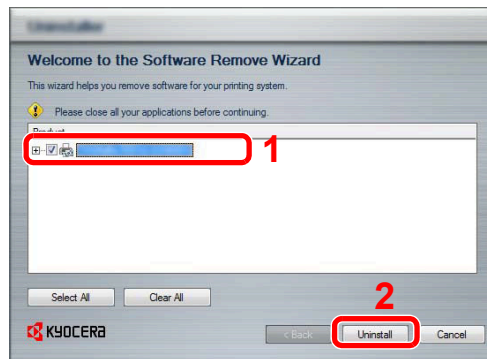

### 3 Finish uninstalling.

If a system restart message appears, restart the computer by following the screen prompts. This completes the software uninstallation procedure.



### NOTE

- The software can also be uninstalled using the Product Library.
- In the Product Library screen, click **[Uninstall]**, and follow the on-screen instructions to uninstall the software.

# Installing Software in Mac Computer

The machine's printer functionality can be used by a Mac computer.

## NOTE

- Installation on MAC OS must be done by a user logged on with administrator privileges.
- When printing from a Macintosh computer, set the machine's emulation to [KPD] or [KPD(Auto)].

 For details, refer to [Printer on page 8-25](#).

- If connecting by Bonjour, enable Bonjour in the machine's network settings.

 For details, refer to [Bonjour on page 8-28](#).

- In the Authenticate screen, enter the name and password used to log in to the operating system.

## 1 Insert the DVD.

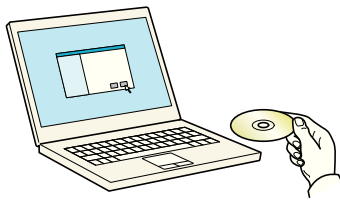

Double-click the [Kyocera] icon.

## 2 Display the screen.

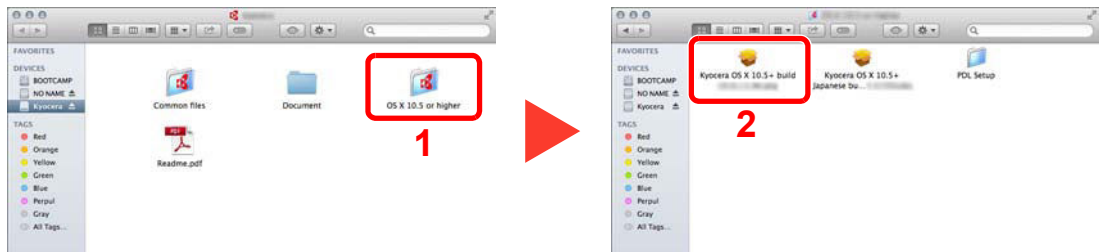

Double-click [Kyocera OS X x.x] depending on your Mac OS version.

## 3 Install the Printer Driver.



Install the printer driver as directed by the instructions in the installation software.

This completes the printer driver installation.

If a USB connection is used, the machine is automatically recognized and connected.  
If an IP connection is used, the settings below are required.

## 4 Configure the printer.

1 Display the window.



2 Select [Default] and click the item that appears in "Name".

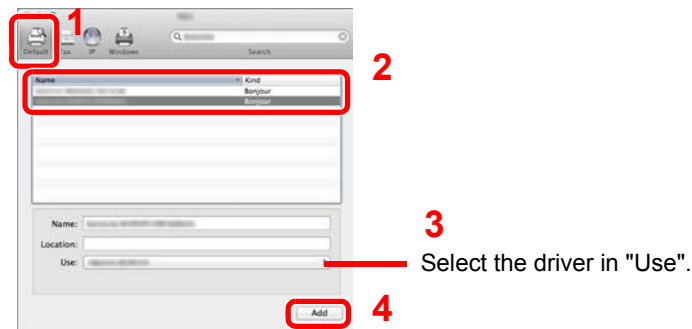

### NOTE

When using an IP connection, click the IP icon for an IP connection and then enter the IP address and printer name. The number entered in "Address" will automatically appear in "Name". Change if needed.

3 Select the options available for the machine.

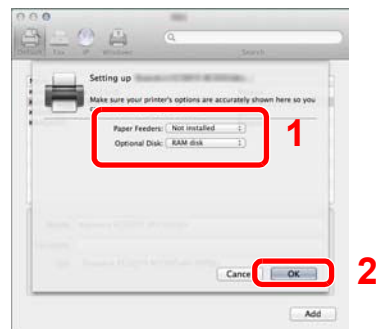

4 The selected machine is added.

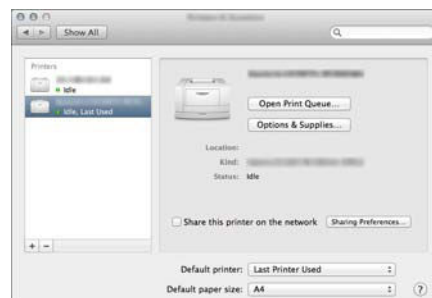



# Setting TWAIN Driver

Register this machine to the TWAIN Driver. Instructions are based on interface elements as they appear in Windows 7.

## 1 Display the screen.

- 1 Select [Start] button on the Windows, [All Programs], [Kyocera] and then [TWAIN Driver Setting]. TWAIN Driver screen appears.







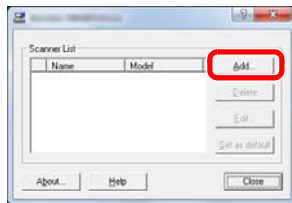

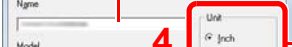
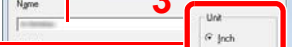

 **NOTE**

In Windows 8, click [Search] in charms, and enter "TWAIN Driver Setting" in the search box. Select [TWAIN Driver Setting] in the search list.

- 2 Click [Add].

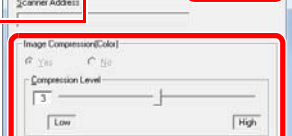

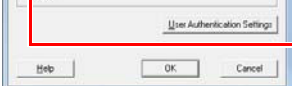
## 2 Configure TWAIN Driver.

	(Network)		(USB)
1		Enter the machine name.	
2		Set units of measurement.	
3		Select this machine from the list.	
		Enter the machine's IP address or host name.	
		Set the Compression Level.	
5		When using SSL, select the checkbox beside SSL.	

 **NOTE**

When the machine's IP address or host name is unknown, contact Administrator.

## 3 Finish registering.

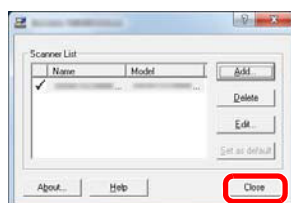

 **NOTE**

Click [Delete] to delete the added machine. Click [Edit] to change names.

## Setting WIA Driver

Register this machine to the WIA Driver. Instructions are based on interface elements as they appear in Windows 7.

### 1 Display the screen.

- 1 Click [Start] button on the Windows and enter [Scanner] in [Program and File Search]. Click [View scanners and cameras] in the search list then the Scanners and Cameras screen appears.

#### NOTE

In Windows 8, click [Search] in charms, and enter "View scanners and cameras" in the search box. Select [View scanners and cameras] in the search list then the Scanners and Cameras screen appears.

- 2 Select the same name as this machine from WIA Drivers, and press [Properties].

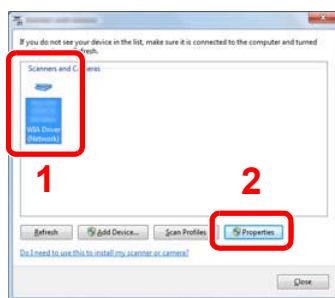

### 2 Configure WIA Driver.

(Network)

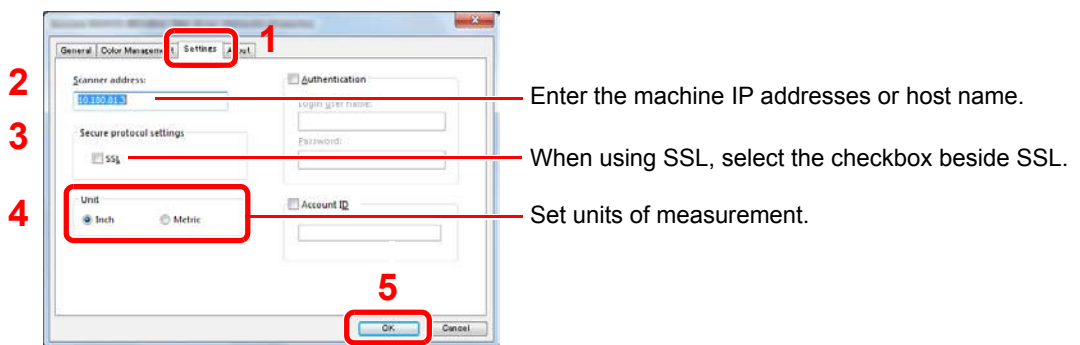

(USB)

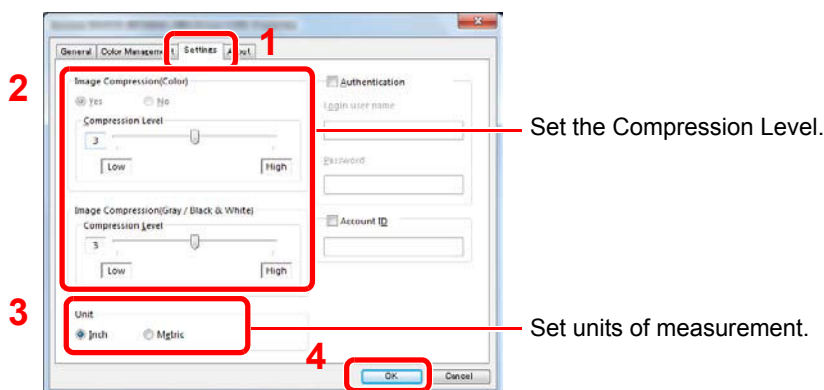

# Checking the Counter

Press the [System Menu/Counter] key to check the number of sheets printed and scanned.

## 1 Display the screen.



## 2 Check the counter.

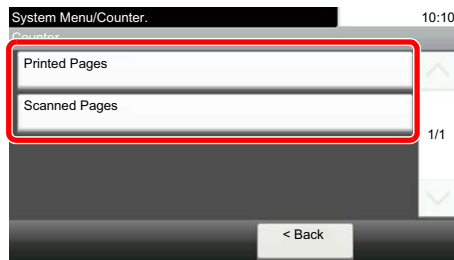

Pressing [∨] and then [by Duplex] allows you to check the number of pages used in Duplex (1-sided) mode, Duplex (2-sided) mode and the total for both.

Pressing [∨] and then [by Combine] allows you to check the number of pages used in Combine (None) mode, Combine (2 in 1) mode, Combine (4 in 1) mode and the total for all three.

Pressing [∨] and then [by Paper Size] allows you to check the number of pages printed in each paper size.

# Additional Preparations for the Administrator

In addition to the information provided in this chapter, the administrator of this machine should check the following, and configure the settings as needed.

## Sending Documents to a PC

### To Send to a Shared Folder (Send to Folder (SMB))

To send a document that has been loaded, you need to create a shared folder to receive the document on your computer. For details, refer to [Preparation for Sending a Document to a Shared Folder in a PC on page 3-25](#).

### To E-mail Scanned Images (Send as E-mail)

You can send a scanned original image as an E-mail attachment. For registration method, refer to [E-mail Settings on page 2-41](#).

## Strengthening the Security

This machine is shipped with two default users registered one with Machine Administrator rights, and another with Administrator rights. Logging in as this user will allow you to configure all settings; therefore, please change the login user name and password.

In addition, this machine is equipped with user authentication function, which can be configured to limit the access to this machine to only those who have a registered login name and password. For each setting procedure, refer to [User Authentication and Accounting \(User Login, Job Accounting\) \(page 9-1\)](#).

I want to...	Function	Reference page
<b>Restrict the users of the machine.</b>	User Login	<a href="#">page 9-2</a>
	Auto Panel Reset	<a href="#">page 8-37</a>
	ID Card Settings <sup>*1</sup>	<a href="#">page 9-29</a>
<b>Restrict the basic functions that can be used.</b>	Local Authorization	<a href="#">page 9-19</a>
	Group Authorization Set.	<a href="#">page 9-20</a>
<b>Prevent another user from handling the documents stored in the machine.</b>	Custom Box <sup>*2</sup>	<a href="#">page 5-43</a>
<b>Prevent the data stored in the machine from being leaked.</b>	Data Overwrite <sup>*3</sup>	Refer to the <b>Data Security Kit (E) Operation Guide</b> .
	Encryption <sup>*3</sup>	
	PDF Encryption Functions	<a href="#">page 6-25</a>
<b>Completely delete the data on the machine before disposing of the machine.</b>	Data Sanitization	<a href="#">page 8-36</a>

\*1 The optional Card Authentication Kit is required.

\*2 The optional SSD is required.

\*3 The optional Data Security Kit is required.

I want to...	Function	Reference page
<b>Protect the transmission from interception and wiretapping.</b>	IPP over SSL	<a href="#">page 8-29</a>
	HTTPS	<a href="#">page 8-29</a>
	LDAP Security	<a href="#">page 8-31</a>
	SMTP Security	<a href="#">page 8-31</a>
	POP3 Security	<a href="#">page 8-31</a>
	FTP Encrypted TX	<a href="#">page 6-28</a>
	Enhanced WSD (SSL)	<a href="#">page 8-30</a>
	IPSec	<a href="#">page 8-31</a>
	SNMPv3	<a href="#">page 8-29</a>

# Command Center RX

If the machine is connected to the network, you can configure various settings using Command Center RX.

This section explains how to access Command Center RX, and how to change security settings and the host name. For details on Command Center RX, refer to the **Command Center RX User Guide**.

## NOTE

To fully access the features of the Command Center RX pages, enter the User Name and Password and click [[Login](#)]. Entering the predefined administrator password allows the user to access all pages, including Document Box, Address Book, and Settings on the navigation menu. The factory default setting for the default user with administrator privileges is shown below.

<b>Login User Name</b>	<b>Admin</b>
<b>Login Password</b>	<b>Admin</b>

\* Upper case and lower case letters are distinguished (case sensitive).

Settings that the administrator and general users can configure in Command Center RX are as follows.

Setting	Description	Administ-rator	General User
<b>Device Information</b>	The machine's structure can be checked.	<input type="radio"/>	<input type="radio"/>
<b>Job Status</b>	Displays all device information, including print and scan jobs, storing jobs, scheduled jobs, and job log history.	<input type="radio"/>	<input type="radio"/>
<b>Document Box</b>	Add or delete document boxes, or delete documents within a document box.	<input type="radio"/>	<input type="radio"/> *1
<b>Address Book</b>	Create, edit, or delete addresses and address groups.	<input type="radio"/>	<input type="radio"/> *1
<b>Device Settings</b>	Configure the advanced settings of the machine.	<input type="radio"/>	-
<b>Function Settings</b>	Configure the advanced function settings.	<input type="radio"/>	-
<b>Network Settings</b>	Configure the network advanced settings.	<input type="radio"/>	-
<b>Security Settings</b>	Configure the security advanced settings.	<input type="radio"/>	-
<b>Management Settings</b>	Configure the advanced management settings.	<input type="radio"/>	-

\*1 The logged in user may not be able to configure some settings, depending on the permissions of the user.

## NOTE

- FAX functions are available only on products with the fax function installed.
- Here, information on the FAX settings has been omitted. For more information on using the FAX, refer to the **FAX Operation Guide**.

## Accessing Command Center RX

### 1 Display the screen.

- 1 Launch your Web browser.
- 2 In the address or location bar, enter the machine's IP address or the host name.  
Press [Device Information] in the home screen and then [Identification/Network] to check the machine's IP address and the host name.

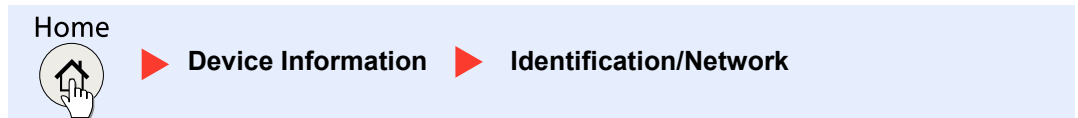

Examples: <https://192.168.48.21/> (for IP address)  
<https://MFP001> (if the host name is "MFP001")

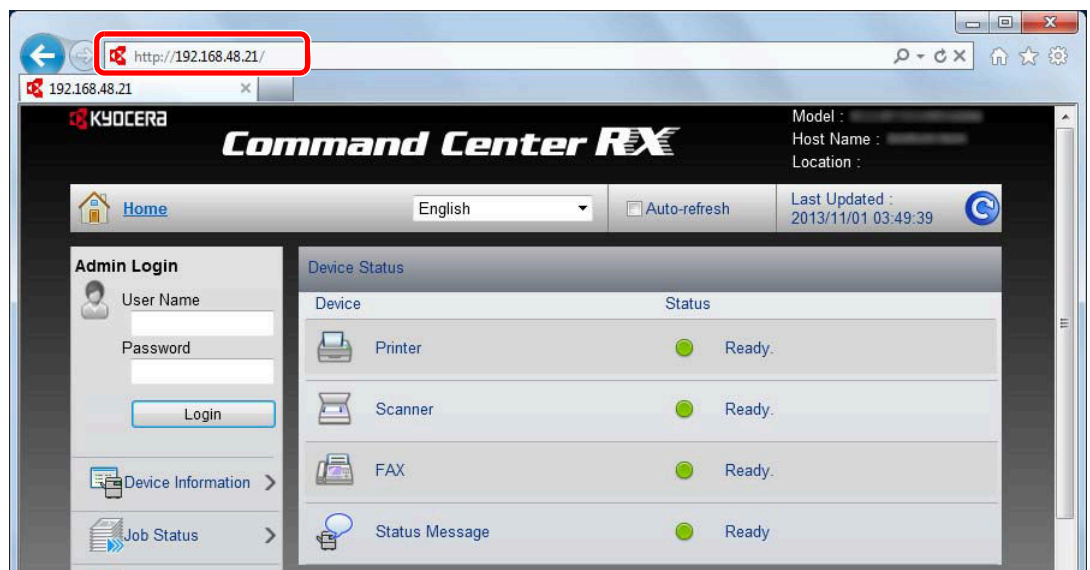

The web page displays basic information about the machine and Command Center RX as well as their current status.



#### NOTE

- If the screen "There is a problem with this website's security certificate." is displayed, configure the certificate. For details on Certificates, refer to the **Command Center RX User Guide**.
- You can also continue the operation without configuring the certificate.

## 2 Configure the function.

Select a category from the navigation bar on the left of the screen.



### NOTE

To fully access the features of the Command Center RX pages, enter the User Name and Password and click [[Login](#)]. Entering the predefined administrator password allows the user to access all pages, including Document Box, Address Book, and Settings on the navigation menu. The factory default setting for the default user with administrator privileges is shown below.

<b>Login User Name</b>	<b>Admin</b>
<b>Login Password</b>	<b>Admin</b>

\* Upper case and lower case letters are distinguished (case sensitive).



## Changing Security Settings

This section explains how to change the security settings.

### 1 Display the screen.

1 Launch your Web browser.

2 In the address or location bar, enter the machine's IP address or the host name.

Press [Device Information] in the home screen and then [Identification/Network] to check the machine's IP address or the host name.

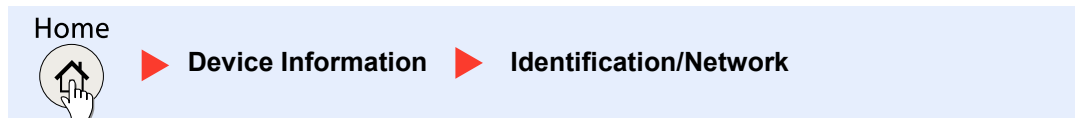

3 Log in with administrator privileges.

The factory default setting for the default user with administrator privileges is shown below.

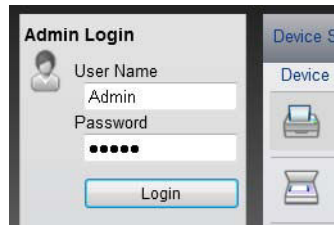

<b>Login User Name</b>	<b>Admin</b>
<b>Login Password</b>	<b>Admin</b>

\* Upper case and lower case letters are distinguished (case sensitive).

4 Click [[Security Settings](#)].

## 2 Configure the Security Settings.

From the [\[Security Settings\]](#) menu, select the setting you want to configure.

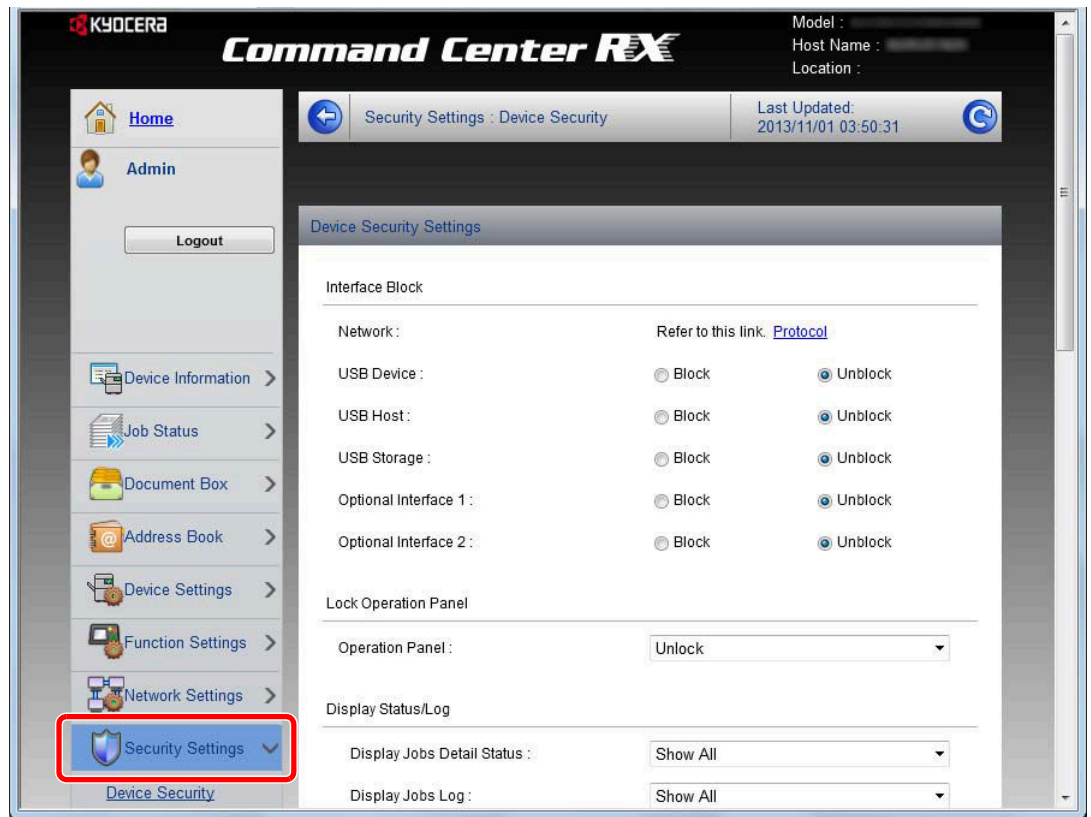

### NOTE

- The configurable settings within [\[Device Security\]](#), [\[Send Security\]](#), and [\[Network Security\]](#) can also be configured from the machine's System Menu. For details, see [Setup and Registration \(System Menu\) \(page 8-1\)](#).
- For details on settings related to certificates, refer to the **Command Center RX User Guide**.

## Changing Device Information

Change the device information of the machine.

### 1 Display the screen.

- 1 Launch your Web browser.
- 2 In the address or location bar, enter the machine's IP address or the host name.  
Press [Device Information] in the home screen and then [Identification/Network] to check the machine's IP address or the host name.

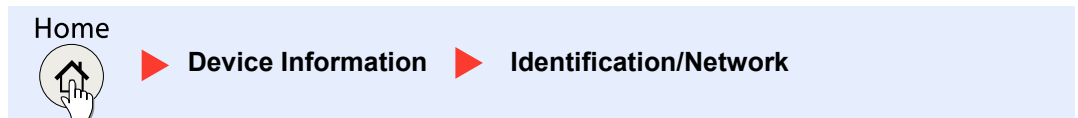

### 3 Log in with administrator privileges.

The factory default setting for the default user with administrator privileges is shown below.

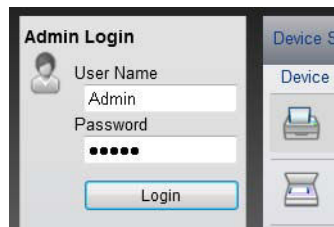

Login User Name	Admin
Login Password	Admin

\* Upper case and lower case letters are distinguished (case sensitive).

### 4 From the [Device Settings] menu, select [System].

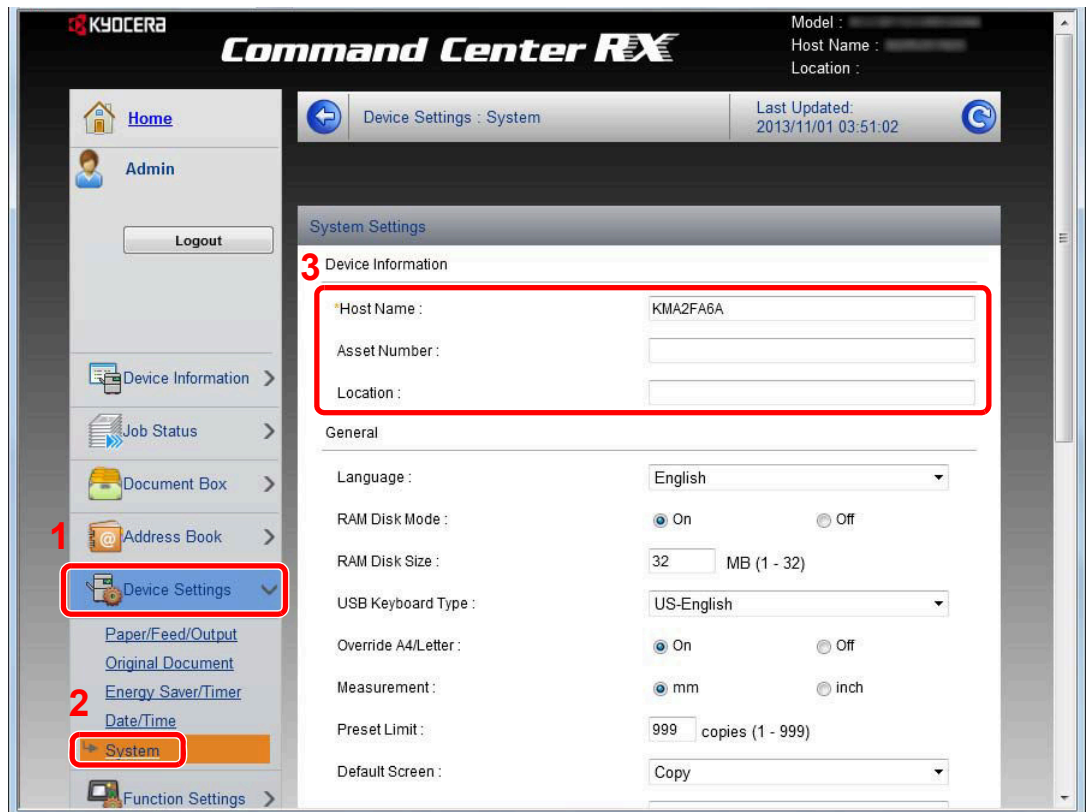

## 2 Specify the host name.

Enter the device information, and then click [\[Submit\]](#).

 **IMPORTANT**

- After changing the setting, restart the network or turn the machine OFF and then ON.
- To restart the network interface card, click [\[Reset\]](#) in the [\[Management Settings\]](#) menu, and then click [\[Restart Network\]](#) in “Restart”.

## E-mail Settings

By configuring the SMTP settings, it is possible to send the images scanned by the machine as E-mail attachments and to send E-mail notices when jobs have been completed.

To use this function, this machine must be connected to a mail server using the SMTP protocol.

In addition, configure the following.

- SMTP settings  
Item: "SMTP Protocol" and "SMTP Server Name" in "SMTP"
- The sender address when the machine sends E-mails  
Item: "Sender Address" in "E-mail Send Settings"
- The setting to limit the size of E-mails  
Item: "E-mail Size Limit" in "E-mail Send Settings"

The procedure for specifying the SMTP settings is explained below.

### 1 Display the screen.

Display the SMTP Protocol screen.

1 Launch your Web browser.

2 In the address or location bar, enter the machine's IP address or the host name.

Press [Device Information] in the home screen and then [Identification/Network] to check the machine's IP address or the host name.

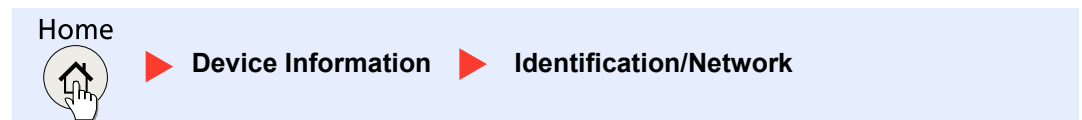

3 Log in with administrator privileges.

The factory default setting for the default user with administrator privileges is shown below.

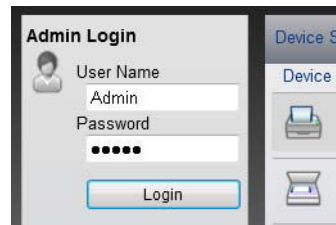

<b>Login User Name</b>	<b>Admin</b>
<b>Login Password</b>	<b>Admin</b>

\* Upper case and lower case letters are distinguished (case sensitive).

4 From the [Network Settings] menu, click [Protocol].

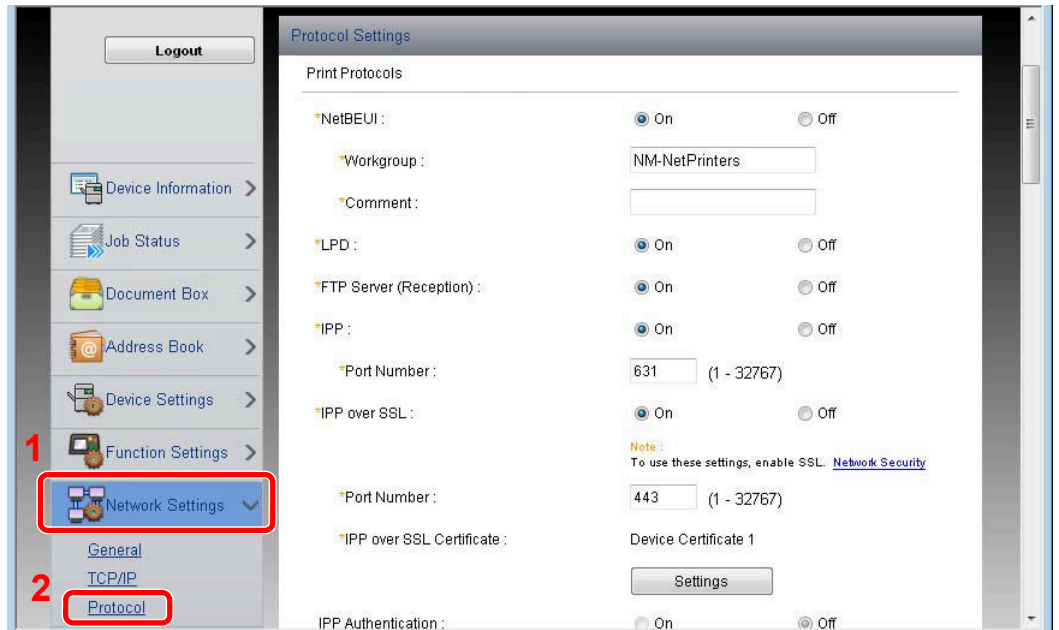

## 2 Configure the settings.

Set "SMTP (E-mail TX)" to [On] in the "Send Protocols".

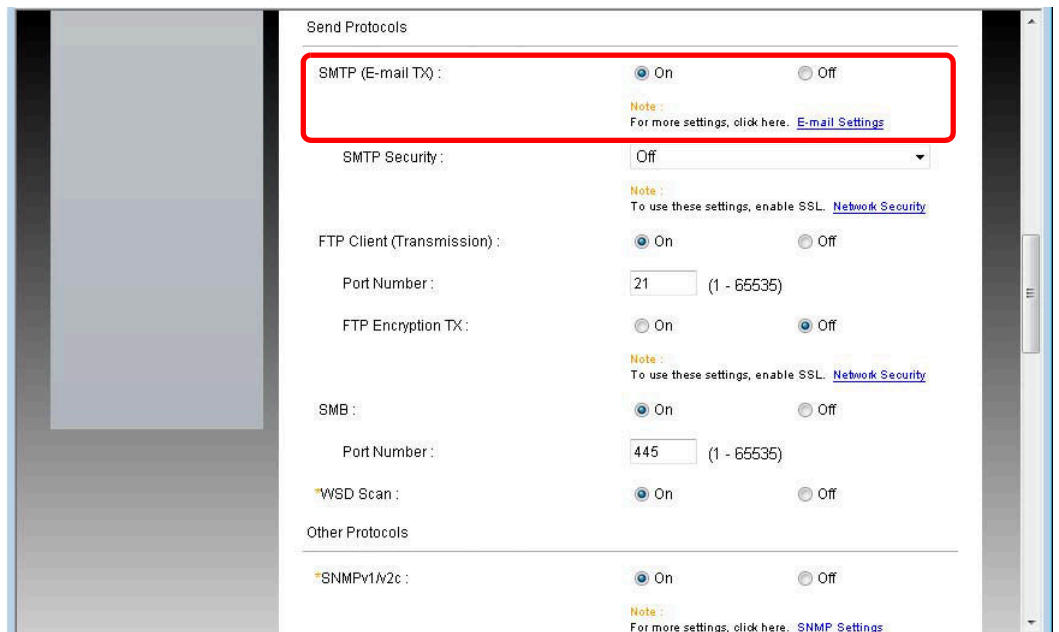

### 3 Display the screen.

Display the E-mail Settings screen.

From the [Function Settings] menu, click [E-mail].

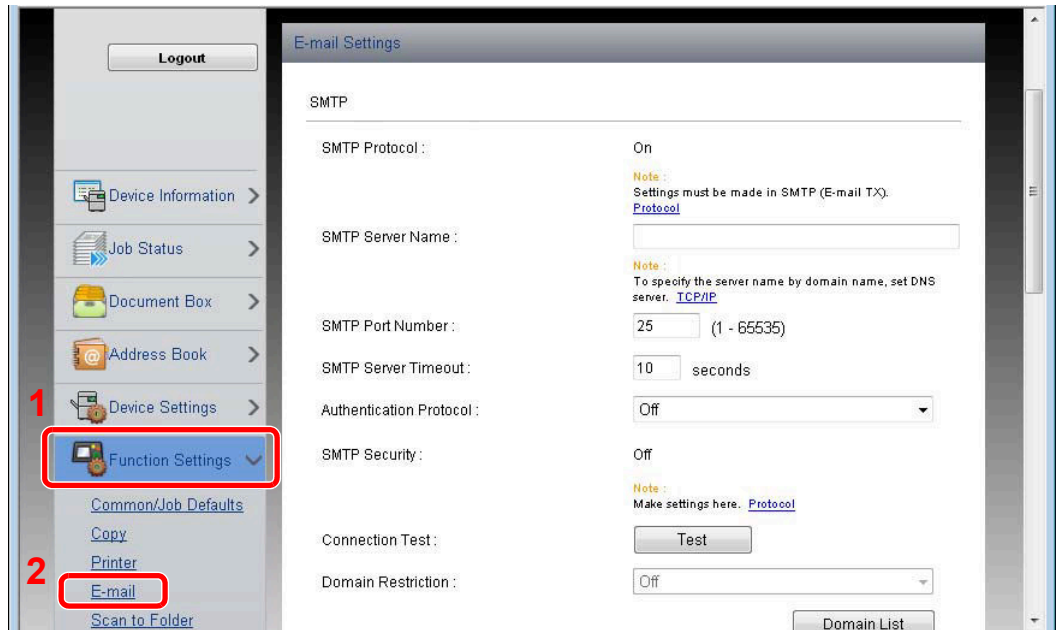

## 4 Configure the settings.

Enter "SMTP" and "E-mail Send Settings" items.

Setting	Description	
<b>SMTP</b>	Set to send e-mail from the machine.	
<b>SMTP Protocol</b>	Displays the SMTP protocol settings. Check that "SMTP Protocol" is set to <b>[On]</b> . If <b>[Off]</b> is set, click <b>[Protocol]</b> and set the SMTP protocol to <b>[On]</b> .	
<b>SMTP Server Name*<sup>1</sup></b>	Enter the host name or IP address of the SMTP server.	
<b>SMTP Port Number</b>	Specify the port number to be used for SMTP. Use the SMTP default port 25.	
<b>SMTP Server Timeout</b>	Set the amount of time to wait before time-out in seconds.	
<b>Authentication Protocol</b>	To use SMTP authentication, enter the user information for authentication.	
<b>SMTP Security</b>	Set SMTP security. Turn on "SMTP Security" in "SMTP (E-mail TX)" on the <b>[Protocol Settings]</b> page.	
<b>POP before SMTP Timeout</b>	Specify the time in seconds until the connection to the POP server times out. This can be set when <b>[POP before SMTP]</b> is selected in "Authentication Protocol".	
<b>Connection Test</b>	Tests to confirm that the settings are correct.	
<b>Domain Restriction</b>	To restrict the domains, click the <b>[Domain List]</b> and enter the domain names of addresses to be allowed or rejected. Restriction can also be specified by e-mail address.	
<b>POP3</b>	You don't need to set the following items when you only enable the function of sending e-mail from the machine. Set the following items if you want to enable the function of receiving e-mail on the machine. For more information, refer to <b>Command Center RX User Guide</b> .	
<b>POP3 Protocol</b>		
<b>Check Interval</b>		
<b>Run once now</b>		
<b>Domain Restriction</b>		
<b>POP3 User Settings</b>		
<b>E-mail Send Settings</b>	<b>E-mail Size Limit</b>	Enter the maximum size of E-mail that can be sent in kilobytes. When E-mail size is greater than this value, an error message appears and E-mail sending is cancelled. Use this setting if you have set E-mail Size Limit for SMTP server. If not, enter a value of 0 (zero) to enable E-mail sending regardless of the size limit.
	<b>Sender Address*<sup>1</sup></b>	Specify the sender address for when the machine sends E-mails, such as the machine administrator, so that a reply or non-delivery report will go to a person rather than to the machine. The sender address must be entered correctly for SMTP authentication. The maximum length of the sender address is 128 characters.
	<b>Signature</b>	Enter the signature. The signature is free form text that will appear at the end of the E-mail body. It is often used for further identification of the machine. The maximum length of the signature is 512 characters.
	<b>Function Defaults</b>	Change the function default settings in <b>[Common/Job Default Settings]</b> page.

\*1 Be sure to enter the items.

## 5 Click **[Submit]**.



## Registering Destinations

You can register destinations to the machine's Address Book, from Command Center RX.

### 1 Display the screen.

- 1 Launch your Web browser.
- 2 In the address or location bar, enter the machine's IP address or the host name.  
Press [Device Information] in the home screen and then [Identification/Network] to check the machine's IP address or the host name.

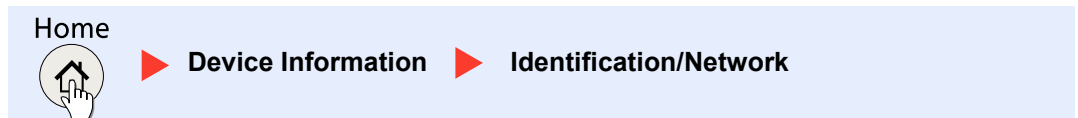

### 3 Log in with administrator privileges.

The factory default setting for the default user with administrator privileges is shown below.

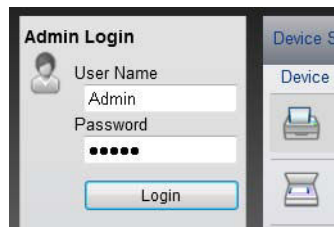

<b>Login User Name</b>	Admin
<b>Login Password</b>	Admin

\* Upper case and lower case letters are distinguished (case sensitive).

### 4 From the [Address Book] menu, click [Machine Address Book].



### 5 Click [Add].

## 2 Populate the fields.

- 1 Enter the destination information.

Enter the information for the destination you want to register. The fields to populate are the same as when registering via operation panel.



[Registering Destinations in the Address Book \(page 3-35\)](#)

- 2 Click [**Submit**].

## Creating a New Custom Box

You can register a custom box from Command Center RX.



### NOTE

To use Custom Box, an optional SSD must be installed in the machine.

## 1 Display the screen.

- 1 Launch your Web browser.
- 2 In the address or location bar, enter the machine's IP address or the host name.  
Press [Device Information] in the home screen and then [Identification/Network] to check the machine's IP address or the host name.

Home



Device Information



Identification/Network

- 3 From the [Document Box] menu, click [Custom Box].

The screenshot shows the Command Center RX web interface. The top navigation bar includes 'Home', 'Admin', and 'Logout'. The main content area is titled 'Document Box : Custom Box' and shows a table of 'Custom Boxes'. The table has columns for 'No.', 'Type', 'Box Name', 'Owner', 'Files', and 'Size'. There are three rows of boxes: '0001 Box 01' (2 files, 239.0 KB), '0002 Box 02' (0 files, 0.0 KB), and '0003 Box 03' (0 files, 0.0 KB). An 'Add' button is circled in red and labeled with a red '3'. The 'Document Box' menu item is circled in red and labeled with a red '1', and the 'Custom Box' sub-menu item is circled in red and labeled with a red '2'.

No.	Type	Box Name	Owner	Files	Size
0001	Folder	Box 01		2	239.0 KB
0002	Folder	Box 02		0	0.0 KB
0003	Folder	Box 03		0	0.0 KB

- 4 Click [Add].

## 2 Configure the Custom Box.

- 1 Enter the box details.  
Enter the information for the custom box you want to register. For details on the fields to populate, refer to **Command Center RX User Guide**.
- 2 Click [Submit].

## Printing a document stored in a Custom Box

A document stored in a Custom Box can be printed from Command Center RX.

### 1 Display the screen.

- 1 Launch your Web browser.
- 2 In the address or location bar, enter the machine's IP address or the host name.  
Press [Device Information] in the home screen and then [Identification/Network] to check the machine's IP address or the host name.

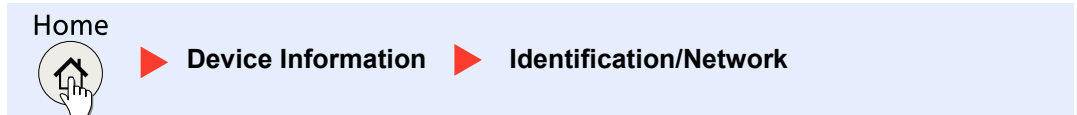

- 3 From the [Document Box] menu, click [Custom Box].



- 4 Click the number or name of the Custom Box in which the document is stored.

## 2 Print the document.

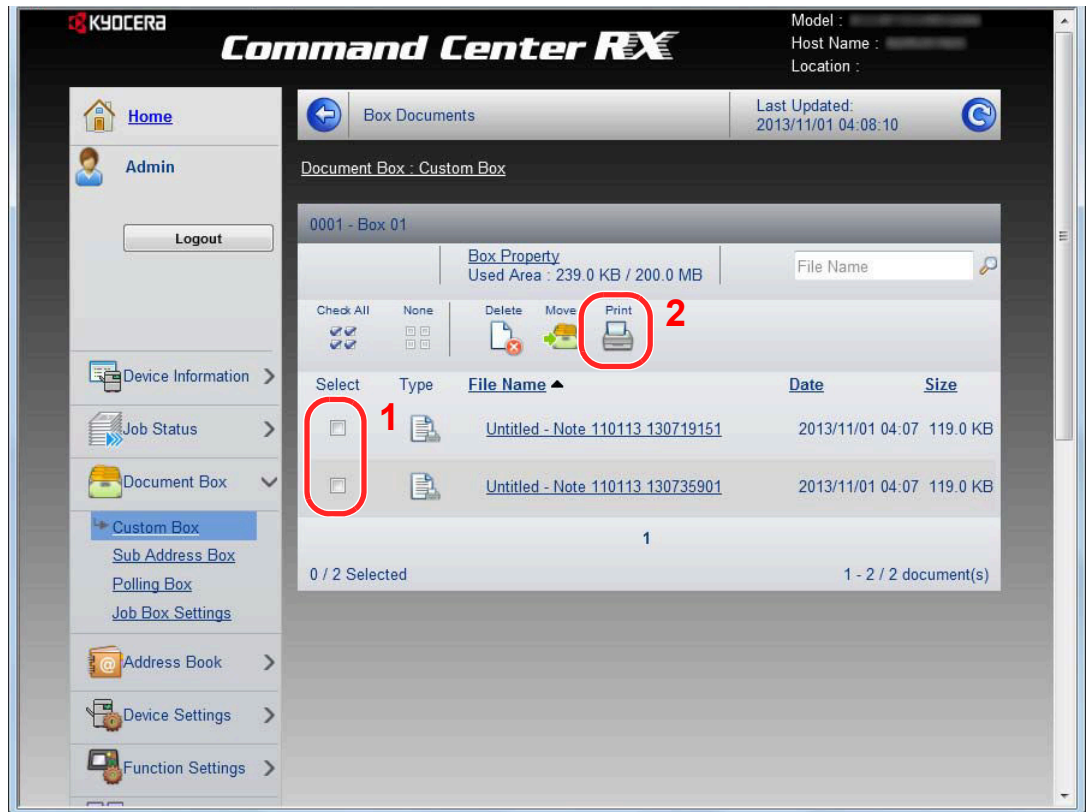

- 1 Select the document you wish to print.

Select the checkbox of the document to be printed.

- 2 Click [**Print**].

For settings that are configurable, refer to **Command Center RX User Guide**.

# Transferring Data from Our Other Products

By using the machine's utility, you can smoothly migrate address books when the machine is to be replaced. This section explains how to transfer data between our products.

## Migrating the Address Book

The Address Book registered on the machine can be backed up or migrated using the KYOCERA Net Viewer on the included DVD.

For details on operating the KYOCERA Net Viewer, refer to the **KYOCERA Net Viewer User Guide**.

### Backing Up Address Book Data to PC

#### 1 Launch the KYOCERA Net Viewer.

#### 2 Create a backup.

- 1 Right-click on the model name from which you want to back up the Address Book, and select **[Advanced]** - **[Set multiple devices]**.

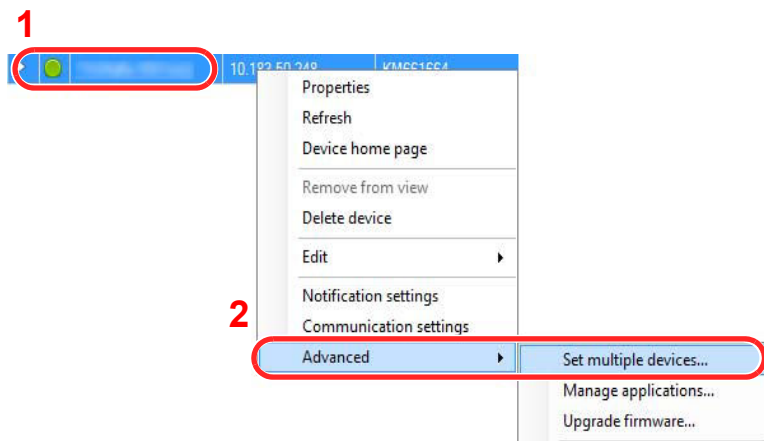

- 2 Click **[Next]**.

- 3 Select **[Device Address Book]** and click **[Next]**.

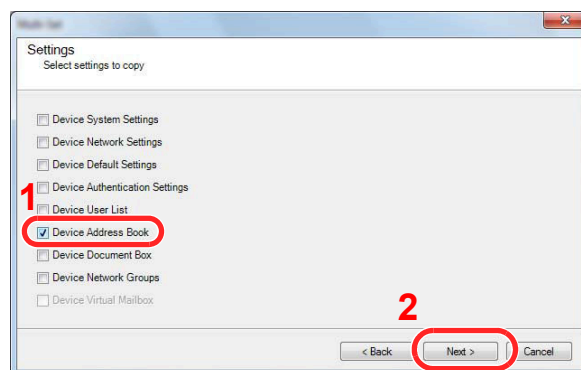

- 4 Select [**Create from device**] and remove the checkmark from [**Overwrite settings on target device**], and then click [**Next**].

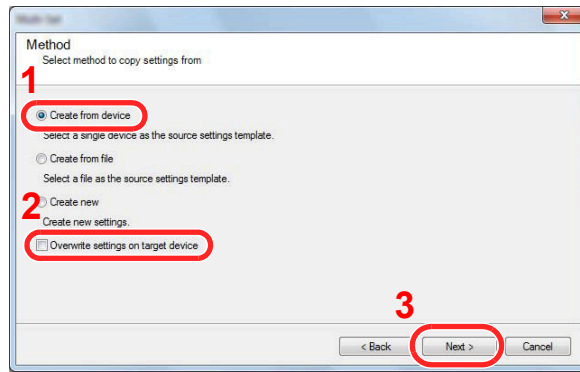

- 5 Select the model you want to back up, and click [**Next**].

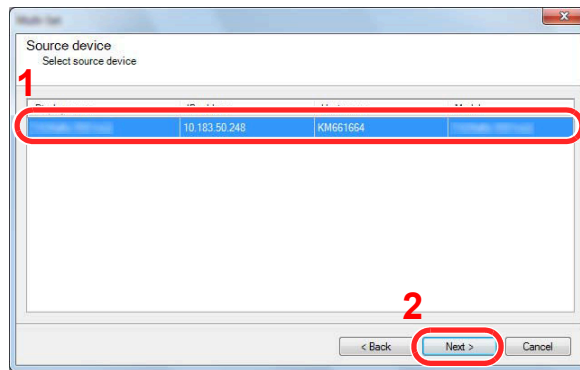

 **NOTE**

If the "Admin Login" screen appears, enter the "Admin Login" and "Login Password", and then click [**OK**]. The default settings are as follows:

<b>Login User Name</b>	<b>Admin</b>
<b>Login Password</b>	<b>Admin</b>

\* Upper case and lower case letters are distinguished (case sensitive).

- 6 Click on [**Save to file**].

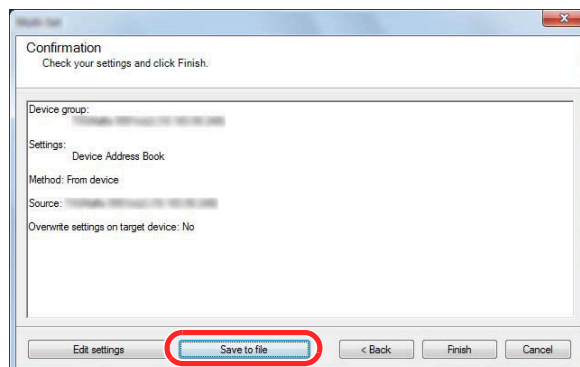

- 7 Specify the location to save the file, enter the file name, and then click [**Save**].  
For "Save as type", make sure to select "XML File".

- 8 After saving the file, always click [**Cancel**] to close the screen.

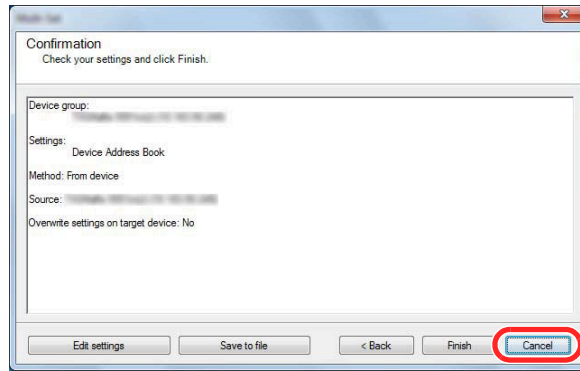

Please note that selecting [**Finish**] will write the data to the machine's Address Book.

## Writing Address Book Data to the Machine

- 1 **Launch the KYOCERA Net Viewer.**

- 2 **Load the Address Book data.**

- 1 Right-click on the model name to which you want to transfer the Address Book, and select [**Advanced**] - [**Set multiple devices**].

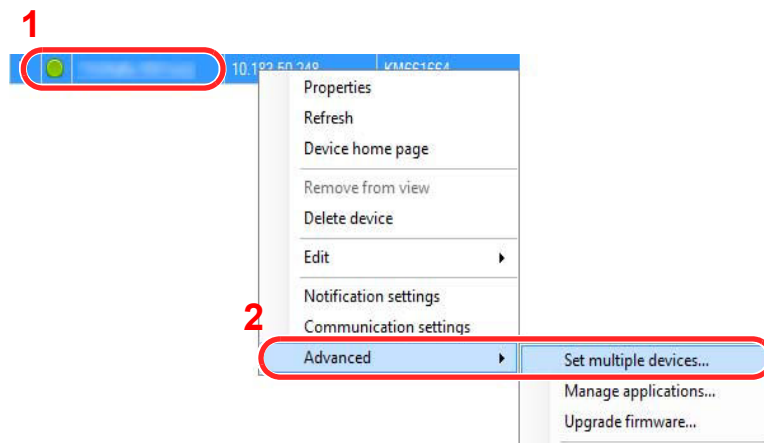

- 2 Click [**Next**].

- 3 Select [**Device Address Book**] and click [**Next**].

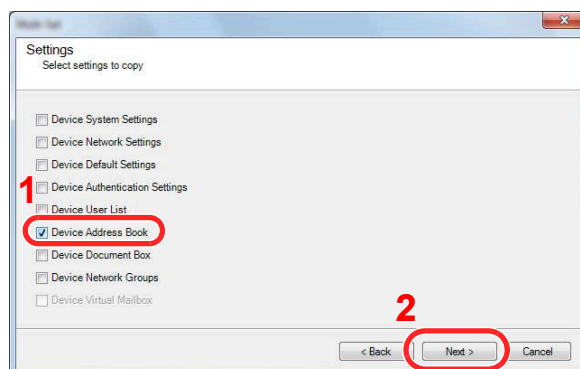



- 4 Select **[Create from file]** and remove the checkmark from **[Overwrite settings on target device]**, and then click **[Next]**.

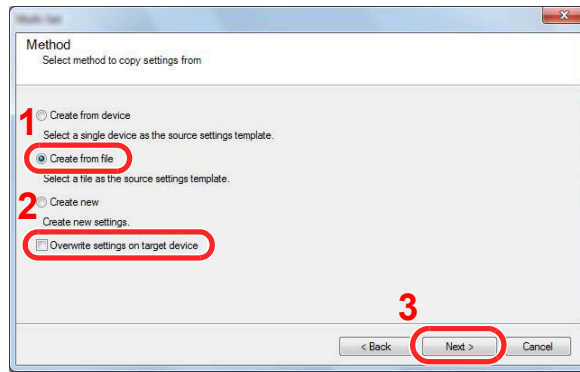

Selecting the **[Overwrite settings on target device]** checkbox will overwrite the machine's Address Book from entry No.1.

- 5 Click **[Browse]** and select the backup Address Book file, and then click **[Next]**.

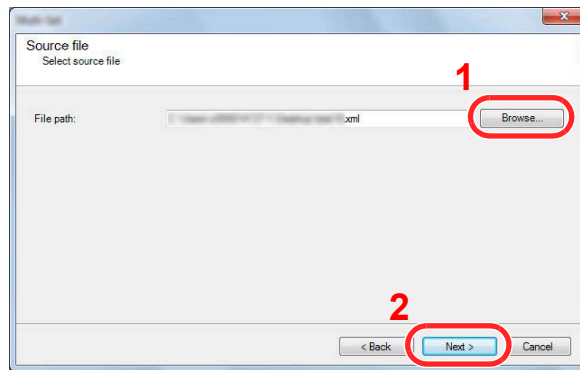

- 6 Click **[Finish]**.

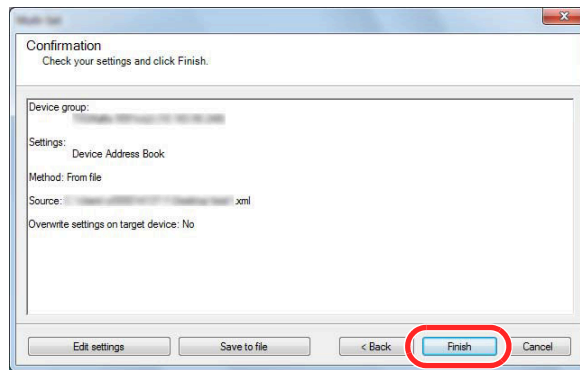

The write process of the Address Book data starts.

- 7 Once the write process is complete, click **[Close]**.





# 3 Preparation before Use

This chapter explains the following operations.

Using the Operation Panel .....	3-2
Operation Panel Keys .....	3-2
Adjusting the Operation Panel Angle .....	3-3
Touch Panel Display .....	3-4
Home Screen .....	3-4
Display for Device Information .....	3-8
Display of Keys That Cannot Be Set .....	3-9
Enter key and Quick No. Search key .....	3-10
Help Screen .....	3-11
Loading Paper .....	3-12
Precaution for Loading Paper .....	3-13
Loading in the Cassettes .....	3-14
Loading Paper in the Multi Purpose Tray .....	3-18
Specifying Paper Size and Media Type .....	3-22
Paper Stopper .....	3-24
Preparation for Sending a Document to a Shared Folder in a PC .....	3-25
Making a note of the computer name and full computer name .....	3-25
Making a note of the user name and domain name .....	3-26
Creating a Shared Folder, Making a Note of a Shared Folder .....	3-27
Configuring Windows Firewall .....	3-31
Registering Destinations in the Address Book .....	3-35
Adding a Destination (Address Book) .....	3-35
Adding a Destination on One Touch Key (One Touch Key) .....	3-41

# Using the Operation Panel



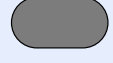





## Operation Panel Keys

<b>Home</b> 	Displays the Home screen.	<b>Status/Job Cancel</b> 	Displays the Status/Job Cancel screen.	<b>Send</b> 	Displays the screen for sending. You can change it to display the Address Book screen.
		<b>Copy</b> 	Displays the Copy screen.	<b>FAX</b> 	Displays the FAX screen.

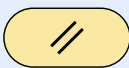

Touch panel.  
Displays buttons for configuring machine settings.

Blinks while printing or sending/receiving.  
Blinks while the machine is accessing the machine memory, fax memory or USB memory (general purpose item).  
Lights or blinks when an error occurs and a job is stopped.

<b>System Menu / Counter</b> 	Displays the System Menu/Counter screen.	<b>Authentication/Logout</b> 	Authenticates user switching, and exits the operation for the current user (i.e. log out).	<b>Energy Saver</b> 	Puts the machine into Sleep Mode. Recovers from Sleep if in Sleep Mode.
	Numeric keys. Enter numbers and symbols.	<b>Clear</b> 	Clears entered numbers and characters.	<b>Reset</b> 	Returns settings to their default states.
		<b>Quick No. Search</b> 	Specifies registered information such as address numbers and user IDs by number.	<b>Stop</b> 	Cancels or pauses the job in progress.
		<b>Enter</b> 	Finalizes numeric key entry, and finalizes details during setting of functions. Operates linked with the on-screen [OK].	<b>Start</b> 	Starts copying and scanning operations and processing for setting operations.

## Adjusting the Operation Panel Angle

The angle of the operation panel can be adjusted. Keep the angle adjustment tab pressed and the angle can be adjusted in 2 stages.

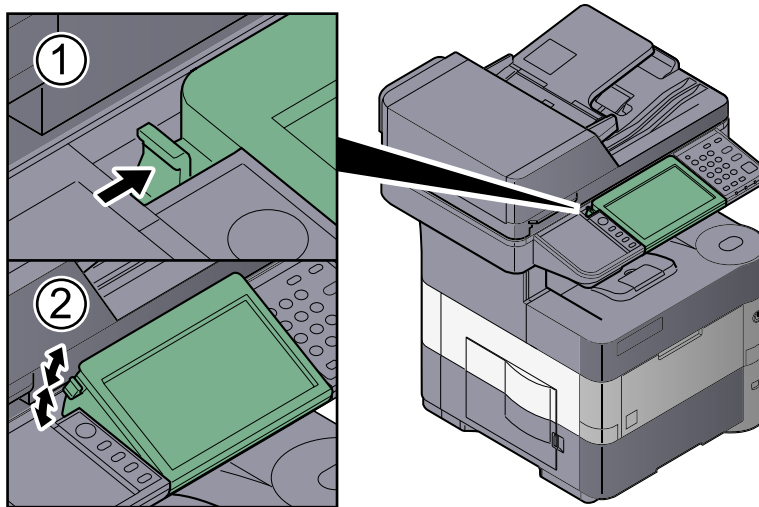

# Touch Panel Display

## Home Screen

This screen is displayed by pressing the [Home] key on the operation panel. Touching an icon will display the corresponding screen.

You can change the icons to display on the Home screen as well as its background.

 [Editing the Home Screen \(page 3-5\)](#)

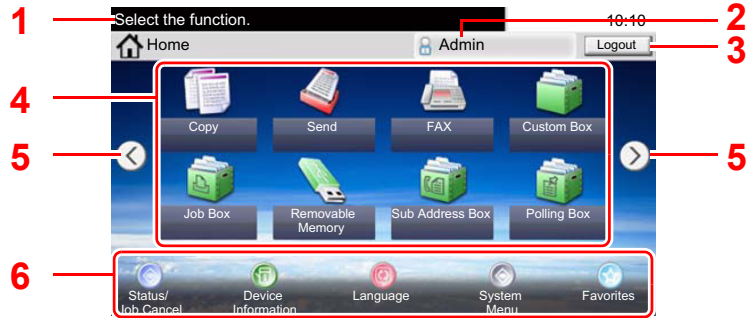

\* The appearance may differ from your actual screen, depending on your configuration and option settings.

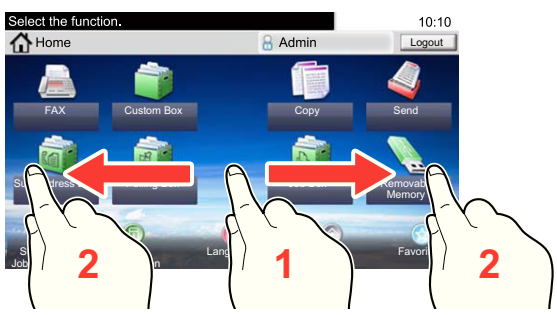
No.	Item	Description
1	Message	Displays the message depending on the status.
2	Login User Name	Displays the logged-in user name. This is displayed when user login administration is enabled. Pressing "Login User Name" will display the information of the logged-in user.
3	[Logout]	Logs out the current user. This is displayed when user login administration is enabled.
4	Desktop	Displays a maximum of 40 function icons* <sup>1</sup> including the functions registered in favorite. Icons that are not displayed on the first page will appear by changing the page.
5	Screen-switching keys	Use these buttons to switch between desktop pages.  <b>NOTE</b> You can also switch views by touching the screen and moving the finger sideways (i.e. swiping). 
6	Taskbar	Displays a maximum of 5 task icons.

\*1 A maximum of 42 icons can be displayed on products with the fax function installed. A maximum of 5 icons can be displayed for installed applications.

## Editing the Home Screen

You can change the background of the Home screen as well as which icons are displayed.

### 1 Display the screen.

- 1 Press the [System Menu] key, [∨], and then [Home].

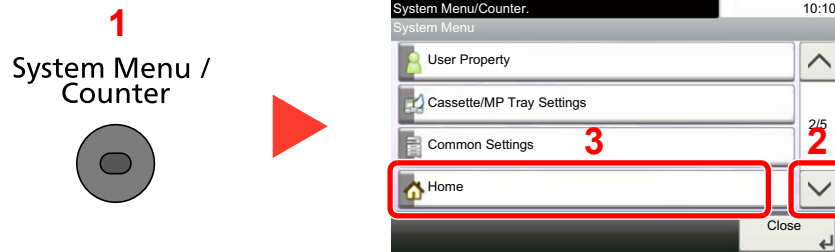

#### NOTE

You can only change the settings by logging in with administrator privileges.  
The factory default login user name and login password are set as shown below.











Model Name	Login User Name	Login Password
ECOSYS M3040idn/ ECOSYS M3540idn	4000	4000
ECOSYS M3550idn	5000	5000
ECOSYS M3560idn	6000	6000

### 2 Configure the settings.

The available settings are shown below.

Item	Description
<b>Customize Desktop</b>	Specify the function icons to display on the desktop. Press [ + ] to display the screen for selecting the function to display. Select the function to display and press [OK]. Select an icon and press [Previous] or [After] to change the display position of the selected icon on the Desktop. To delete an icon from desktop, select the desired one and press [  ]. For details, refer to <a href="#">Available Functions to Display on Desktop on page 3-6</a> .
<b>Customize Taskbar</b>	Specify the task icons to display on the taskbar. For details, refer to <a href="#">Available Functions to Display on Taskbar on page 3-7</a> .
<b>Wallpaper</b>	Configure the wallpaper of the Home screen. <b>Value:</b> Images 1 to 8

## Available Functions to Display on Desktop

Function	Icon	Description	Reference page
Copy <sup>*1</sup>		Displays the Copy screen.	<a href="#">page 5-16</a>
Send <sup>*1</sup>		Displays the Send screen.	<a href="#">page 5-19</a>
FAX <sup>*2</sup>		Displays the FAX screen.	Refer to the <b>FAX Operation Guide</b> .
Custom Box <sup>*3</sup>		Displays the Custom Box screen.	<a href="#">page 5-43</a>
Job Box <sup>*1</sup>		Displays the Job Box screen.	<a href="#">page 4-8</a> <a href="#">page 5-41</a>
Removable Memory <sup>*1</sup>		Displays the Removable Memory screen.	<a href="#">page 5-50</a>
Sub Address Box <sup>*2</sup>		Displays the Sub Address Box screen.	Refer to the <b>FAX Operation Guide</b> .
Polling Box <sup>*2</sup>		Displays the Polling Box screen.	Refer to the <b>FAX Operation Guide</b> .
Send to Me (E-mail) <sup>*4</sup>		Displays the Send screen. The E-mail address of the logged-in user is set as the destination.	<a href="#">page 5-32</a>
Favorites		Calls up the registered favorite. The icon will change according to the function of the favorite.	<a href="#">page 5-5</a>
Application Name	 <sup>*5</sup>	Displays the selected applications.	<a href="#">page 5-11</a>

\*1 Selected at the time of shipment from factory.





\*2 Displayed only on products with the fax function installed.

\*3 Displayed when the optional SSD is installed.

\*4 Displayed when user login administration is enabled.

\*5 The icon of the application appears.

**Available Functions to Display on Taskbar**

Function	Icon	Description	Reference page
<b>Status/Job Cancel</b>		Displays the Status screen. If an error occurs, the icon will show "!". Once the error clears, the display will return to normal.	-
<b>Device Information</b>		Displays the Device Information screen. Check the system and network information. You can also check information on the options that are used.	<a href="#">page 3-8</a>
<b>Language</b>		Displays the Language setting screen in System Menu.	<a href="#">page 8-6</a>
<b>System Menu</b>		Displays the System Menu screen.	<a href="#">page 8-2</a>
<b>Favorites</b>		Displays the favorite list screen.	<a href="#">page 5-5</a>



## Display for Device Information

Shows device information. Allows you to check system and network information, as well as options that are used.

- 1 Press [Device Information] in the home screen.



- 2 Check the device information.

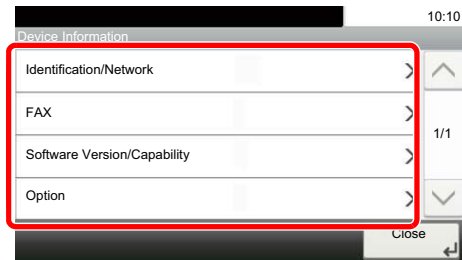

Tab	Description
<b>Identification/Network</b>	You can check ID information such as the model name, serial number, host name and location, and the IP address.
<b>FAX<sup>*1</sup></b>	You can check the local fax number, local fax name, local fax ID and other fax information.
<b>Software Ver./Capability</b>	You can check the software version and performance.
<b>Option</b>	You can check information on the options that are used.

\*1 Displayed only on products with the fax function installed.

## Display of Keys That Cannot Be Set

Keys of features that cannot be used due to feature combination restrictions or non-installation of options are in a non-selectable state.

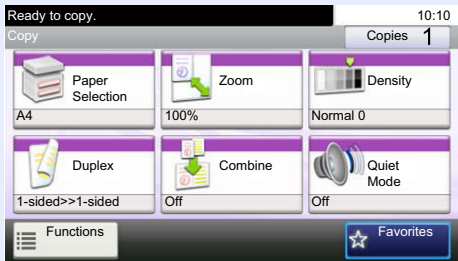
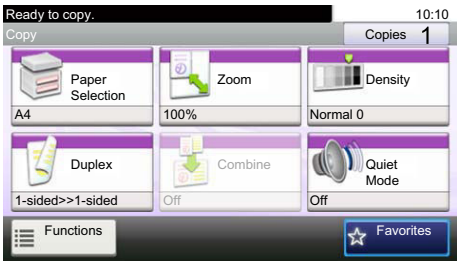
Normal	Grayed out
	 <p data-bbox="805 651 1279 707">In the following cases, the key is grayed out and cannot be selected.</p> <ul data-bbox="805 719 1252 779" style="list-style-type: none"> <li>• Cannot be used in combination with a feature that is already selected.</li> </ul>

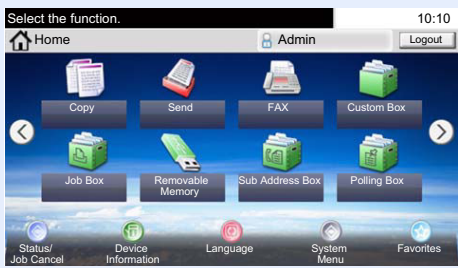
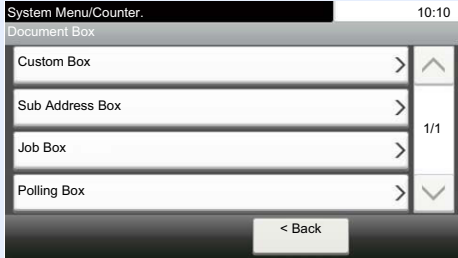
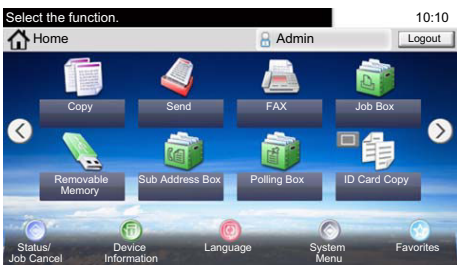
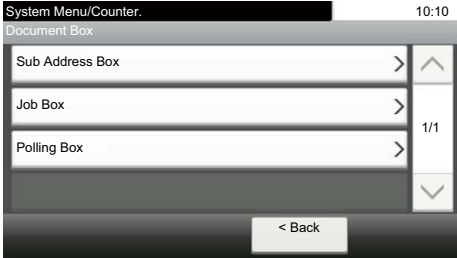
Normal	Hidden
 	  <p data-bbox="805 1451 1311 1574">Cannot be used because an option is not installed. Example: When a SSD is not installed, [Custom Box] does not appear.</p>

**NOTE**  
If a key that you wish to use is grayed out, the settings of the previous user may still be in effect. In this case, press the **[Reset]** key and try again.

## Enter key and Quick No. Search key

This section explains how to use the [Enter] key and [Quick No. Search] key on the operation panel.

### Using the [Enter] key ( )

The [Enter] key has the same function as the key with the Enter mark (↵), such as the [OK ↵] key and the [Close ↵].

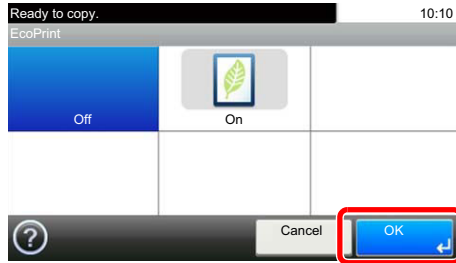

### Using the [Quick No. Search] key ( )

The [Quick No. Search] key is used when using the numeric keys to directly enter the number, for example, when specifying the destination for the transmission using a speed-dial number.

 For more information on speed dialing, refer to [Specifying Destination on page 5-22](#).

Quick No.  
Search

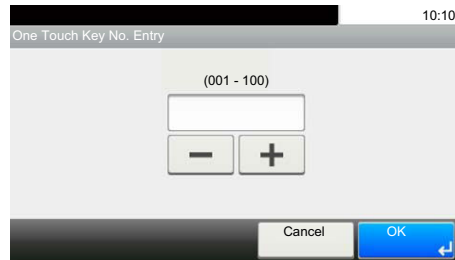
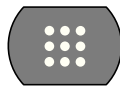

## Help Screen

If you have difficulty operating the machine, you can check how to operate it using the touch panel.

When the [?] (help) is displayed on the touch panel, you can press it to display the Help screen. The Help screen shows explanations of functions and how to use them.

Example: Checking the paper selection Help screen

### 1 Referring to [Paper Selection on page 6-9](#), display the Paper Selection screen.



### 2

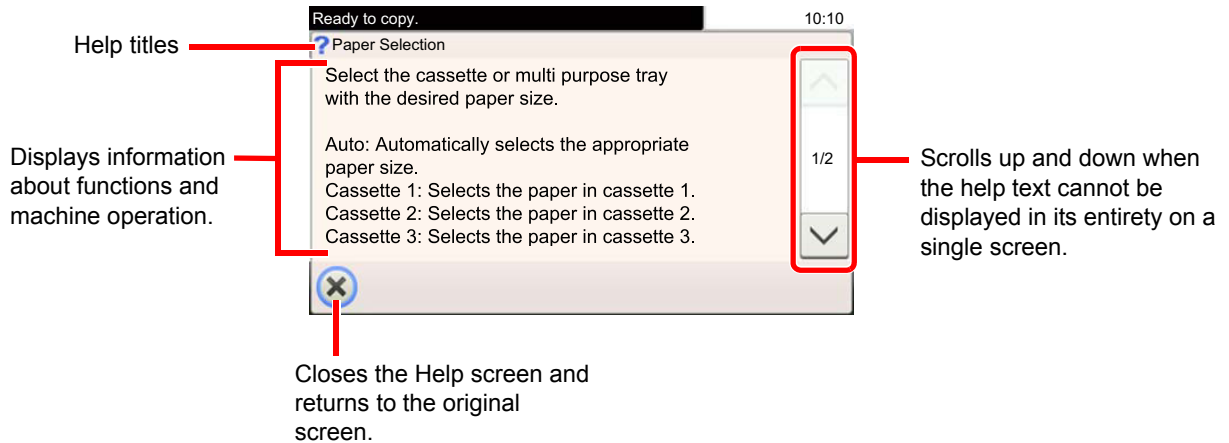
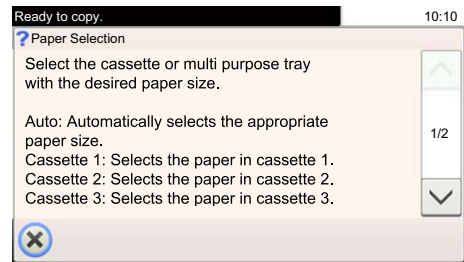
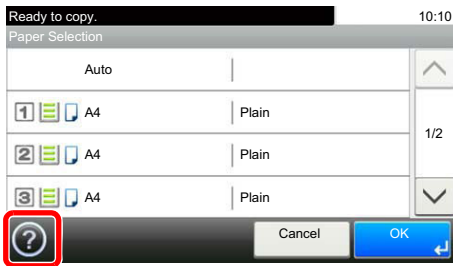

# Loading Paper

Load paper in the cassettes and multipurpose tray.

For the paper load methods for each cassette, refer to the page below.

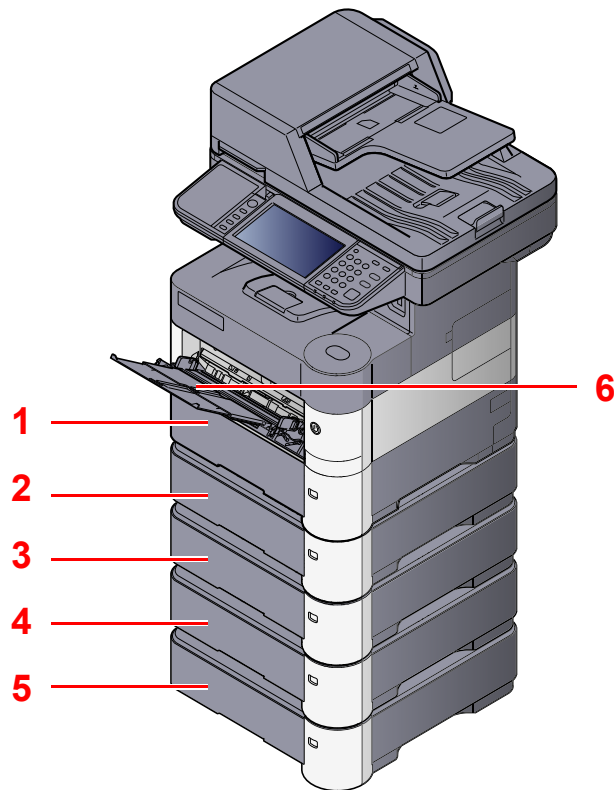

No.	Name	Page
1	Cassette 1	<a href="#">page 3-14</a>
2	Cassette 2	<a href="#">page 3-14</a>
3	Cassette 3	<a href="#">page 3-14</a>
4	Cassette 4	<a href="#">page 3-14</a>
5	Cassette 5	<a href="#">page 3-14</a>
6	Multi Purpose Tray	<a href="#">page 3-18</a>

## NOTE

- The number of sheets that can be held varies depending on your environment and paper type.
- You should not use inkjet printer paper or any paper with a special surface coating. (Such paper may cause paper jams or other faults.)

## Precaution for Loading Paper

When you open a new package of paper, fan the sheets to separate them slightly prior to loading in the following steps.

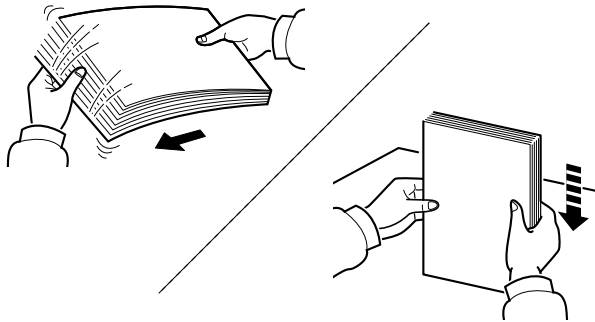

Fan the paper, then tap it on a level surface.

In addition, note the following points.

- If the paper is curled or folded, straighten it before loading. Paper that is curled or folded may cause a jam.
- Avoid exposing opened paper to high temperatures and high humidity as dampness can be a cause of problems. Seal any remaining paper after loading in the multi purpose tray or cassettes back in the paper storage bag.
- If the machine will not be used for a prolonged period, protect all paper from humidity by removing it from the cassettes and sealing it in the paper storage bag.

### ✔ IMPORTANT

**If you copy onto used paper (paper already used for printing), do not use paper that is stapled or clipped together. This may damage the machine or cause poor image quality.**

### 💡 NOTE

Note that some paper types have a tendency to curl and may jam in the paper eject unit. If you use special paper such as letterhead, paper with holes or paper with pre-prints like logo or company name, refer to [Paper on page 11-15](#).

## Loading in the Cassettes

The cassettes can hold plain paper, recycled paper or color paper.

Cassette 1 to 5 hold up to 500 sheets of plain paper (80 g/m<sup>2</sup>).

For details of the supported paper sizes, refer to [Choosing the Appropriate Paper on page 11-16](#). For the paper type setting, refer to [Media Type Setting on page 8-14](#).

### ✔ IMPORTANT

- The cassettes can hold paper with weight between 60 - 120 g/m<sup>2</sup>.
- Do not load thick paper that is heavier than 120 g/m<sup>2</sup> in the cassettes. Use the multi purpose tray for paper that is heavier than 120 g/m<sup>2</sup>.

## 1 Pull the cassette completely out of the machine.

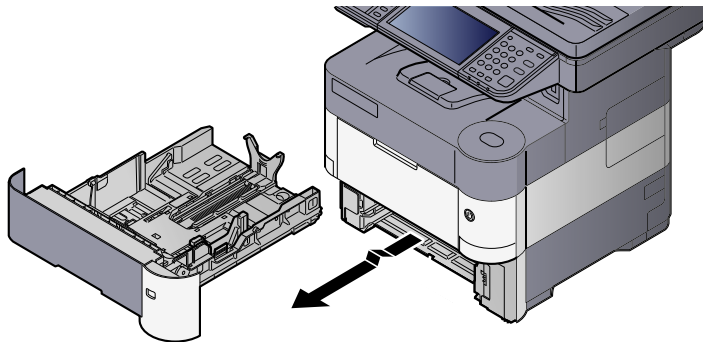

### NOTE

When pulling the cassette out of the machine, ensure it is supported and does not fall out.

## 2 Adjust the cassette size.

- 1 Adjust the position of the paper width guides located on the left and right sides of the cassette. Press the paper width adjusting tab and slide the guides to the paper size required.

Paper sizes are marked on the cassette.

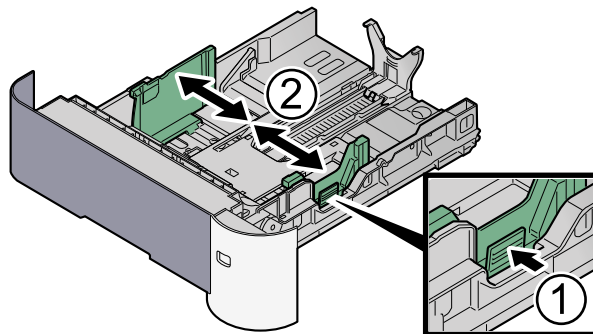

- Adjust the paper length guide to the paper size required. Press the paper length adjusting tab and slide the guides to the paper size required.

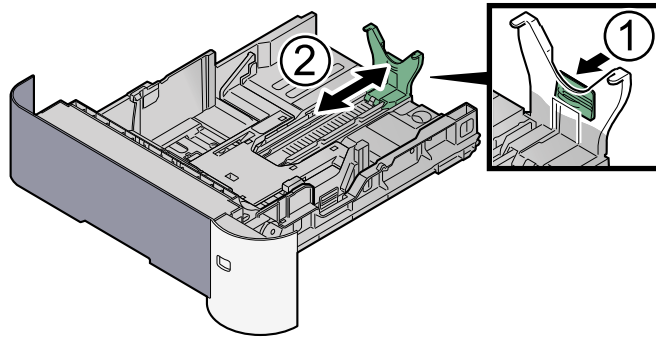

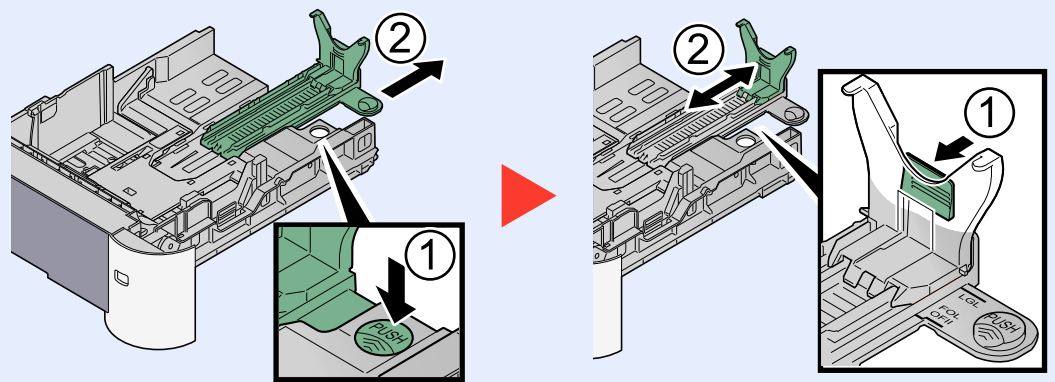

 **NOTE**

If you are going to use paper that is longer than A4, pull out the paper length guide backwards.

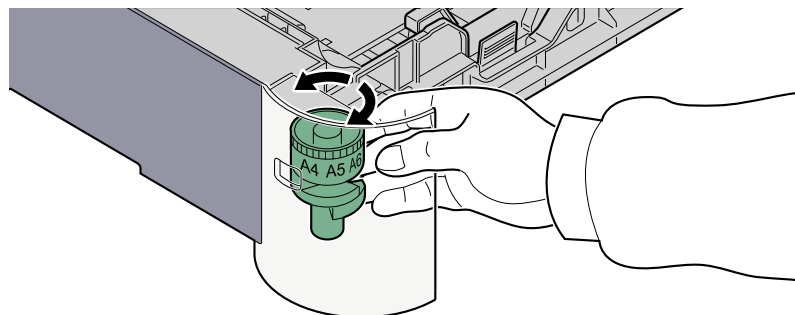

- Turn the size dial so that the size of the paper you are going to use appears in the paper size window.



 **NOTE**

When the size dial is set to "Other" the paper size must be set into the machine on the operation panel. Refer to [Paper Size and Media Type for the Cassettes on page 3-22](#).



**3 (On ECOSYS M3040idn/ECOSYS M3540idn only) Press the bottom plate down until it locks.**

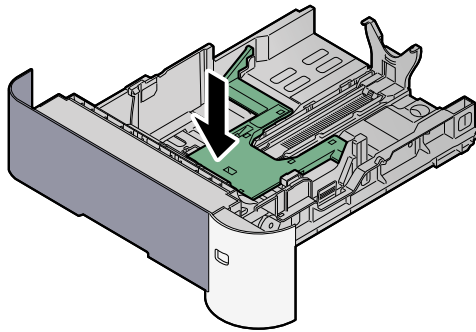

**4 Load paper.**

- 1 Fan the paper, then tap it on a level surface to avoid paper jams or skewed printing.
- 2 Load the paper in the cassette.

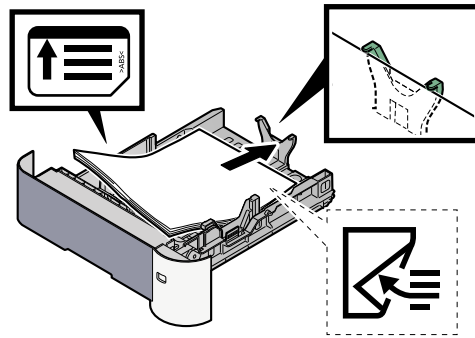

**✔ IMPORTANT**

- Load the paper with the print side facing down.
- After removing new paper from its packaging, fan the paper before loading it in the multi-purpose tray. (Refer to [Precaution for Loading Paper on page 3-13.](#))
- Before loading the paper, be sure that it is not curled or folded. Paper that is curled or folded may cause paper jams.
- Ensure that the loaded paper does not exceed the level indicator (see illustration above).
- If paper is loaded without adjusting the paper length guide and paper width guide, the paper may skew or become jammed.

**5 Gently push the cassette back in.**

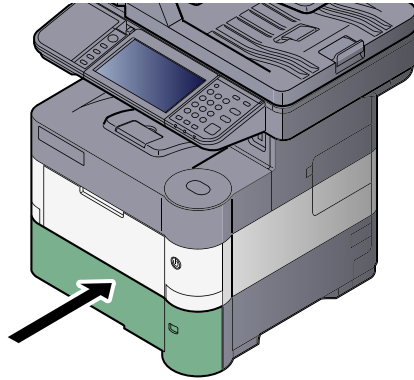

**6 Specify the type of paper loaded in the cassette using the operation panel.**



[Paper Size and Media Type for the Cassettes \(page 3-22\)](#)

## Loading Paper in the Multi Purpose Tray

The multi purpose tray will hold up to 100 sheets of plain paper (80 g/m<sup>2</sup>).

For details of the supported paper sizes, refer to [Choosing the Appropriate Paper on page 11-16](#). For the paper type setting, refer to [Media Type Setting on page 8-14](#). Be sure to use the multi purpose tray when you print on any special paper.

### ✔ IMPORTANT

**If you are using a paper weight of 106 g/m<sup>2</sup> or more, set the media type to Thick and set the weight of the paper you are using.**

The capacity of the multi purpose tray is as follows.

- Plain paper (80 g/m<sup>2</sup>), recycled paper or color paper: 100 sheets
- Thick paper (106 to 220 g/m<sup>2</sup>): 5 sheets
- Hagaki: 1 sheet
- Envelope DL, Envelope C5, Envelope #10 (Commercial #10), Envelope #9 (Commercial #9), Envelope #6 (Commercial #6), Envelope Monarch, Youkei 4, Youkei 2: 5 sheets
- OHP film: 1 sheet

### 💡 NOTE

- When you load custom size paper, enter the paper size by referring to [Paper Size and Media Type for the Multi Purpose Tray \(MP Tray Setting\) on page 3-23](#).
- When you use special paper such as transparencies or thick paper, select the media type by referring to [Paper Size and Media Type for the Multi Purpose Tray \(MP Tray Setting\) on page 3-23](#).

### 1 Open the multi purpose tray.

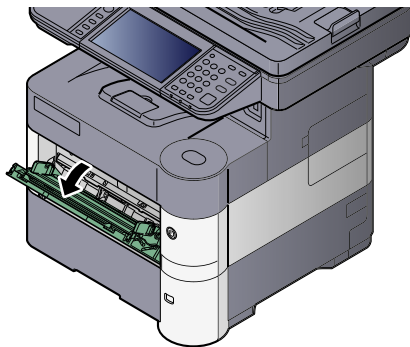

### 2 Pull out the support tray section of the MP tray.

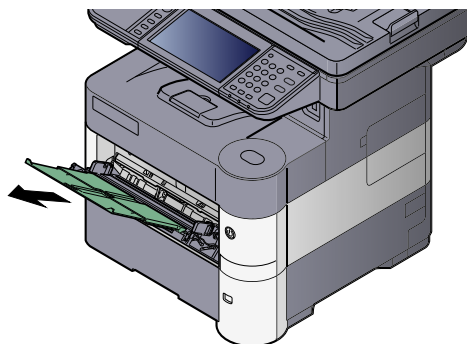

### 3 Adjust the multi purpose tray size.

Paper sizes are marked on the multi purpose tray.

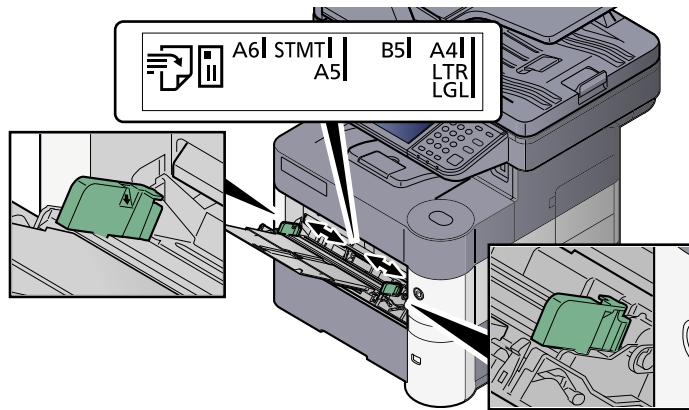

### 4 Load paper.

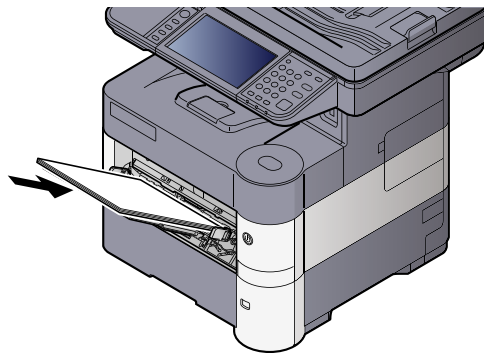

Insert the paper along the paper width guides into the tray until it stops.

After removing new paper from its packaging, fan the paper before loading it in the multi purpose tray.

 [Precaution for Loading Paper \(page 3-13\)](#)

#### IMPORTANT

- When loading the paper, keep the print side facing up.
- Curled paper must be uncurled before use.
- When loading paper into the multi purpose tray, check that there is no paper left over in the tray from a previous job before loading the paper. If there is just a small amount of paper left over in the multi purpose tray and you want to add more, first remove the left-over paper from the tray and include it with the new paper before loading the paper back into the tray.
- If there is a gap between the paper and the paper width guides, readjust the guides to fit the paper in order to prevent skewed feeding and paper jams.
- Ensure that the loaded paper does not exceed the level indicator (see illustration above).

### 5 Specify the type of paper loaded in the multi purpose tray using the operation panel.

 [Paper Size and Media Type for the Multi Purpose Tray \(MP Tray Setting\) \(page 3-23\)](#)

## When you load envelopes or cardstock in the multi purpose tray

### Switching to Envelop Mode (ECOSYS M3040idn/ECOSYS M3540idn)

To print on an envelope, follow the procedure below to switch to envelope mode.



#### NOTE

When the printing on envelopes is completed, return the envelope lever to its original position (at the bottom).

### 1 Open the rear cover.

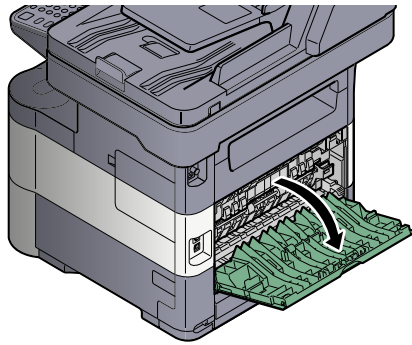

### 2 Raise the envelope lever.

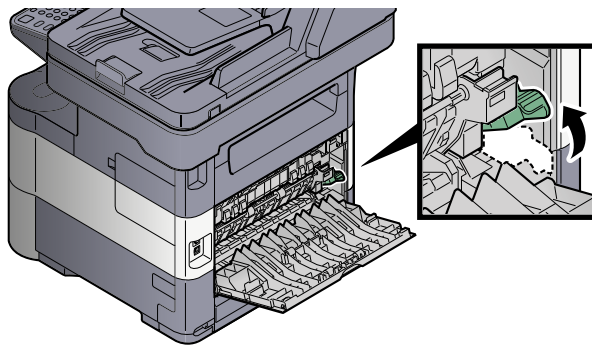

#### CAUTION

The fuser unit inside the machine is hot. Do not touch it with your hands as it may result in burn injury.

### 3 Close the rear cover.

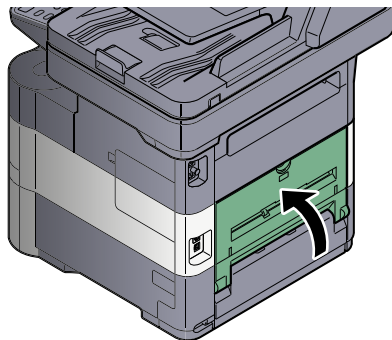

### Loading Envelopes or Cardstock

Load the paper with the print side facing up. For the procedure for printing, refer to the **Printer Driver User Guide**.

Example: When printing the address.

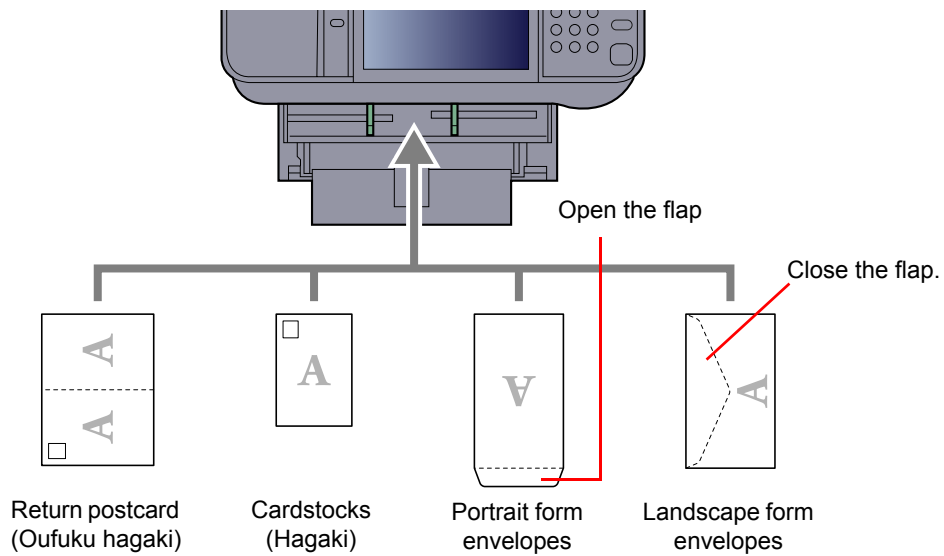

#### ✔ IMPORTANT

- Use unfolded return postcard (Oufuku hagaki).
- How to load envelopes (orientation and facing) will differ depending on the type of envelope. Be sure to load it in correctly, otherwise printing may be done in the wrong direction or on the wrong face.

#### 💡 NOTE

When you load envelopes in the multi purpose tray, select the envelope type by referring to [Paper Size and Media Type for the Multi Purpose Tray \(MP Tray Setting\) on page 3-23](#).

## Specifying Paper Size and Media Type

The default paper size setting for cassette 1, for the multi purpose tray and for the optional paper feeder (cassettes 2 to 5) is "A4" or "Letter", and the default media type setting is "Plain".

To change the type of paper to be used in cassettes, specify the paper size and media type setting.

### Paper Size and Media Type for the Cassettes

Specify the paper size and media type of paper to be used in cassettes.

Selection Item		Selectable Size/Type
Paper Size <sup>*1</sup>	Metric	Select from the Metric standard sizes. <b>Values</b> Cassette 1: A4, A5, A6 <sup>*2</sup> , B5, B6 <sup>*2</sup> , Folio, 216 × 340 mm Cassettes 2 to 5: A4, A5, B6, B5, Folio, 216 × 340 mm
	Inch	Select from the Inch series standard sizes. <b>Values:</b> Letter, Legal, Statement, Executive, Oficio II
	Other	Select from special standard sizes and custom sizes. <b>Values</b> Cassette 1: 16K, ISO B5, Envelope DL <sup>*2</sup> , Envelope C5, Oufuku Hagaki <sup>*2</sup> , Custom <sup>*3</sup> Cassettes 2 to 5: 16K, ISO B5, Envelope #10, Envelope #9, Envelope #6, Envelope Monarch, Envelope DL, Envelope C5, Oufuku Hagaki, Youkei 4, Youkei 2, Custom <sup>*3</sup>
Media type <sup>*4</sup>		Select the media type. <b>Values</b> Cassette 1: Plain (60 - 105 g/m <sup>2</sup> ), Rough, Recycled, Preprinted <sup>*5</sup> , Bond, Color, Prepunched <sup>*5</sup> , Letterhead <sup>*5</sup> , High Quality, Custom 1 - 8 Cassettes 2 to 5: Plain (60 - 105 g/m <sup>2</sup> ), Rough, Recycled, Preprinted <sup>*5</sup> , Bond, Color, Prepunched <sup>*5</sup> , Letterhead <sup>*5</sup> , Envelope, High Quality, Custom 1 - 8

\*1 Only set this when the size dial on the cassette is set to "Other".

\*2 ECOSYS M3550idn/ECOSYS M3560idn only.

\*3 The custom paper sizes are set for each cassette. Refer to [Custom Paper Size on page 8-13](#).

\*4 To change to a media type other than Plain, refer to [Media Type Setting on page 8-14](#). When a paper weight that cannot be loaded in the cassette is set for a media type, that media type does not appear.

\*5 To print on preprinted or prepunched paper or on letterhead, refer to [Special Paper Action on page 8-14](#).



#### NOTE

- The available media types for printing received faxes are as shown below.  
Plain, Recycled, Bond, Color, Envelope, Thick, High Quality, Rough and Custom 1 to 8
- Set the paper size of the cassette used for fax reception as follows:  
Inch models: Letter, Legal, Statement  
Metric models: A4, B5, A5, Folio  
If the above setting is changed, it will not be possible to print faxes.

## Paper Size and Media Type for the Multi Purpose Tray (MP Tray Setting)

Specify the paper size and media type of paper to be used in the multi purpose tray.

Item		Description
Paper Size	Metric	Select from the Metric standard sizes. <b>Values:</b> A4, A5, A6, B5, B6, Folio, 216 × 340 mm
	Inch	Select from the Inch series standard sizes. <b>Values:</b> Letter, Legal, Statement, Executive, Oficio II
	Other	Select from special standard sizes and custom sizes. <b>Values:</b> 16K, ISO B5, Envelope #10, Envelope #9, Envelope #6, Envelope Monarch, Envelope DL, Envelope C5, Hagaki, Oufuku hagaki, Youkei 4, Youkei 2, Custom* <sup>1</sup>
Media Type* <sup>2</sup>		Select the media type. <b>Values:</b> Plain (60 to 105 g/m <sup>2</sup> ), Rough, Transparency, Vellum (60 to 63 g/m <sup>2</sup> ), Labels, Recycled, Preprinted* <sup>3</sup> , Bond, Cardstock, Color, Prepunched* <sup>3</sup> , Letterhead* <sup>3</sup> , Envelope, Thick (106 to 220 g/m <sup>2</sup> ), High Quality, Custom 1-8

\*1 For instructions on how to specify the custom paper size, refer to [Custom Paper Size on page 8-13](#).

\*2 To change to a media type other than "Plain", refer to [Media Type Setting on page 8-14](#).

\*3 To print on preprinted or prepunched paper or on letterhead, refer to [Special Paper Action on page 8-14](#).

### NOTE

- The available media types for printing received faxes are as shown below.  
Plain, Label, Recycled, Bond, Vellum, Color, Envelope, Cardstock, Thick, High Quality, Rough and Custom 1 to 8
- Set the paper size of the cassette used for fax reception as follows:  
Inch models: Letter, Legal, Statement  
Metric models: A4, B5, A5, Folio  
If the above setting is changed, it will not be possible to print faxes.

## 1 Display the screen.

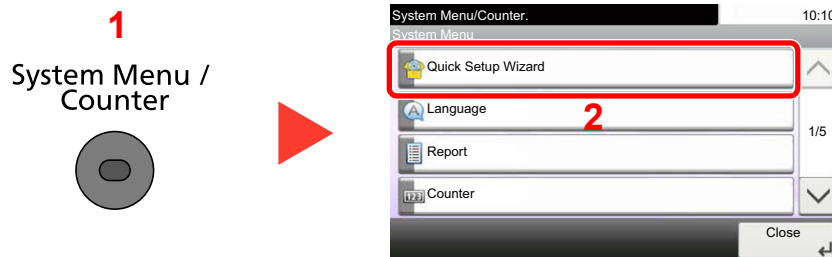

## 2 Select a function.

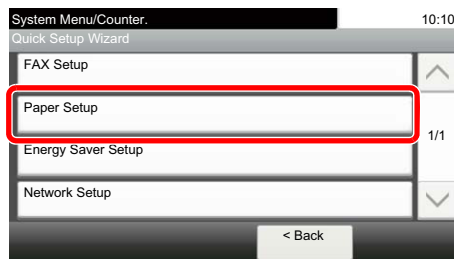



### 3 Configure the function.



Start the wizard. Follow the instructions on the screen to configure settings.

#### **Paper Size and Media Type for the Cassettes:**

If the size dial is set to “A4”, “A5”, “B5”, “Letter”, “Legal” or “A6” (ECOSYS M3550idn/ECOSYS M3560idn cassette 1 only), then set the media type.

If the size dial is set to “Other”, configure the settings for the paper size and the media type.

## Paper Stopper

When using paper large than A4/Letter, open the paper stopper shown in the figure.

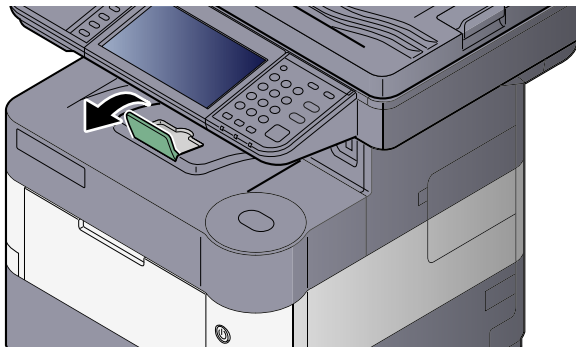

# Preparation for Sending a Document to a Shared Folder in a PC

Check the information that needs to be set on the machine and create a folder to receive the document on your computer. Screens of Windows 7 are used in the following explanation. The details of the screens will vary in other versions of Windows.

## NOTE

Log on to Windows with administrator privileges.

## Making a note of the computer name and full computer name

Check the name of the computer name and full computer name.

### 1 Display the screen.

From [**Start**] button on the Windows, select [**Computer**] and then [**System Properties**].

## NOTE

In Windows XP, right-click [**My Computer**] and select [**Properties**]. The [**System Properties**] dialog box appears. Click the [**Computer Name**] tab in the window that appears.

In Windows 8, select the desktop in the Start screen, right-click [**Computer**] from [**Libraries**], and then select [**Properties**].

In Windows 8.1, select the desktop in the Start screen, right-click [**PC**] from the desktop [**Explorer**] and select [**Properties**]. Or, right-click the Window icon and select [**System**].

### 2 Check the computer name.



Check the computer name and full computer name.

Screen example:

Computer name: PC001

Full computer name: PC001.abcdnet.com

#### Windows XP:

If the full computer name does not have a dot (.), the full computer name and the computer name are the same.

If the full computer name has a dot (.), the text string in front of the dot (.) in the full computer name is the computer name.

Example: PC001.abcdnet.com  
PC001 is the computer name  
PC001.abcdnet.com is the full computer name

After checking the computer name, click the  [**Close**] button to close the "**System Properties**" screen.

In Windows XP, after checking the computer name, click the [**Cancel**] button to close the "**System Properties**" screen.

## Making a note of the user name and domain name

Check the domain name and user name for logging onto Windows.

### 1 Display the screen.

From [Start] button on the Windows, select [All Programs] (or [Programs]), [Accessories] and then [Command Prompt].

In Windows 8, display [Apps] on [Search] in charms on the Start screen, and select [Command Prompt].

The Command Prompt window appears.

### 2 Check the domain name and user name.

At the Command Prompt, enter "net config workstation" and then press [Enter].

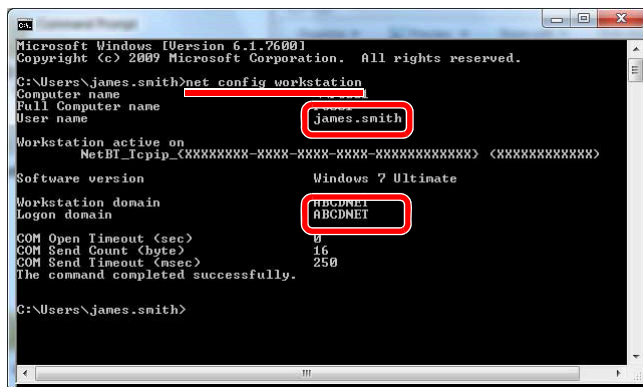

```
Microsoft Windows [Version 6.1.7600]
Copyright (c) 2009 Microsoft Corporation. All rights reserved.

C:\Users\james.smith>net config workstation
Computer name
Full Computer name
User name      james.smith
Workstation active on
NetBI_Tcpip_<XXXXXXXX-XXXX-XXXX-XXXX-XXXXXXXXXXXX> <XXXXXXXXXXXX>
Software version      Windows 7 Ultimate
Workstation domain
Logon domain          ABCDNET
COM Open Timeout (sec)      0
COM Send Count (byte)      16
COM Send Timeout (msec)    250
The command completed successfully.

C:\Users\james.smith>
```

Check the user name and domain name.

Screen example:

User Name: james.smith  
Domain Name: ABCDNET

## Creating a Shared Folder, Making a Note of a Shared Folder

Create a shared folder to receive the document in the destination computer.

### NOTE

If there is a workgroup in System Properties, configure the settings below to limit folder access to a specific user or group.

- 1 From [Start] button on the Windows, select [Control Panel], [Appearance and Personalization], and then [Folder Options].

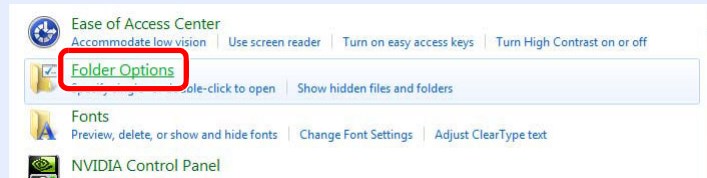

In Windows XP, click [My Computer] and select [Folder Options] in [Tools].

In Windows 8, select [Settings] in charms on Desktop, and select [Control Panel], [Appearance and Personalization], and then [Folder Options].

- 2

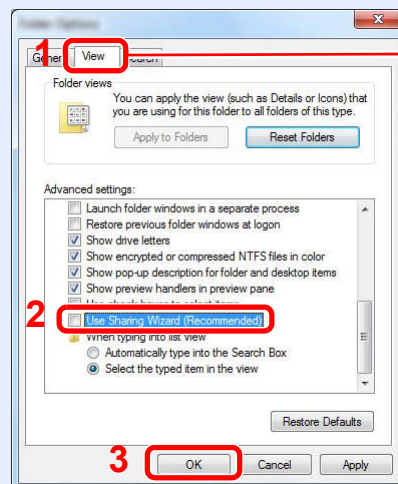

Make sure that the [View] tab is selected.

Remove the checkmark from [Use Sharing Wizard (Recommended)] in "Advanced settings".

In Windows XP, click the [View] tab and remove the checkmark from [Use Simple File Sharing (Recommended)] in "Advanced settings".

## 1 Create a folder.

- 1 Create a folder on your computer.

For example, create a folder with the name "scannerdata" on the desktop.

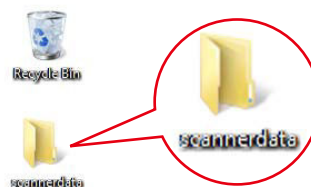

- 2 Right-click the "scannerdata" folder and click **[Share]** and **[Advanced sharing]**. Click the **[Advanced Sharing]** button.

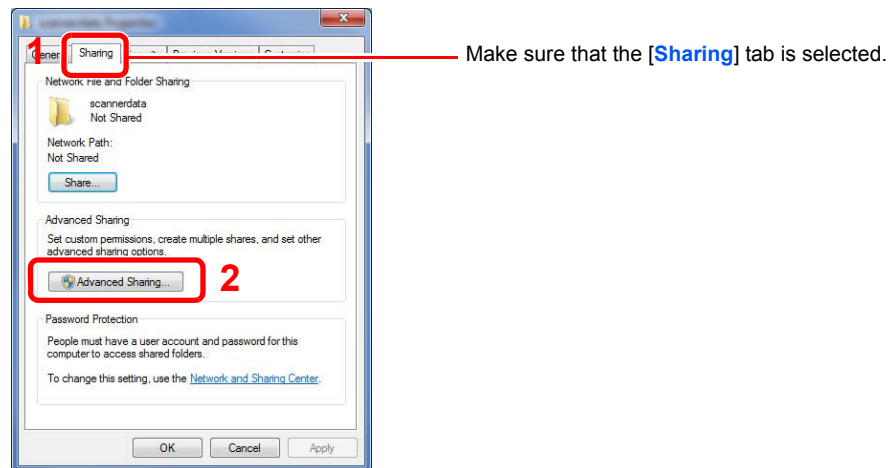

In Windows XP, right-click the "scannerdata" folder and select **[Sharing and Security]** (or **[Sharing]**).

## 2 Configure permission settings.

- 1 Select the **[Share this folder]** checkbox and click the **[Permissions]** button.

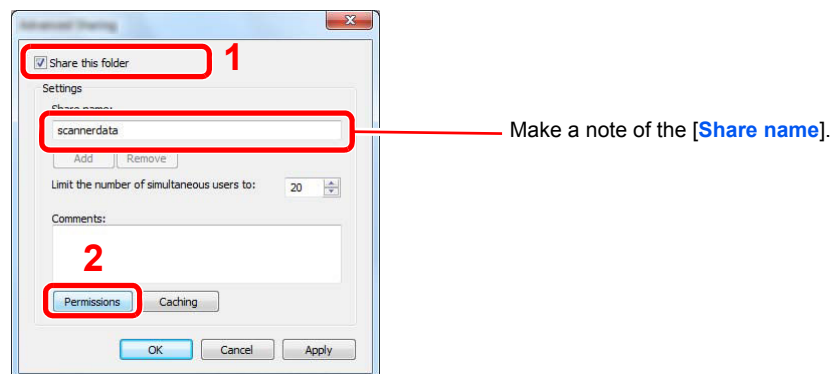

In Windows XP, select **[Share this folder]** and click the **[Permissions]** button.

- 2 Click the **[Add]** button.

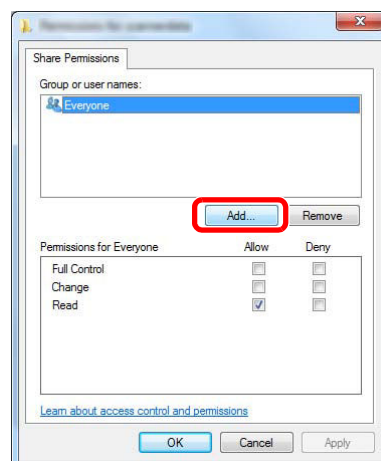

**3** Specify the location.

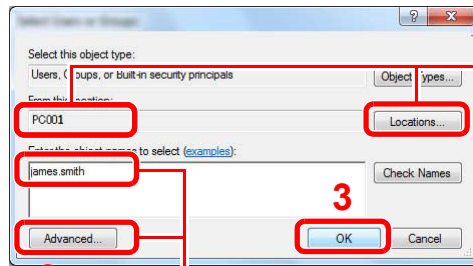

**1** If the computer name that you made a note of on page [Making a note of the computer name and full computer name on page 3-25](#) is the same as the domain name:

If the computer name is not shown in "From this location", click the **[Locations]** button, select the computer name, and click the **[OK]** button.  
Example: PC001

If the computer name that you made a note of on page [Making a note of the computer name and full computer name on page 3-25](#) is not the same as the domain name:

If the text after the first dot (.) in the full computer name that you made a note of does not appear in "From this location", click the **[Locations]** button, select the text after the dot (.), and click the **[OK]** button.

Example: abcdnet.com

**2** Enter the user name that you made a note of on page [Making a note of the user name and domain name on page 3-26](#) in the text box, and click the **[OK]** button.

Also the user name can be made by clicking the **[Advanced]** button and selecting a user.

**4** Set the access permission for the user selected.

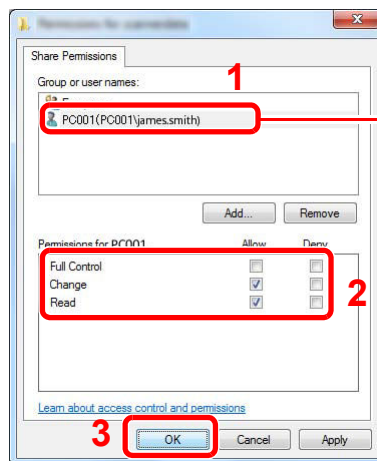

Select the user you entered.

Select the **[Allow]** checkbox of the **"Change"** and **"Read"** permissions and press **[OK]**.

In Windows XP, go to step 6.

**NOTE**

**"Everyone"** gives sharing permission to everyone on the network. To strengthen security, it is recommended that you select **"Everyone"** and remove the **"Read"** **[Allow]** checkmark.

**5** Click the **[OK]** button in the **"Advanced Sharing"** screen to close the screen.

6 Check the details set in the [Security] tab.

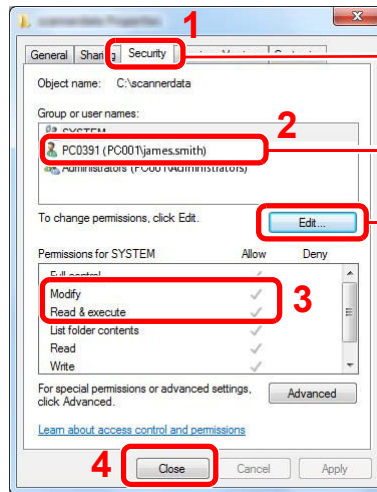

Select the [Security] tab.

Select the user you entered.

If the user does not appear on "Group or user names", click [Edit] button to add user in a similar way of step 2 ([Configure permission settings.](#)).

Make sure that checkmarks appear on [Allow] checkbox for the "Modify" and "Read & execute" permissions, and click the [Close] button.

In Windows XP, make sure that checkmarks appear on [Allow] checkbox for the "Modify" and "Read & execute" permissions, and click the [OK] button.

# Configuring Windows Firewall

Permit sharing of files and printers and set the port used for SMB transmission.

## NOTE

Log on to Windows with administrator privileges.

## 1 Check file and printer sharing.

- 1 From [Start] button on the Windows, select [Control Panel], [System and Security], and [Allow a program through Windows Firewall].

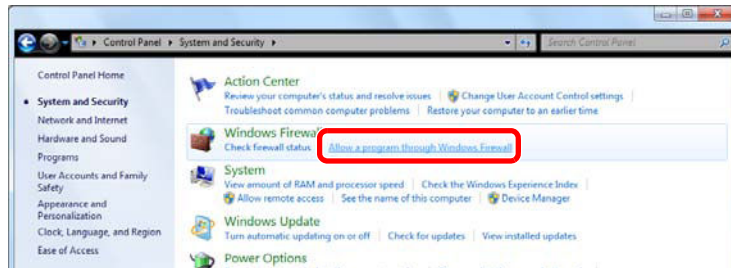

## NOTE

If the User Account Control dialog box appears, click the [Continue] button.

- 2 Select the [File and Printer Sharing] checkbox.

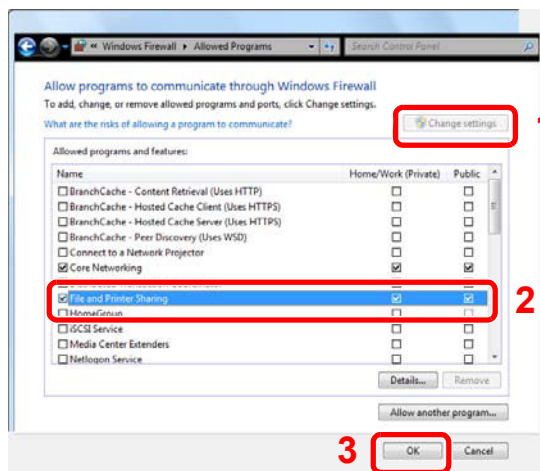

## 2 Add a port.

- 1 From [Start] button on the Windows, select [Control Panel], [System and Security], and [Check firewall status].





2 Select [Advanced settings].



3 Select [Inbound Rules].



4 Select [New Rules].

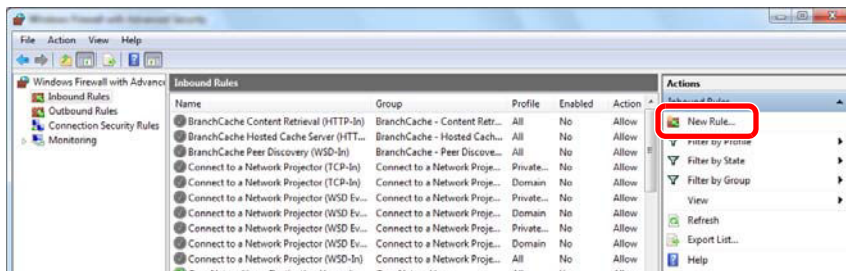

5 Select [Port].

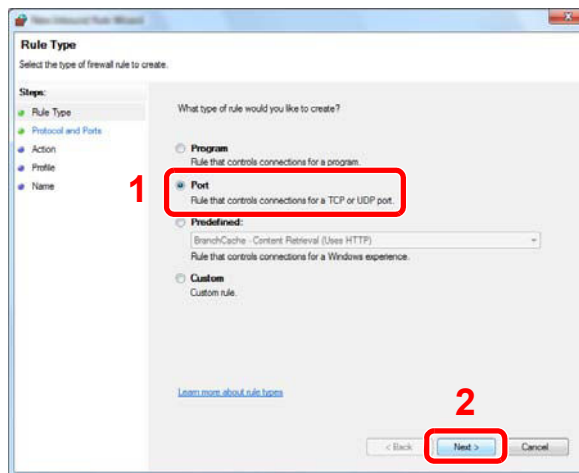

- 6 Select [TCP] as the port to apply the rule to. Then select [**Specific local ports**] and enter "445" then click [**Next**].

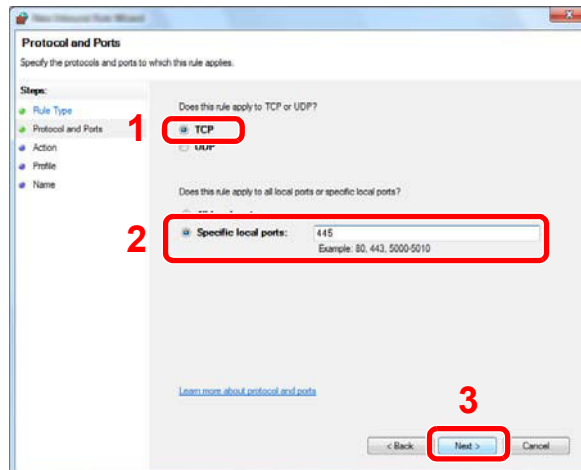

- 7 Select [**Allow the connection**] and click the [**Next**] button.

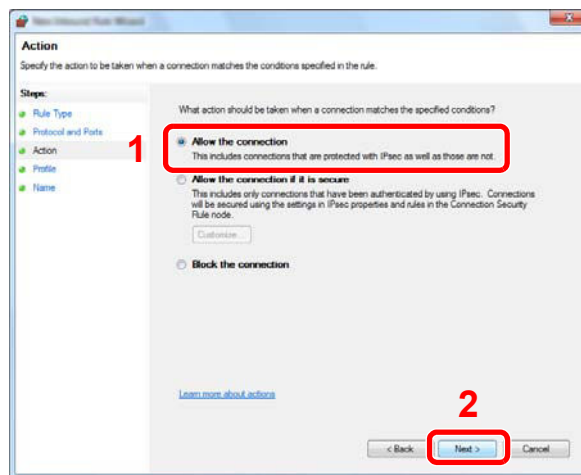

- 8 Make sure all checkboxes are selected and click the [**Next**] button.

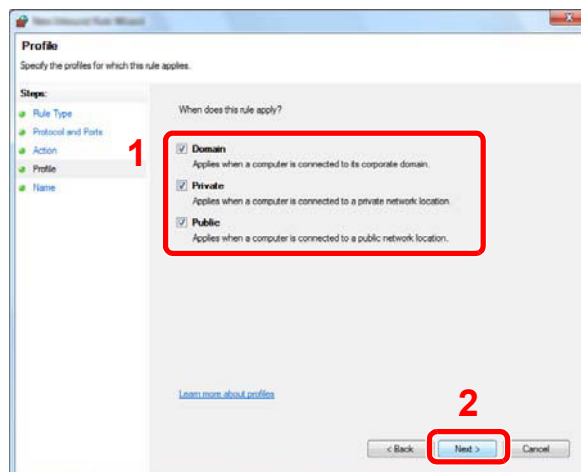

- 9 Enter "Scan to SMB" in "Name" and click [Finish].

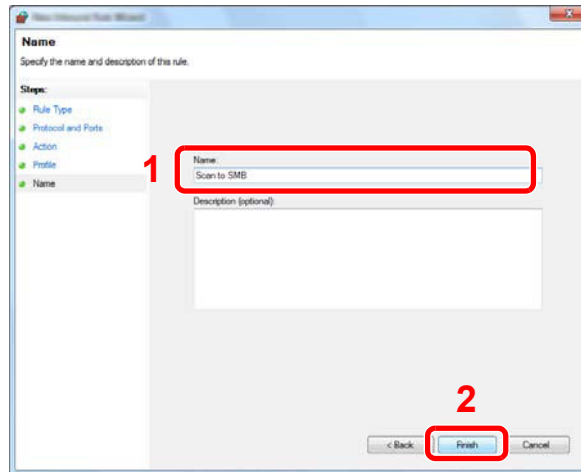

### In Windows XP or Windows Vista

- 1 In Windows XP, from [Start] button on the Windows, select [Control Panel], and then [Windows Firewall].  
In Windows Vista, from [Start] button on the Windows, select [Control Panel], [Security], and then [Turn Windows Firewall on or off].  
If the User Account Control dialog box appears, click the [Continue] button.
- 2 Click the [Exceptions] tab and then the [Add port...] button.
- 3 Specify Add a Port settings.  
Enter any name in "Name" (example: Scan to SMB). This will be the name of the new port.  
Enter "445" in "Port Number". Select [TCP] for "Protocol".
- 4 Click [OK] button.

### In Windows 8

- 1 In charms on Desktop, click [Settings], [Control Panel], [System and Security], and then [Windows Firewall].  
If the User Account Control dialog box appears, click the [Continue] button.
- 2 Configure the settings, refer to [Configuring Windows Firewall on page 3-31](#).

# Registering Destinations in the Address Book

Save frequently used destinations to the Address Book or One Touch Keys. The saved destinations can be changed. The destinations are available for Send as E-mail, Send to Folder, and Fax Transmission (Only on products with the fax function installed).

## NOTE

Registering and editing of the Address Book can also be done in Command Center RX.

 [Registering Destinations \(page 2-45\)](#)

## Adding a Destination (Address Book)

Add a new destination to the Address Book. There are two registering methods, contacts and groups. When adding a group, enter the group name and select group members from the Address Book.

## NOTE

If user login administration is enabled, you can only edit destinations in the Address Book by logging in with administrator privileges.

### Contact

A maximum of 200 contact addresses can be registered. Each address can include the information such as destination name, E-mail address, FTP server folder path, computer folder path, and FAX No. (Only on products with the fax function installed).

## 1 Display the screen.

- 1 Press the **[System Menu/Counter]** key.

System Menu /  
Counter



- 2 Press **[∨]**, **[Address Book/One Touch]**, **[Address Book]**, **[+]**, and then **[Contact]**.

## 2 Add the name.

Enter the destination name (up to 32 characters) to be displayed on the Address Book and press **[Next]**.

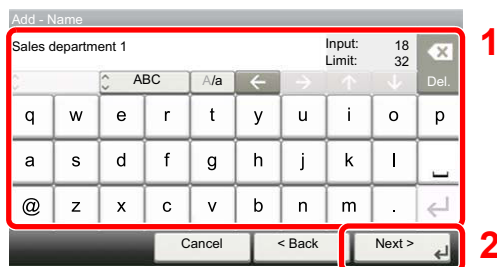

The screenshot shows the 'Add - Name' screen. At the top, it says 'Add - Name' and 'Sales department 1'. To the right, it shows 'Input: 18' and 'Limit: 32'. Below this is a numeric keypad with letters. A red box highlights the entire keypad area, labeled with a red '1'. At the bottom of the keypad, there are three buttons: 'Cancel', '< Back', and 'Next >'. A red box highlights the 'Next >' button, labeled with a red '2'.

## NOTE

Refer to the [Character Entry Method on page 11-12](#) for details on entering characters.

### 3 Add the address.

- 1 Press [E-mail Address] to add an E-mail address, [SMB] to add a folder on the PC, or [FTP] to add an FTP folder.

The procedure differs depending on the transmission method selected.

#### E-mail Address

Enter the E-mail address and press [OK].



#### NOTE

Refer to the [Character Entry Method on page 11-12](#) for details on entering characters.

#### The Folder (SMB) Address

Press [Host Name], [Path], [Port], [Login User Name] and [Login Password], enter the information for each item and press [OK].

The table below explains the items to be entered.



#### NOTE

For the computer name, share name, domain name, and user name, enter the information that you noted when you created the shared folder. For details on creating shared folders, refer to [Preparation for Sending a Document to a Shared Folder in a PC on page 3-25](#).

Item	Description	Max. No. of Characters
<b>Host Name</b>	Computer name	Up to 64 characters
<b>Path</b>	Share name For example: scannerdata If saving in a folder in the shared folder: share name\folder name in shared folder	Up to 128 characters
<b>Port</b>	Port number (Normally 445.)	1 - 65535
<b>Login User Name</b>	If the computer name and domain name are the same: User Name For example: james.smith If the computer name and domain name are different: Domain name\User name For example: abcdnet\james.smith	Up to 64 characters
<b>Login Password</b>	Windows logon password (Case sensitive.)	Up to 64 characters

To search for a folder on a PC on the network, press [Menu] and then [Search Folder from Network] or [Search Folder by Host Name].

If you selected [Search Folder from Network], you can enter the "Domain/Workgroup", and "Host Name" to search PCs on the network for the destination.

If you pressed [Search Folder by Host Name], you can search all PCs on the network for a destination.

A maximum of 500 addresses can be displayed. Select the host name (PC name) that you want to specify in the screen that appears, and press [Next]. The login user name and login password entry screen appears.

**NOTE**

- Refer to the [Character Entry Method on page 11-12](#) for details on entering characters.
- Press [Menu] and then [Connection Test] to check the connection to the server you chose. If the connection fails, check the entries you made.

**The Folder (FTP) Address**

Press [Change] of "Host Name", "Path", "Login User Name" and "Login Password", enter the information for each item and press [OK].

The table below explains the items to be entered.

Item	Descriptions	Max. No. of Characters
<b>Host Name</b>	Host name or IP address of FTP server	Up to 64 characters
<b>Path*1</b>	Path for the file to be stored For example: User\ScanData If no path is entered, the file is stored in the home directory.	Up to 128 characters
<b>Port</b>	Port number (Normally 21.)	1 - 65535
<b>Login User Name</b>	FTP server login user name	Up to 64 characters
<b>Login Password</b>	FTP server login password	Up to 64 characters

\*1 When the FTP server is based on Linux/UNIX, the path including the sub-folder is combined by the slash "/" not using the back-slash.

**NOTE**

- Refer to the [Character Entry Method on page 11-12](#) for details on entering characters.
- Press [Menu] and then [Connection Test] to check the connection to the FTP server you chose. If the connection fails, check the entries you made.

**2** To specify the Address Number, press [Address Number].

- 3 Use [+] / [-] or the numeric keys to enter an address number (001 to 250).

To have the number assigned automatically, enter "000".

 **NOTE**

- Address Number is an ID for a destination. You can select any available number out of 200 numbers for contacts and 50 numbers for groups.
- If you specify an address number that is already in use, an error message appears when you press [Save] and the number cannot be registered. If you set "000" as the address number, the address is registered under the lowest available number.

- 4 Press [OK].
- 5 Check if the destination entry is correct and press [Save]. The destination is added to the Address Book.

## Group

Compile two or more contacts into a group. Designations in the group can be added at the same time. When adding a group, a maximum of 50 groups can be added in the Address Book.

 **NOTE**

To add a group, you need individually added destinations. Register one or more individual destinations as needed before proceeding. Up to 100 individually registered destinations and a combined total of up to 5 SMB and FTP destination folders can be registered in a single group.

### 1 Display the screen.

- 1 Press the [System Menu/Counter] key.

System Menu /  
Counter



- 2 Press [∨], [Address Book/One Touch], [Address Book], [+], and then [Group].

### 2 Add the name.

Enter the group name (up to 32 characters) to be displayed on the Address Book and press [Next].

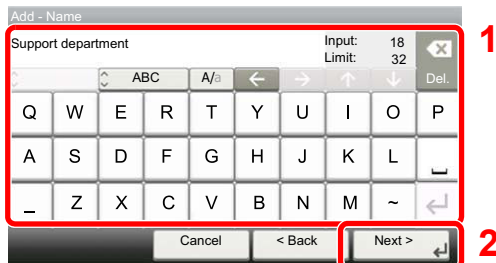

 **NOTE**

Refer to the [Character Entry Method on page 11-12](#) for details on entering characters.

### 3 Select the members (destinations).

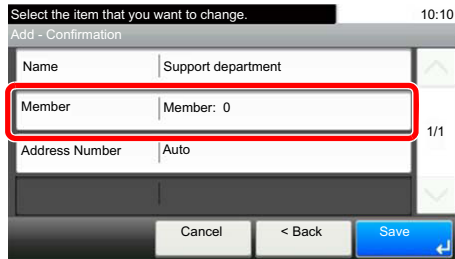

- 1 Press [Member].
- 2 Press [+].
- 3 Select destinations (contacts) to add to the group. The selected destinations are indicated by a checkmark in the check box.

#### NOTE

Destinations can be sorted or searched by destination name or address number. For details, refer to [Specifying Destination on page 5-22](#).

- 4 Press [OK].  
If you have more destinations to add, repeat Steps 3-2 to 3-4.
- 5 Press [End].
- 6 To specify the Address Number, press [Address Number].
- 7 Use [+] / [-] or the numeric keys to enter an address number (001 to 250).  
To have the number assigned automatically, enter "000".

#### NOTE

- Address Number is an ID for a destination. You can select any available number out of 200 numbers for contacts and 50 numbers for groups.
- If you specify an address number that is already in use, an error message appears when you press [Save] and the number cannot be registered. If you set "000" as the address number, the address is registered under the lowest available number.

- 8 Press [OK].
- 9 Check if the selected destination was added to the group and press [Save]. The group is added to the Address Book.

## Editing and Deleting Address Book Entries

Edit and delete the destinations (contacts) you added to the Address Book.

### 1 Display the screen.

- 1 Press the [System Menu/Counter] key.

System Menu /  
Counter





- 2 Press [, [Address Book/One Touch] and then [Address Book].

The procedure differs depending on the details to be edited.

## 2 Edit or delete the destination.





### NOTE

Destinations can be sorted or searched by destination name or address number. For details, refer to [Specifying Destination on page 5-22](#).

### Editing a Contact

- 1 Press [] for the destination (contacts) to edit.
- 2 Change [Name], [Address Number] and destination type and address. Refer to [Contact on page 3-35](#) for the details.
- 3 After you have completed the changes, press [Save].
- 4 Press [Yes] in the change confirmation screen to register the changed destination.

### Editing a Group

- 1 Press [] for the group to edit.
- 2 Change [Name] and [Address Number]. Refer to [Group on page 3-38](#) for the details.
- 3 Press [Member].
- 4 To delete any destination from the group, select the destination and press []. Press [Yes] on the screen to confirm the deletion.  
To add the destination, press [].
- 5 After you have completed the changes, press [Save].
- 6 Press [Yes] in the change confirmation screen to register the changed group.

### Deleting a Contact or Group

Select a destination or group to delete and press []. Press [Yes] on the screen to confirm the deletion.

# Adding a Destination on One Touch Key (One Touch Key)

Assign a new destination (contact or group) to an one touch key. A maximum of 100 destinations can be registered.

## NOTE

- Refer to [Specifying Destination on page 5-22](#) for use of One Touch Key.
- You can add One Touch keys and change their settings on Command Center RX.

 [Registering Destinations \(page 2-45\)](#)

## 1 Display the screen.

- 1 Press the [System Menu/Counter] key.

System Menu /  
Counter



- 2 Press [∨], [Address Book/One Touch] and then [One Touch Key].

## 2 Add One Touch Keys.

- 1 Select a One Touch Key number (001 to 100) for the destination, and press [+]. Pressing the [Quick No. Search] key enables direct entry of a One Touch Key number.

Select a One Touch Key with no registered destination.

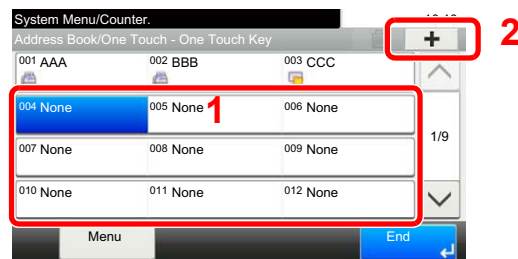

- 2 Select a destination (contact or group) to add to the One Touch Key number, and press [Next].

Pressing [☎] shows the detailed information of the selected destination.

## NOTE

Destinations can be sorted or searched by destination name or address number. For details, refer to [Specifying Destination on page 5-22](#).

- 3 Enter the One Touch Key name (up to 24 characters) displayed in the send base screen, and press [Next].

## NOTE

Refer to the [Character Entry Method on page 11-12](#) for details on entering characters.

- 4 Press [Save].

The destination will be added to the One Touch Key.

## Editing and Deleting One Touch Key

Edit and delete the destinations you added to One Touch Key.

### 1 Display the screen.

- 1 Press the [System Menu/Counter] key.

System Menu /  
Counter



- 2 Press [ √ ], [Address Book/One Touch] and then [One Touch Key].
- 3 Select a One Touch Key number (001 to 100) for the destination. Pressing the [Quick No. Search] key enables direct entry of a One Touch Key number.

The procedure differs depending on the details to be edited.

### 2 Edit and delete the destinations you added to One Touch Key.

#### Changing the Registered Information

- 1 Press [Menu], [Edit] and then [Destination].
- 2 Select a new destination (contact or group). Pressing [ ] shows the detailed information of the selected destination.



#### NOTE

Destinations can be sorted or searched by destination name or address number. For details, refer to [Specifying Destination on page 5-22](#).

- 3 Press [OK].
- 4 Press [Yes] on the screen to add the destination to the One Touch Key.

#### Deleting the Registered Information

- 1 Press [ ].

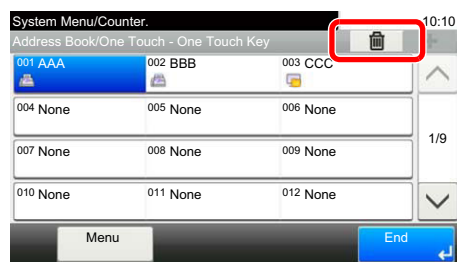

- 2 Press [Yes] on the screen to confirm the deletion of the data registered in the One Touch Key.

# 4 Printing from PC

This chapter explains the following topics:

Printing from PC .....	4-2
Printing on Non-standard Sized Paper .....	4-4
Printer Driver Print Settings Screen .....	4-5
Printer Driver Help .....	4-6
Changing the Default Printer Driver Settings (Windows 7) .....	4-6
Canceling Printing from a Computer .....	4-6
Printing by AirPrint .....	4-7
Printing Data Saved on the Printer .....	4-8
Specifying the Job Box from a Computer and Storing the Job .....	4-8
Printing Documents from Private Print Box .....	4-8
Printing Document from Stored Job Box .....	4-11
Printing Document from Quick Copy Box .....	4-14
Printing Document from Proof and Hold Box .....	4-17

# Printing from PC

Follow the steps below to print documents from applications.

This section provides the printing method using the KX DRIVER.

## NOTE

- To print the document from applications, install the printer driver on your computer from the supplied DVD (Product Library).
- In some environments, the current settings are displayed at the bottom of the printer driver.

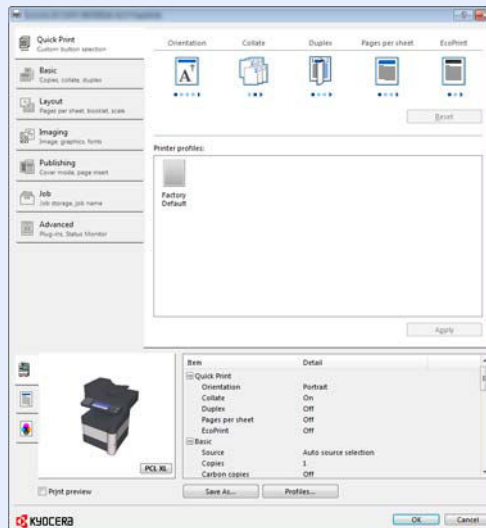

- When printing the cardstock or envelopes, load the cardstock or envelopes before performing the following procedure. (Refer to [When you load envelopes or cardstock in the multi purpose tray on page 3-20.](#))

## 1 Display the screen.

Click [File] and select [Print] in the application.

## 2 Configure the settings.

- 1 Select the machine from the "Name" menu and click the [Properties] button.

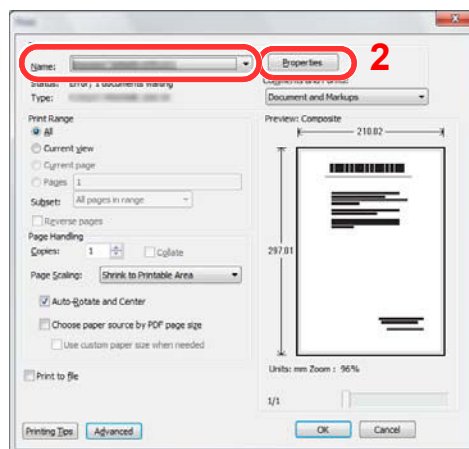

2 Select the [Basic] tab.

3 Click "Print size" menu and select the paper size to use for printing.

To load the paper of size that is not included in print sizes of the machine such as cardstock or envelopes, the paper size needs to be registered.

 [Printing on Non-standard Sized Paper \(page 4-4\)](#)

To print on the special paper such as thick paper or transparency, click "Media type" menu and select the media type.

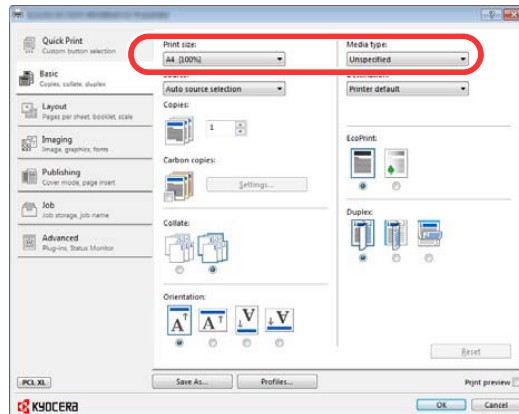

4 Click [OK] button to return to the Print dialog box.

### 3 Start printing.

Click the [OK] button.

## Printing on Non-standard Sized Paper

If you loaded a paper size that is not included in the print sizes of the machine, register the paper size in the [Basic] tab of the print settings screen of the printer driver.

The registered size can be selected from the "Print size" menu.

### NOTE

To execute printing at the machine, set the paper size and type in [Paper Size and Media Type for the Multi Purpose Tray \(MP Tray Setting\) on page 3-23](#).

## 1 Display the print settings screen.

## 2 Register the paper size.

- 1 Click the [Basic] tab.
- 2 Select [Custom] in the "Print size" menu.
- 3 Click the [New] button.
- 4 Enter the name of the paper.
- 5 Enter the paper size.
- 6 Click the [OK] button.
- 7 In the "Print size" menu, select the paper size (name) that you registered in steps 4 to 7.
- 8 Click [MP tray] in the "Source" menu.
- 9 Select the type of paper in the "Media type" menu.

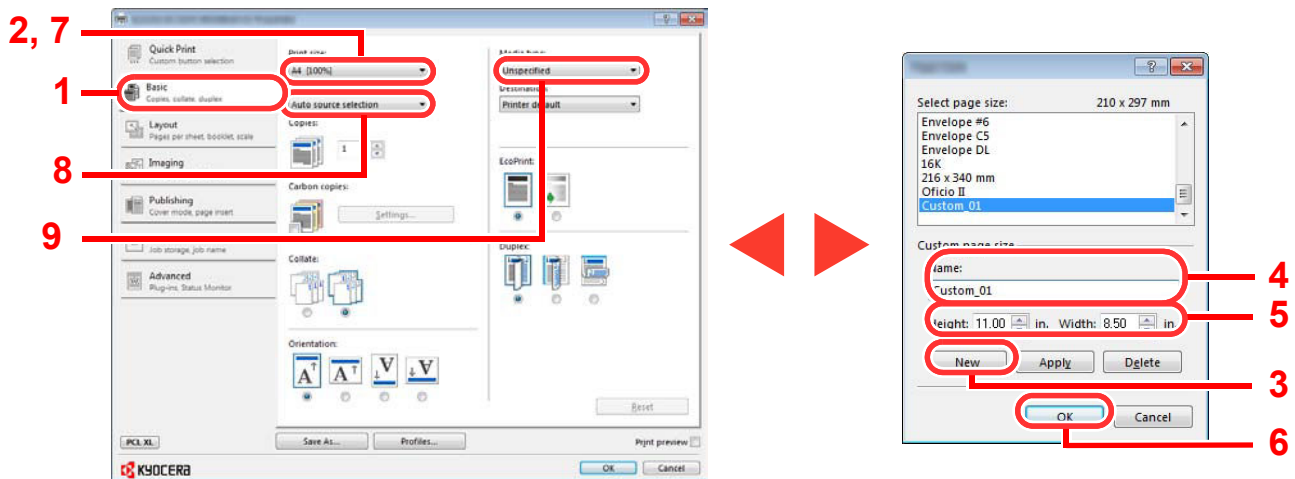

### NOTE

If you loaded a postcard or envelope, select [Cardstock] or [Envelope] in the "Media type" menu.

## Printer Driver Print Settings Screen

The printer driver print settings screen allows you to configure a variety of print-related settings. For more information, refer to the **Printer Driver User Guide** on the DVD.

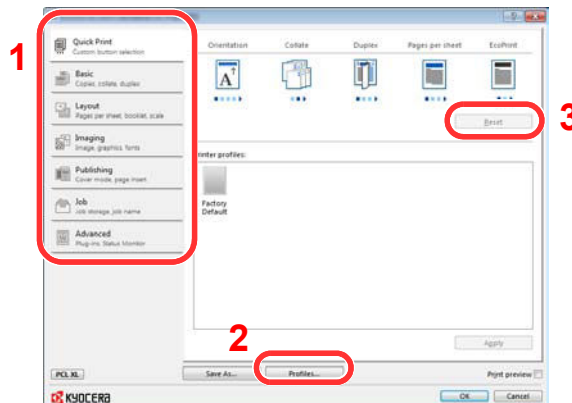

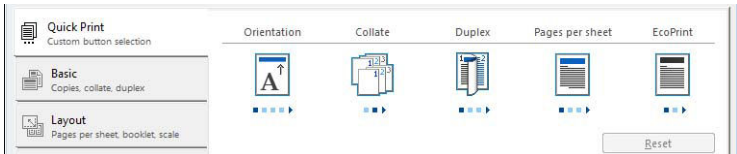
No.	Description
1	<p><b>[Quick Print] tab</b> Provides icons that can be used to easily configure frequently used functions. Each time you click an icon, it changes to an image resembling the print results and applies the settings.</p>  <p><b>[Basic] tab</b> Copies, collate, duplex</p> <p><b>[Layout] tab</b> Pages per sheet, booklet, scale</p> <p><b>[Imaging] tab</b> This tab lets you configure settings related to the quality of the print results.</p> <p><b>[Publishing] tab</b> This tab lets you create covers and inserts for print jobs and put inserts between sheets of OHP film.</p> <p><b>[Job] tab</b> This tab lets you configure settings for saving print data from the computer to the machine. Regularly used documents and other data can be saved to the machine for easy printing later. Since saved documents can be printed directly from the machine, this function is also convenient when you wish to print a document that you don't want others to see.</p> <p><b>[Advanced] tab</b> This tab lets you configure settings for adding text pages or watermarks to print data.</p>
2	<p><b>[Profiles]</b> Printer driver settings can be saved as a profile. Saved profiles can be recalled at any time, so it's a convenient practice to save frequently used settings.</p>
3	<p><b>[Reset]</b> Click to revert settings to their initial values.</p>



## Printer Driver Help

The printer driver includes Help. To learn about print settings, open the printer driver print settings screen and display Help as explained below.

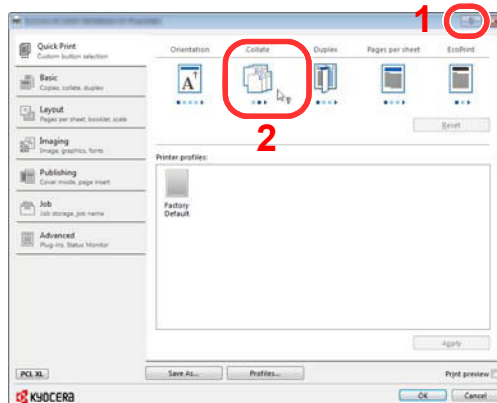

- Click the [?] button in the upper right corner of the screen and then click the item you want to know about.
- Click the item you want to know about and press the [F1] key on your keyboard.

## Changing the Default Printer Driver Settings (Windows 7)

The default printer driver settings can be changed. By selecting frequently used settings, you can omit steps when printing. For the settings, refer to **Printer Driver User Guide**.

- 1 Click [Start] button on the Windows, and then click [Devices and Printers].
- 2 Right-click the printer driver icon of the machine, and click the [Printer properties] menu of the printer driver.
- 3 Click the [Basic] button on the [General] tab.
- 4 Select the default settings and click the [OK] button.

## Canceling Printing from a Computer

To cancel a print job executed using the printer driver before the printer begins printing, do the following:



### NOTE

When canceling printing from this machine, refer to [Canceling Jobs on page 5-18](#).

- 1 Double-click the printer icon (  ) displayed on the taskbar at the bottom right of the Windows desktop to display a dialog box for the printer.
- 2 Click the file for which you wish to cancel printing and select [Cancel] from the "Document" menu.

## Printing by AirPrint

AirPrint is a printing function that is included standard in iOS 4.2 and later products, and Mac OS X 10.7 and later products.

This function enables you to connect and print to any AirPrint compatible device without installing a printer driver.

To allow the machine to be found when printing by AirPrint, you can set machine location information in Command Center RX.

For details, refer to the **Command Center RX User Guide**.



## Printing Data Saved on the Printer

If you configure settings in the [Job] tab of the printer driver and then print, the print job will be saved in the Job Box (memory) and printing can be executed at the machine.

Follow the work flow below when using Job Box.

Specifying the Job Box from a computer and sending the print job. ([page 4-8](#))



Using the operation panel to specify a file within a Box and printing it.

You can print the documents from the following boxes.

- Private Print Box ([page 4-8](#))
- Stored Job Box ([page 4-11](#))
- Quick Copy Box ([page 4-14](#))
- Proof-and-Hold Box ([page 4-17](#))

## Specifying the Job Box from a Computer and Storing the Job

Use the procedure below to store data in a Job Box.

- 1 Click [File] and select [Print] in the application. The Print dialog box displays.
- 2 Select the machine from the "Name" menu.
- 3 Click the [Properties] button. The Properties dialog box displays.
- 4 Click the [Job] tab and select the [Job storage (e-MPS)] check box to set the function.



### NOTE

- To use Stored Job Box and Quick Copy Box, an optional SSD must be installed in the machine.
- For information on how to use the printer driver software, refer to the **Printer Driver User Guide**.

## Printing Documents from Private Print Box

In Private Printing, you can specify that a job is not to be printed until you operate the machine. When sending the job from the application software, specify a 4-digit access code in the printer driver. The job is released for printing by entering the access code on the operation panel, ensuring confidentiality of the print job. The data will be deleted upon completion of the print job or after the power switch is turned off.

The following operations are possible:

- Printing the Documents ([page 4-9](#))
- Deleting the Documents ([page 4-10](#))

## Printing the Documents

Print the documents stored in a Private Print box. The procedure is as follows.

### 1 Display the screen.

- 1 Press [Job Box] in the home screen.

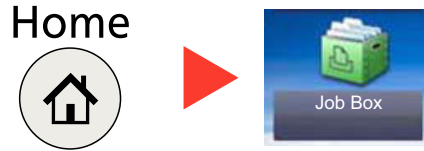

- 2 Select [Private Print/Stored Job].

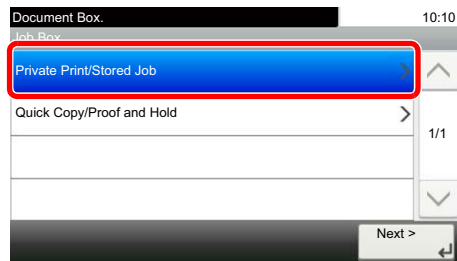

- 3 Select the creator of the document.



### 2 Print the document.

- 1 Select the document to print and press [Print].

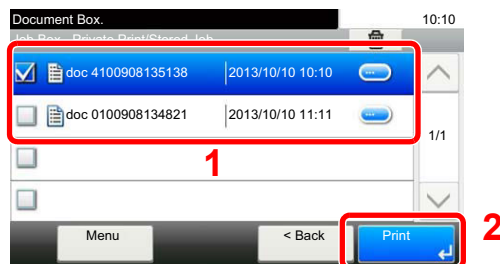

- 2 Specify the number of copies to print as desired.

- 3 Press [OK].

Printing starts.

Upon completion of printing, the Private Print job is automatically deleted.

#### NOTE

If the document is protected by an access code, the password entry screen will be displayed. Enter the password using the numeric keys.

## Deleting the Documents

Delete the documents stored in a Private Print box. The procedure is as follows.

### 1 Display the screen.

- 1 Press [Job Box] in the home screen.

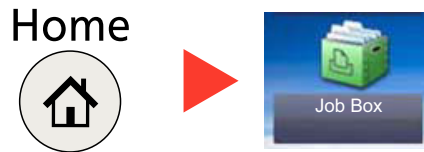

- 2 Select [Private Print/Stored Job].

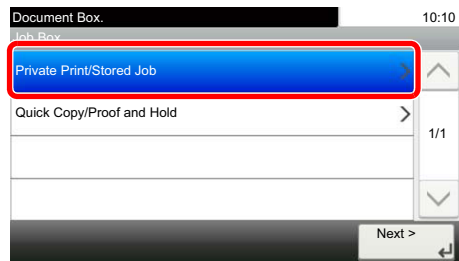

- 3 Select the creator of the document.



### 2 Delete the document.

- 1 Select the document to delete and press [🗑️].

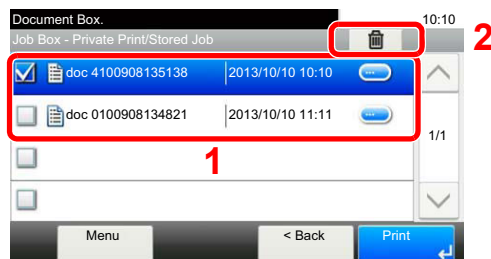

- 2 Press [Yes] in the confirmation screen.

The document is deleted.

#### NOTE

If the document is protected by an access code, the password entry screen will be displayed. Enter the password using the numeric keys.

## Printing Document from Stored Job Box

In Stored Job, the print data sent from the application is saved to the machine. You can set up an access code as necessary. If you set up an access code, enter the access code when printing. Print data will be stored in the Stored Job Box after printing. This will allow printing of the same print data repeatedly.

The following operations are possible:

- Printing the Documents ([page 4-11](#))
- Deleting the Documents ([page 4-12](#))

### Printing the Documents

Print the documents stored in a Stored Job box. The procedure is as follows.

#### 1 Display the screen.

- 1 Press [Job Box] in the home screen.

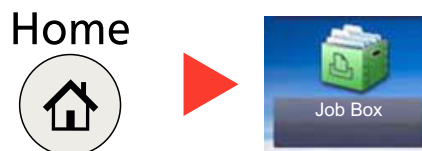

- 2 Select [Private Print/Stored Job].

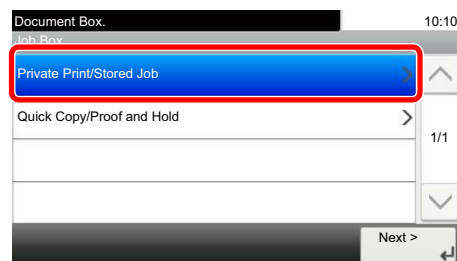

- 3 Select the creator of the document.



#### 2 Print the document.

- 1 Select the document to print and press [Print].

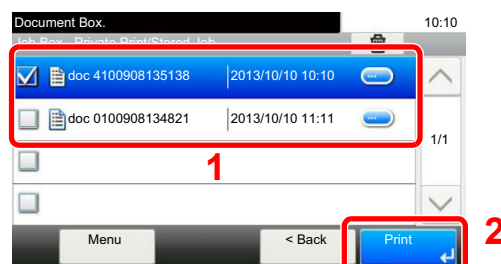

- 2 Specify the number of copies to print as desired.
- 3 Press [OK].  
Printing starts.

 **NOTE**

If the document is protected by an access code, the password entry screen will be displayed. Enter the password using the numeric keys.

## Deleting the Documents

Delete the documents stored in a Stored Job box. The procedure is as follows.

### 1 Display the screen.

- 1 Press [Job Box] in the home screen.

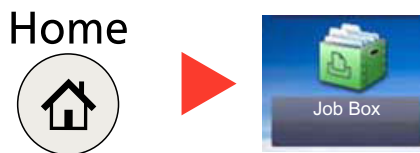

- 2 Select [Private Print/Stored Job].

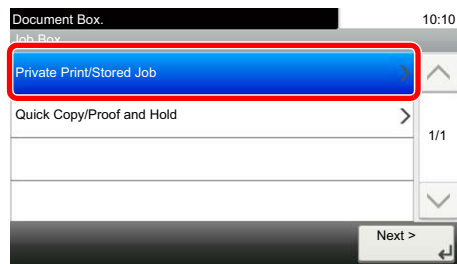

- 3 Select the creator of the document.

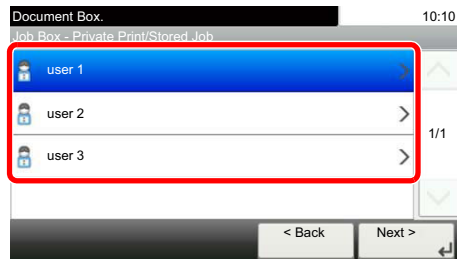

### 2 Print and delete the document.

- 1 Select the document to delete and press [  ].

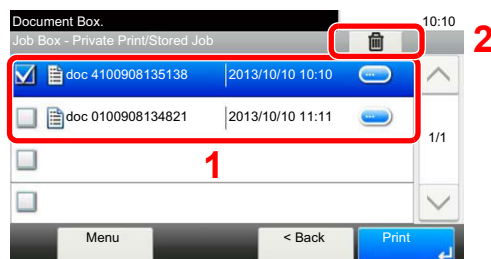

- 2 Press [Yes] in the confirmation screen.

The document is deleted.



**NOTE**

If the document is protected by an access code, the password entry screen will be displayed. Enter the password using the numeric keys.



## Printing Document from Quick Copy Box

Quick Copy feature facilitates additional prints of a document already printed. Activating Quick Copy and printing a document using the printer driver allow the print data to be stored in the Quick Copy Job Box. When additional copies are required, you can reprint the required number of copies from the operation panel. By default, up to 32 documents can be stored. When power is turned off, all stored jobs will be deleted.

### NOTE

- When the number of jobs reaches the limit, the oldest job will be overwritten by the new one.
- To maintain free space on the box, you can set the maximum number of stored jobs. For details, refer to [Quick Copy Job Retention on page 8-22](#).

The following operations are possible:

- Printing the Documents ([page 4-14](#))
- Deleting the Documents ([page 4-15](#))

### Printing the Documents

You can print the documents stored in the Quick Copy box. The procedure is as follows.

#### 1 Display the screen.

- 1 Press [Job Box] in the home screen.

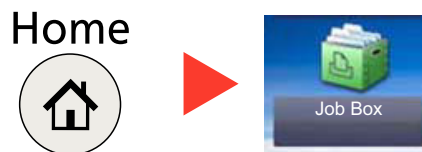

- 2 Select [Quick Copy/Proof and Hold].

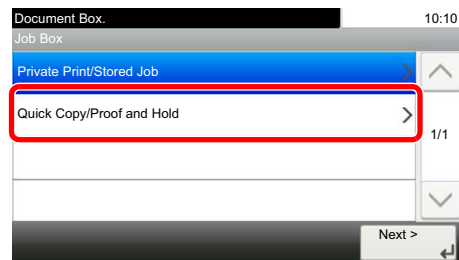

- 3 Select the creator of the document.

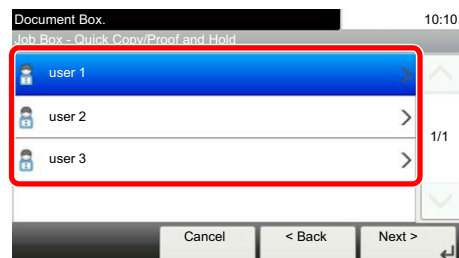

## 2 Print the document.

- 1 Select the document to print and press [Print].

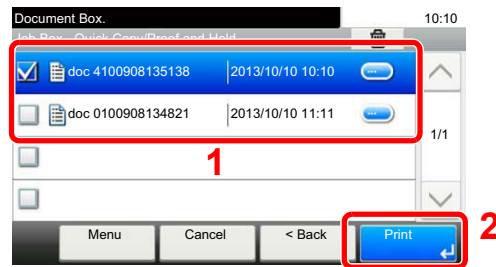

- 2 Specify the number of copies to print as desired.
- 3 Press [OK].  
Printing starts.

## Deleting the Documents

You can delete the documents stored in the Quick Copy box. The procedure is as follows.

### 1 Display the screen.

- 1 Press [Job Box] in the home screen.

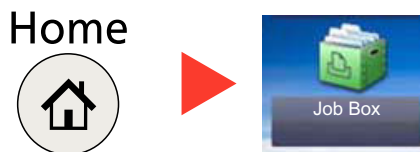

- 2 Select [Quick Copy/Proof and Hold].



- 3 Select the creator of the document.

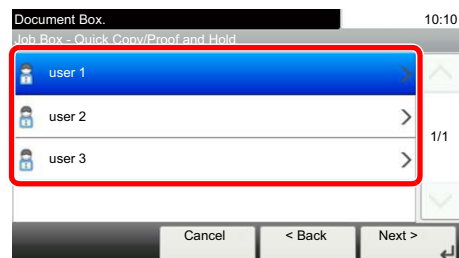

## 2 Delete the document.

- 1 Select the document to delete and press [  ].

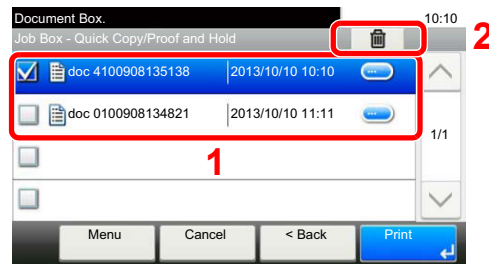

- 2 Press [Yes] in the confirmation screen.  
The document is deleted.

## Printing Document from Proof and Hold Box

The Proof and Hold feature produces only a single proof print of multiple-print job and holds printing of the remaining copies. Printing a multiple-print job in Proof and Hold using the printer driver allows only a single copy to be printed while maintaining the document data in the Job Box. To continue to print the remaining copies, use the operation panel. You can change the number of copies to print.

The following operations are possible:

- Printing the Documents ([page 4-17](#))
- Deleting the Documents ([page 4-18](#))

### Printing the Documents

You can print the documents stored in the Proof and Hold box. The procedure is as follows.

#### 1 Display the screen.

- 1 Press [Job Box] in the home screen.

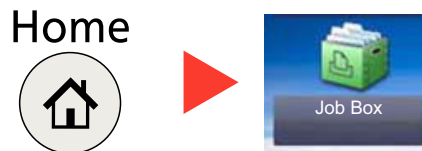

- 2 Select [Quick Copy/Proof and Hold].

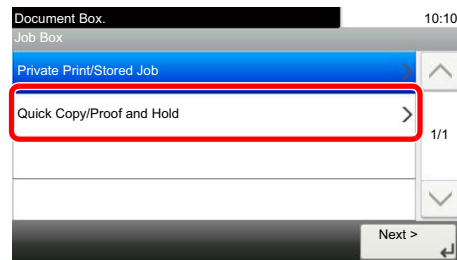

- 3 Select the creator of the document.



## 2 Print the document.

- 1 Select the document to print and press [Print].

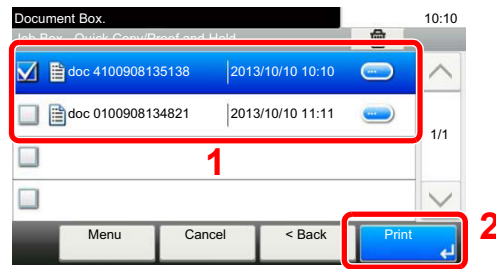

- 2 Specify the number of copies to print as desired.
- 3 Press [OK].  
Printing starts.

## Deleting the Documents

You can delete the documents stored in the Proof and Hold box. The procedure is as follows.

### 1 Display the screen.

- 1 Press [Job Box] in the home screen.

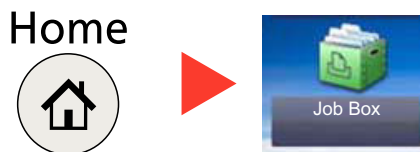

- 2 Select [Quick Copy/Proof and Hold].

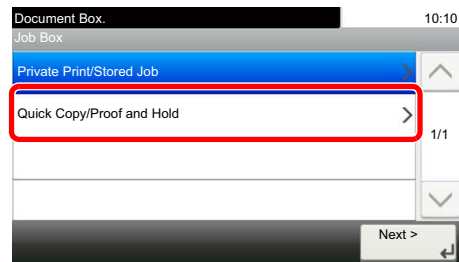

- 3 Select the creator of the document.

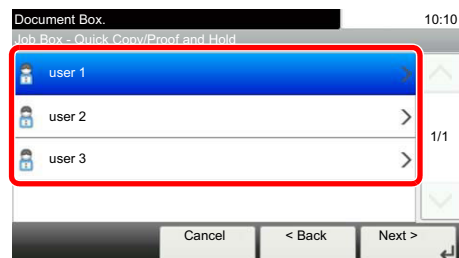

## 2 Delete the document.

- 1 Select the document to delete and press [  ].

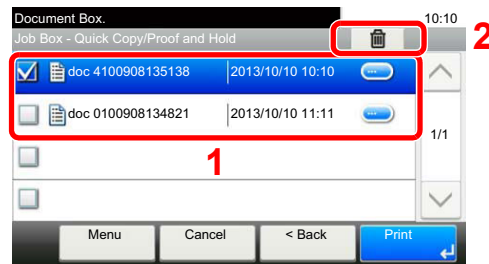

- 2 Press [Yes] in the confirmation screen.  
The document is deleted.

# 5 Operation on the Machine

This chapter explains the following topics:

Loading Originals .....	5-2
Placing Originals on the Platen .....	5-2
Loading Originals in the Document Processor .....	5-3
Favorites .....	5-5
Registering Favorite .....	5-6
Recalling Favorite .....	5-9
Editing and Deleting Favorite .....	5-10
Application .....	5-11
Installing Applications .....	5-11
Using Applications .....	5-12
Uninstalling Applications .....	5-13
Registering Shortcuts .....	5-14
Adding Shortcuts .....	5-14
Editing and Deleting Shortcuts .....	5-15
Copying .....	5-16
Basic Operation .....	5-16
Reserve Next .....	5-17
Canceling Jobs .....	5-18
Sending .....	5-19
Basic Operation .....	5-20
Specifying Destination .....	5-22
Checking and Editing Destinations .....	5-30
Confirmation Screen of Destinations .....	5-31
Recall .....	5-32
Send to Me (E-mail) .....	5-32
Sending to Different Types of Destinations (Multi Sending) .....	5-33
Canceling Sending Jobs .....	5-34
WSD Scan .....	5-35
Scanning using TWAIN .....	5-37
Scanning with FMU Connection .....	5-39
How to use the FAX Function .....	5-40
What is Document Box? .....	5-41
Basic Operation for Document Box .....	5-42
Using a Custom Box .....	5-43
Creating a New Custom Box .....	5-43
Editing and Deleting Custom Box .....	5-45
Storing Documents .....	5-46
Printing Documents .....	5-47
Editing Documents .....	5-48
Deleting Documents .....	5-49
Printing Documents Stored in Removable USB Memory .....	5-50
Saving Documents to USB Memory (Scan to USB) .....	5-52
Check the USB Memory Information .....	5-53
Removing USB Memory .....	5-54

# Loading Originals

## Placing Originals on the Platen

You may place books or magazines on the platen in addition to ordinary sheet originals.

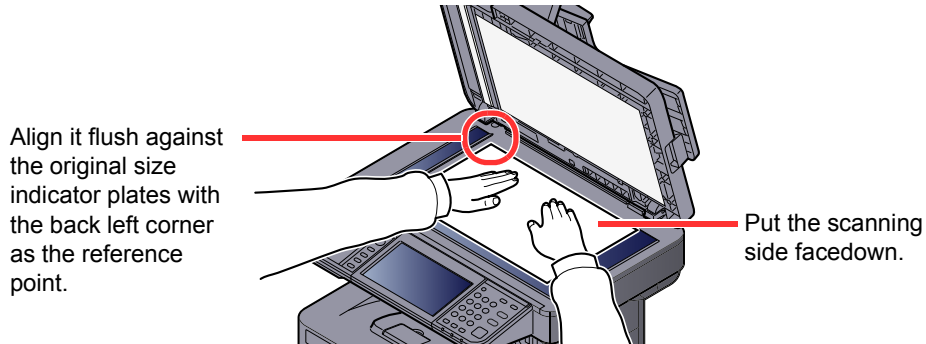

### NOTE

For details on Original Orientation, refer to [Original Orientation on page 6-10](#).

### When you place envelopes or cardstock on the platen

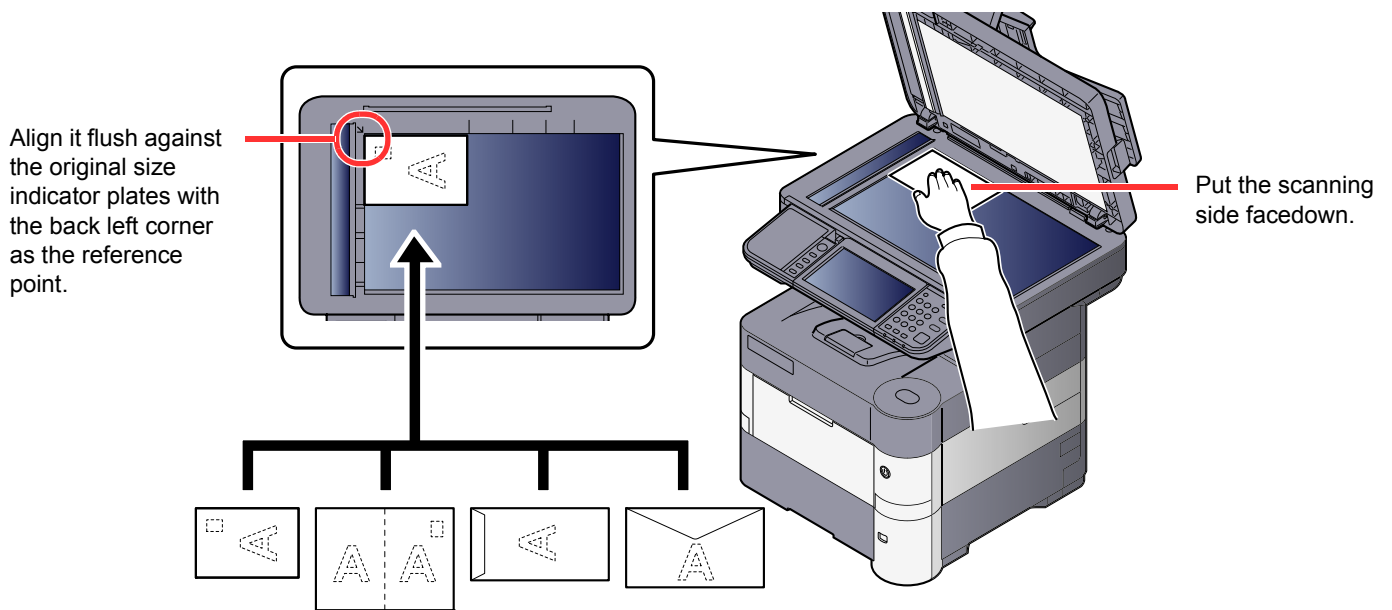

### NOTE

For the procedure for feeding envelopes or cardstock, refer to [When you load envelopes or cardstock in the multi purpose tray on page 3-20](#).

### CAUTION

Do not leave the document processor open as there is a danger of personal injury.

### IMPORTANT

- Do not push the document processor forcefully when you close it. Excessive pressure may crack the platen glass.
- When placing books or magazines on the machine, do so with the document processor in the open position.



## Loading Originals in the Document Processor

The document processor automatically scans each sheet of multiple originals. Both sides of two-sided originals are scanned.

### Originals Supported by the Document Processor

The document processor supports the following types of originals.

<b>Weight</b>	50 to 120 g/m <sup>2</sup> (duplex: 50 to 120 g/m <sup>2</sup> )
<b>Sizes</b>	Maximum A4-R (Legal) to Minimum A6-R (Statement-R)
<b>No. of sheets</b>	Plain paper (80 g/m <sup>2</sup> ), Colored paper, Recycled paper, High Quality: 75 sheets

### Originals Not Supported by the Document Processor

Do not use the document processor for the following types of originals. Otherwise, the originals may be jammed or the document processor may become dirty.

- Originals bound with clips or staples (Remove the clips or staples and straighten curls, wrinkles or creases before loading. Failure to do so may cause the originals to jam.)
- Originals with adhesive tape or glue
- Originals with cut-out sections
- Curled original
- Originals with folds (Straighten the folds before loading. Failure to do so may cause the originals to jam.)
- Carbon paper
- Crumpled paper

### How to Load Originals

#### ✔ IMPORTANT

- Before loading originals, be sure that there are no originals left on the original eject table. Originals left on the original eject table may cause the new originals to jam.
- Do not make an impact on the document processor top cover, such as aligning the originals on the top cover. It may cause an error in the document processor.

#### 1 Adjust the original width guides.

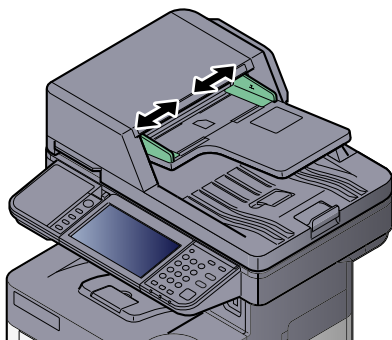

## 2 Place the originals.

- 1 Put the side to be scanned (or the first side of two-sided originals) face-up. Slide the leading edge into the document processor as far as it will go.

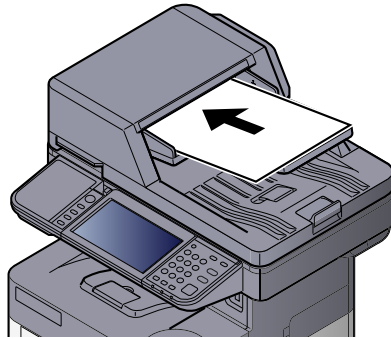

### NOTE

For details on Original Orientation, refer to [Original Orientation on page 6-10](#).

### IMPORTANT

- Confirm that the original width guides exactly fit the originals. If there is a gap, readjust the original width guides. The gap may cause the originals to jam.

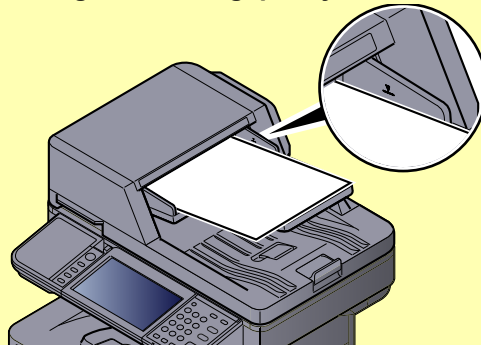

- Ensure that loaded originals do not exceed the level indicator. Exceeding the maximum level may cause the originals to jam.
- Originals with punched holes or perforated lines should be placed in such a way that the holes or perforations will be scanned last (not first).

- 2 Open the original stopper to fit the size of the original set.

A4, Letter, Legal

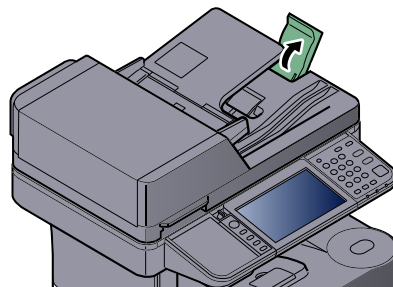

B5 or less

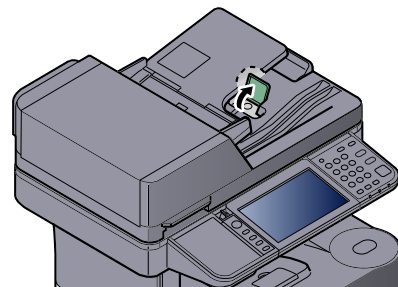

# Favorites

Frequently used functions can be registered as favorites so that they can be called up easily.

The following functions are pre-registered on this machine. You can delete these functions as well as register new functions.

Favorites Name	Description	Default Registration
<b>ID Card Copy</b>	Use this when you want to copy a driver's license or an insurance card. When you scan the front and back of the card, both sides will be combined and copied onto a single sheet.	<ul style="list-style-type: none"> <li>• Copying Functions</li> <li>• Program mode</li> <li>• Combine: [2 in 1]</li> <li>Continuous Scan: [On]</li> <li>Original Size: [A5-R]</li> <li>Paper Selection: Cassette 1</li> <li>Zoom: [Auto Zoom]</li> </ul>
<b>Paper Saving Copy</b>	Use this when you want to reduce paper use. Page combining and two-sided copying can be set by following the screen.	<ul style="list-style-type: none"> <li>• Copying Functions</li> <li>• Wizard mode</li> <li>• Combine: [2 in 1]</li> <li>2-sided/Original: [1-sided]</li> <li>Duplex: [1-sided&gt;&gt;2-sided]</li> <li>Paper Selection: Cassette 1</li> <li>Copies: 1</li> </ul>
<b>Scan to PC (Address Entry)</b>	Use this when you want to send the image to either a shared folder on a PC or an FTP server folder. The settings necessary for sending such as the destination and color selection can be set by following the screen.	<ul style="list-style-type: none"> <li>• Sending Functions</li> <li>• Wizard mode</li> <li>• Destination: New PC Folder</li> <li>Color Selection: [Full Color]</li> <li>File Name Entry: Default</li> <li>File Format: [PDF]</li> <li>Continuous Scan: [Off]</li> <li>Scan Resolution: [300×300 dpi]</li> </ul>
<b>Scan to PC (Address Book)</b>	Use this when you want to send the image to either a shared folder on a PC registered in the Address Book or to an FTP server folder. The settings necessary for sending such as the destination and color selection can be set by following the screen.	<ul style="list-style-type: none"> <li>• Sending Functions</li> <li>• Wizard mode</li> <li>• Destination: Address Book</li> <li>Color Selection: [Full Color]</li> <li>File Name Entry: Default</li> <li>File Format: [PDF]</li> <li>Continuous Scan: [Off]</li> <li>Scan Resolution: [300×300 dpi]</li> </ul>
<b>Scan to E-mail (Address Entry)</b>	Use this when you want to send the image to an E-mail address. The settings necessary for sending such as the destination and color selection can be set by following the screen.	<ul style="list-style-type: none"> <li>• Sending Functions</li> <li>• Wizard mode</li> <li>• Destination: New E-mail Address</li> <li>Color Selection: [Full Color]</li> <li>File Name Entry: Default</li> <li>File Format: [PDF]</li> <li>Continuous Scan: [Off]</li> <li>Scan Resolution: [300×300 dpi]</li> <li>E-mail subject: Default</li> <li>E-mail body: Default</li> </ul>

Favorites Name	Description	Default Registration
<b>Scan to E-mail (Address Book)</b>	Use this when you want to send the image to an E-mail address registered in the Address Book. The settings necessary for sending such as the destination and color selection can be set by following the screen.	<ul style="list-style-type: none"> <li>• Sending Functions</li> <li>• Wizard mode</li> <li>• Destination: Address Book</li> <li>Color Selection: [Full Color]</li> <li>File Name Entry: Default</li> <li>File Format: [PDF]</li> <li>Continuous Scan: [Off]</li> <li>Scan Resolution: [300×300 dpi]</li> <li>E-mail subject: Default</li> <li>E-mail body: Default</li> </ul>

 **NOTE**

Up to 20 settings can be registered as favorites.

## Registering Favorite

When registering a favorite, you can choose from two methods for calling it up:

- Wizard mode: Registered settings are called up in order and configured as you check or change each one.
- Program mode: Settings are called up immediately when you press the key to which they are registered.

Sending is explained as an example below.

### Wizard Mode

#### 1 Display the screen.

Press [Favorites] on the Home screen.



#### 2 Register the favorite.

- 1 Press [Menu] and then [Add].
- 2 Select the job type.
- 3 Press [Wizard].
- 4 Select the recall function then press [Next].

#### Destination Recall Method

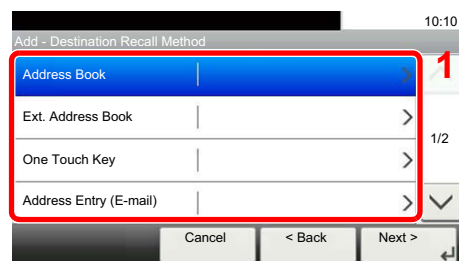

#### Functions

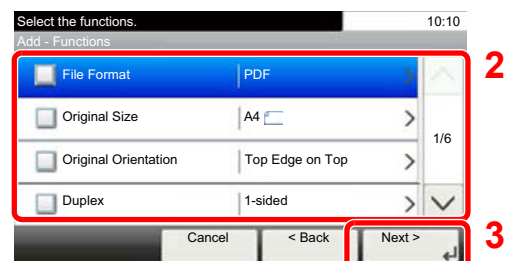

Checked items will be shown as part of the wizard.

 **NOTE**

When the job type is “Copy”, the Destination Recall Method screen will not be displayed.

- 5 Enter the new favorite name and press [Next].

 [Character Entry Method \(page 11-12\)](#)

- 6 Check the settings and change or add information as needed.

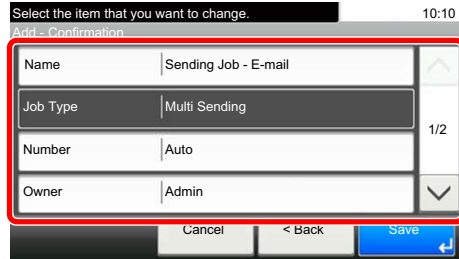

Item	Description
<b>Name</b>	Enter the name displayed on the favorite screen (up to 32 characters).
<b>Job Type</b>	The type of the selected job is displayed.
<b>Number<sup>*1</sup></b>	Enter the favorite number. If you enter 00, the smallest number available will be automatically assigned.
<b>Owner<sup>*2</sup></b>	Displays the owner of the favorite.
<b>Permission<sup>*2</sup></b>	Configures permission settings for favorites to determine how they are shared with other users.
<b>Destination<sup>*3</sup></b>	Selects the Destination Recall Method.
<b>Functions</b>	Selects the functions to be displayed in the wizard.
<b>Function Type</b>	Selects the method for recalling favorites.

\*1 If user login administration is enabled, you can only change the settings by logging in with administrator privileges.

\*2 Displayed when user login administration is enabled.

\*3 Displayed when the job type is [Send] or [FAX].

- 7 Press [Save].

The favorite is registered.

- 8 “Do you want to add a new function to the home screen?” screen appears. To display a registered favorite on the Home screen, press [Yes] and specify the position in which you want to display the icon of registered favorite.

- 9 Press [Save].

## Program Mode

### 1 Display the screen.

- 1 Press [Send] on the Home screen.



- 2 Set the send function and press [Favorites].

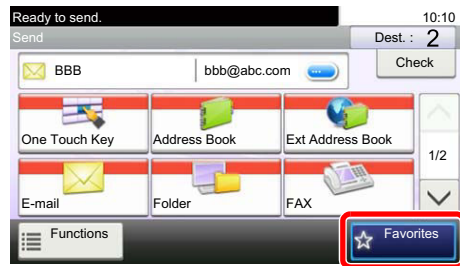

### 2 Register the favorite.

- 1 Press [Menu] and then [Add].
- 2 Select the job type.
- 3 Press [Program].
- 4 Enter the new favorite name and press [Next].



[Character Entry Method \(page 11-12\)](#)

- 5 Check the settings and change or add information as needed.

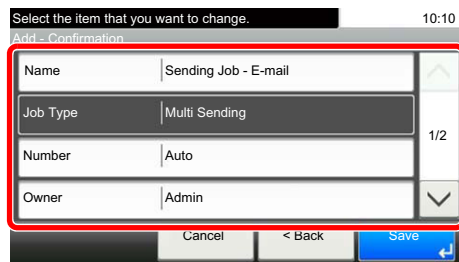

Item	Description
<b>Name</b>	Enter the name displayed on the favorite screen (up to 32 characters).
<b>Job Type</b>	The type of the selected job is displayed.
<b>Number<sup>*1</sup></b>	Enter the favorite number. If you enter 00, the smallest number available will be automatically assigned.
<b>Owner<sup>*2</sup></b>	Displays the owner of the favorite.
<b>Permission<sup>*2</sup></b>	Configures permission settings for favorites to determine how they are shared with other users.
<b>Function Type</b>	Selects the method for recalling favorites.

\*1 If user login administration is enabled, you can only change the settings by logging in with administrator privileges.

\*2 Displayed when user login administration is enabled.

**6** Press [Save].

The favorite is registered.

**7** “Do you want to add a new function to the home screen?” screen appears. To display a registered favorite on the Home screen, press [Yes] and specify the position in which you want to display the icon of registered favorite.

**8** Press [Save].

## Recalling Favorite

Use the procedure below to recall a registered favorite.

### 1 Display the screen.

**1** Press [Favorites] on the Home screen, or the key of the registered favorite.



Pressing the key of the registered favorite will recall the favorite. If you pressed [Favorites], proceed to step 1-2.

**2** Press the key for the favorite you want to recall.

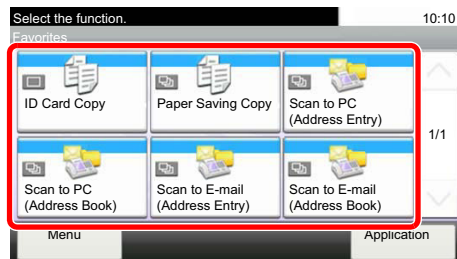

## 2 Execute the favorite.

### When using the wizard mode

- 1 The registered screens are displayed in order. Make the desired settings and press [Next].  
When all the settings are complete, the confirmation screen is displayed.

#### NOTE

To edit the settings, press [<Back] and make changes as desired.

- 2 Place the originals and press [Start].

### When using the program mode

Place the originals and press the [Start] key.

## Editing and Deleting Favorite

You can change favorite number and favorite name, or delete favorite.

Use the procedure below to edit or delete a favorite.

### 1 Display the screen.

Press [Favorites] on the Home screen.



### 2 Edit the favorite.

#### To edit a favorite

- 1 Press [Menu] and then [Edit].
- 2 Select the favorite you wish to edit.
- 3 Refer to [Registering Favorite on page 5-6](#) to change the favorite number, favorite name, permission.
- 4 Press [Save].
- 5 Press [Yes] in the confirmation screen.

#### To delete

- 1 Press [Menu] and then [Delete].
- 2 Select the favorite you wish to delete.
- 3 Press [Yes] in the confirmation screen.



# Application

The functionality of the machine can be expanded by installing applications.

Applications that help you perform your daily more efficiently such as a scan feature and an authentication feature are available.

For details, consult your sales representative or dealer.

## Installing Applications

To use applications, first install the application in the machine and then activate the application.

The procedure is as follows.

### 1 Display the screen.

- 1 Press the [System Menu/Counter] key.

System Menu /  
Counter



- 2 Press [∨], [Application] and then [Application].



#### NOTE

If the user authentication screen appears, enter your login user name and login password and press [Login]. For this, you need to login with administrator privileges. The factory default login user name and login password are set as shown below.

Model Name	Login User Name	Login Password
ECOSYS M3040idn/ ECOSYS M3540idn	4000	4000
ECOSYS M3550idn	5000	5000
ECOSYS M3560idn	6000	6000

### 2 Install the application.

- 1 Press [+].
- 2 Insert the removable memory containing the application to be installed into the USB Port.



#### NOTE

When the message "Removable Memory was recognized. Displaying files. Are you sure?" is displayed, press [No].

- 3 Select the application to be installed and press [Install].

You can view detailed information on the selected application by pressing [ ].

**4** Press [Yes] in the confirmation screen.

Installation of the application begins. Depending on the application being installed, the installation may take some time.

Once the installation ends, the original screen reappears.



**NOTE**

- To install another application, repeat steps 2-3 and 2-4.
- To remove the removable memory, press [Remove Memory] and wait until the message "Removable Memory can be safely removed." appears. Then remove the removable memory.

### **3 Activate the application.**

**1** Select the desired application and press [Menu] and then [Activate].

You can view detailed information on the selected application by pressing [].

**2** Enter the license key and press [Official].

Some applications do not require you to enter a license key. If the license key entry screen does not appear, go to step 3-3. To use the application as a trial, press [Trial] without entering the license key.

**3** Press [Yes] in the confirmation screen.



**IMPORTANT**

**If you change the date/time while using the trial version of an application, you will no longer be able to use the application.**

## **Using Applications**

Icons of activated application are displayed in the Home screen. Press the application icon in the Home screen.

The application will start up.

# Uninstalling Applications

A maximum of 5 applications can be installed on the machine. To add different applications, uninstall an application that has been installed. Deactivate an application before uninstalling it.

The procedure is as follows.

## 1 Display the screen.

- 1 Press the [System Menu/Counter] key.

System Menu /  
Counter



- 2 Press [∨], [Application] and then [Application].

### NOTE



If the user authentication screen appears, enter your login user name and login password and press [Login]. For this, you need to login with administrator privileges. The factory default login user name and login password are set as shown below.

Model Name	Login User Name	Login Password
ECOSYS M3040idn/ ECOSYS M3540idn	4000	4000
ECOSYS M3550idn	5000	5000
ECOSYS M3560idn	6000	6000

## 2 Deactivate the application.

- 1 Select the application you want to deactivate and press [Menu] and then [Deactivate].  
You can view detailed information on the selected application by pressing [].
- 2 Press [Yes] in the confirmation screen.

## 3 Uninstall the application.

- 1 Select the application you want to uninstall, and press [].  
You can view detailed information on the selected application by pressing [].
- 2 When the deletion confirmation screen appears, press [Yes].

# Registering Shortcuts

You can register shortcuts for easy access to the frequently used functions. The settings for the selected function can also be registered. A function name linked to a registered shortcut can be changed as necessary. You can register up to 2 shortcuts for copying functions, sending functions, fax functions, and functions set for document box.

## Adding Shortcuts

Shortcut registration is performed in the “Functions” screen of each function. Use the procedure below to register a shortcut.

### 1 Display the screen.

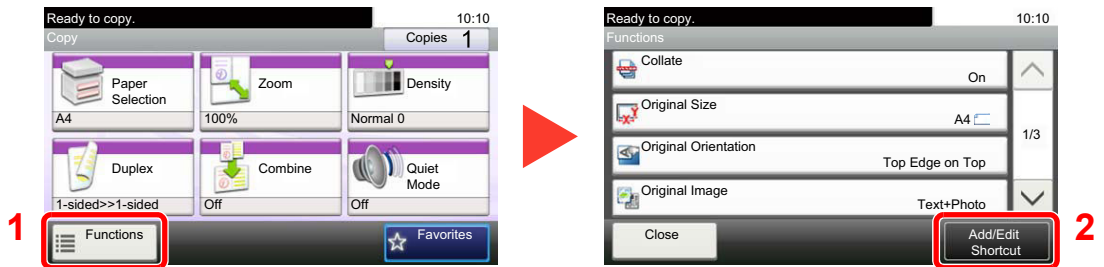

Press [Functions] on the Copy, Send, or Document Box screen and then [Add/Edit Shortcut].

### 2 Register the shortcuts.

- 1 Press [Add].
- 2 Select the key to which you wish to register the shortcut.

The following types of shortcuts are available:

<b>Private Shortcut</b>	Private shortcuts are only available for use by the logged in user. They can only be set while using user login administration.
<b>Shared Shortcut</b>	Shared shortcuts can be used by all machine users. When using user login administration, shared shortcuts can only be set by users who have logged in as administrators.

#### NOTE

If you select a shortcut number already registered, the currently registered shortcut can be replaced with a new one.

- 3 Select the function screen to display with the shortcut.
- 4 Enter the shortcut name.

Up to 24 characters can be entered.

 [Character Entry Method \(page 11-12\)](#)

- 5 Press [Save].

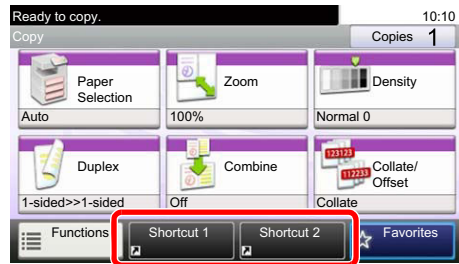

The shortcut is registered.

## Editing and Deleting Shortcuts

Follow the steps shown below to change a shortcut number/name or delete a shortcut.

- 1 **In the "Functions" screen of each function, press [Add/Edit Shortcut] in the bottom of the screen.**

- 2 **Edit the shortcut.**

### To edit a shortcut

- 1 Press [Edit].
- 2 Select the shortcut type and number you wish to edit.
- 3 Press [Number] or [Name].
- 4 Change the settings, and press [OK].
- 5 Press [Save].
- 6 Press [Yes] in the confirmation screen.

### To delete

- 1 Press [Delete].
- 2 Select the shortcut you wish to delete.
- 3 Press [Yes] in the confirmation screen.

# Copying

## Basic Operation

Follow the steps as below for basic copying.

### 1 Press [Copy] on the Home screen.



### 2 Place the originals.

Place the originals.

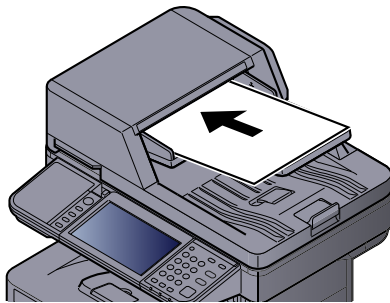

 [Loading Originals \(page 5-2\)](#)

### 3 Select the functions.

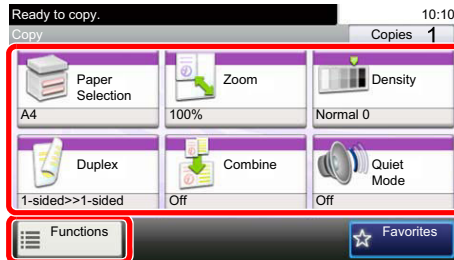

Select the copier functions to use.

Press tabs to display other functions.

 [Copy \(page 6-2\)](#)

### 4 Use the numeric keys to enter the copy quantity.

Specify the desired number up to 999.

### 5 Press the [Start] key.

Copying begins.

## Reserve Next

This function allows you to reserve the next job during printing. Using this function, the original will be scanned while the machine is printing. When the current print job ends, the reserved copy job is printed.

The procedure differs depending on the Reserve Next Priority (refer to [Reserve Next Priority on page 8-20](#)).

### If "Reserve Next Priority" is set to [On]

The Copy function default screen appears on the touch panel during printing.

- 1 Place the originals onto the machine for reserving copy, and configure the copy settings.**

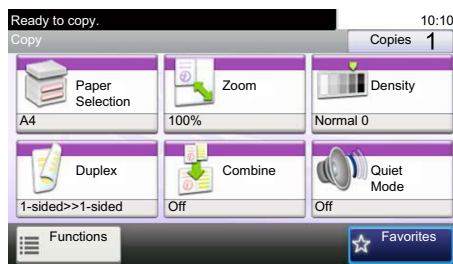

- 2 Press the [Start] key.**

The machine starts scanning the originals.

When the current print job ends, the reserved copy job is printed.

### If "Reserve Next Priority" is set to [Off]

The Copying screen appears on the touch panel during printing.

- 1 Press [Reserve Next].**

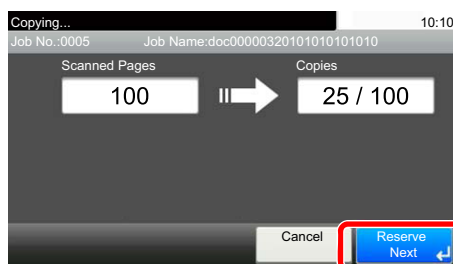

The default screen for copying appears.

- 2 Place the originals onto the machine for reserving copy, and configure the copy settings.**

- 3 Press the [Start] key.**

The machine starts scanning the originals.

When the current print job ends, the reserved copy job is printed.

## Canceling Jobs

You can also cancel jobs by pressing the [Stop] key.

- 1 Press the [Stop] key with the copy screen displayed.
- 2 Cancel a job.

When there is a job is being scanned

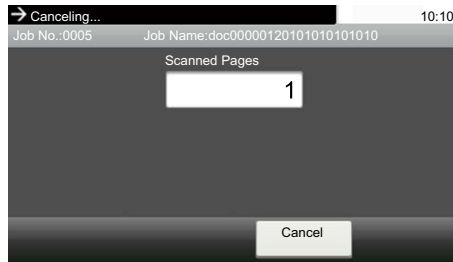

The copy job is canceled.

When there is a job printing or on standby

Canceling job screen appears. The current print job is temporarily interrupted.

Select the job you wish to cancel and press [Delete]. Press [Yes] in the confirmation screen.

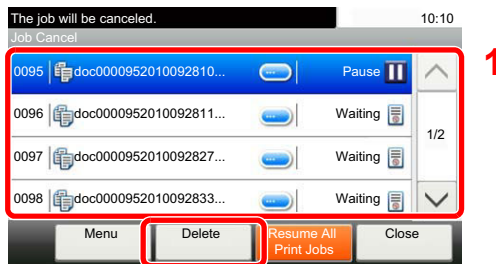

### NOTE

If [Reserve Next Priority on page 8-20](#) is set to [Off], the Copying screen appears in the touch panel. In such case, pressing the [Stop] key or [Cancel] will cancel the printing job in progress.

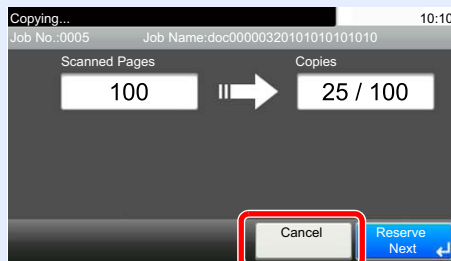



## Sending

This machine can send a scanned image as an attachment of an E-mail message or to a PC linked to the network. In order to do this, it is necessary to register the sender and destination (recipient) address on the network.

A network environment which enables the machine to connect to a mail server is required in order to send E-mail. It is recommended that a Local Area Network (LAN) be used to assist with transmission speed and security issues.

Follow the steps below for basic sending. The following four options are available.

- Send as E-mail (E-mail Addr Entry): Sends a scanned original image as an E-mail attachment.

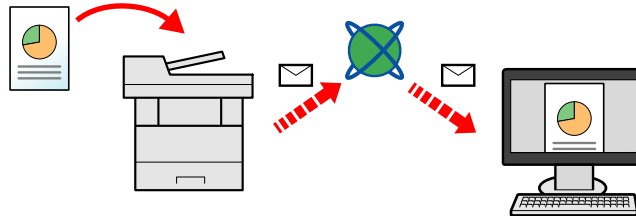

- Send to Folder (SMB): Stores a scanned original image in a shared folder of any PC. (Refer to [page 5-20.](#))
- Send to Folder (FTP): Stores a scanned original image in a folder of an FTP server. (Refer to [page 5-20.](#))

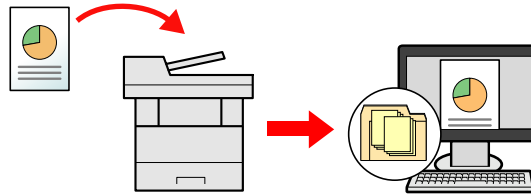

- Image Data Scanning with TWAIN / WIA: Scan the document using a TWAIN or WIA compatible application program. (Refer to [page 5-37.](#))



### NOTE

- Different sending options can be specified in combination. Refer to [Sending to Different Types of Destinations \(Multi Sending\) on page 5-33.](#)
- The fax function can be used on products equipped with fax capability. For details about this function, refer to the **FAX Operation Guide.**

## Basic Operation

### 1 Press [Send] on the Home screen.



### 2 Place the originals.

Place the originals.

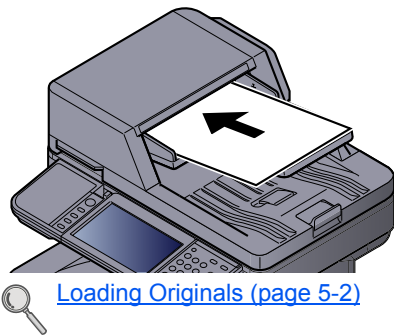

[Loading Originals \(page 5-2\)](#)

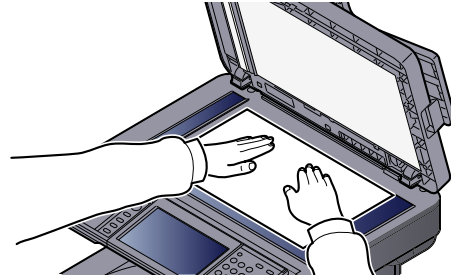

### 3 Specify the destination.

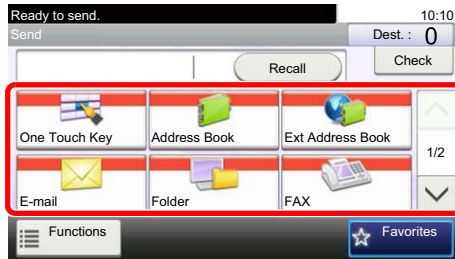

Select the destination to which to send an image.

[Specifying Destination \(page 5-22\)](#)

#### Choosing a Destination from the External Address Book

For details on the External Address Book, refer to **Command Center RX User Guide**.

#### Choosing a Destination from the FAX

For more information on using the FAX, refer to the **FAX Operation Guide**.

## 4 Select the functions.

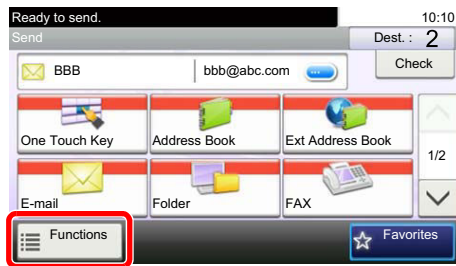

Press tabs to display other functions.

 [Send \(page 6-3\)](#)

## 5 Press the **[Start]** key.

Sending starts.

## Specifying Destination

Select the destination using either of the following methods:



[Choosing from the Address Book \(page 5-22\)](#)



Choosing from the External Address Book

For details on the External Address Book, refer to **Command Center RX User Guide**.

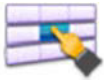

[Choosing from the One Touch Key \(page 5-24\)](#)



[Entering an E-mail Address \(page 5-25\)](#)



[Specifying a New PC Folder \(page 5-26\)](#)



Choosing from the FAX

For more information on using the FAX, refer to the **FAX Operation Guide**.

### NOTE

- You can set the machine up so that the address book screen appears when you press the [**Send**] key. For details, refer to [Default Screen on page 8-21](#).
- If you are using the products equipped with the fax function, you can specify the fax destination. Enter the other party number using the numeric keypad.

## Choosing from the Address Book

Select a destination registered in the Address Book.

For more information about how to register destinations in the Address Book, refer to [Registering Destinations in the Address Book on page 3-35](#).

### 1 In the basic screen for sending, press [**Address Book**].

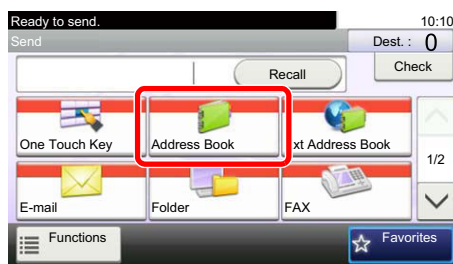

### NOTE

For details on the External Address Book, refer to **Command Center RX User Guide**.

## 2 Select the destinations.

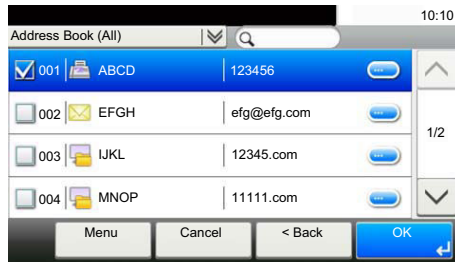

Press the checkbox to select the desired destination from the list. The selected destinations are indicated by a checkmark in the check box.

You can also press [Menu] to perform a more detailed search.



### NOTE

To deselect, press the checkbox again and remove the checkmark.

## Destination Search

Destinations registered in the Address Book can be searched.



Keys used		Search type	Subjects searched
1		Advanced search by destination	Advanced search by type of registered destination (Email, Folder (SMB/FTP), FAX or Group).
2		Search by name	Search by registered name.
3	<b>Narrow Down</b>	Advanced search by destination	Advanced search by type of registered destination (Email, Folder (SMB/FTP), FAX or Group).
	<b>Search (Name)</b>	Search by name	Search by registered name.
	<b>Search (No.)</b>	Search by number	Search by registered address number.
	<b>Sort (Name)</b>	Change of display order	Sorts the list by destination name.
	<b>Sort (No.)</b>		Sorts the list by destination address number.



### NOTE

You can specify a destination by address number by pressing the **[Quick No. Search]** key.

### 3 Accept the destination, and press [OK].

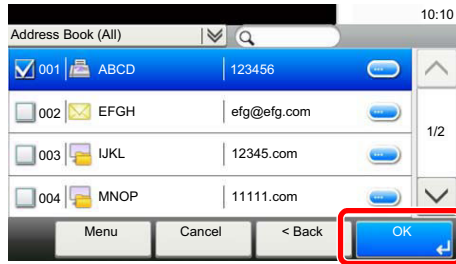

Destinations can be changed later. Refer to [Checking and Editing Destinations on page 5-30](#).



#### NOTE

You can set the default "Sort" settings. For details, refer to [Sort on page 8-24](#).

## Choosing from the One Touch Key

Select the destination using the One Touch Keys.



#### NOTE

This procedure assumes that One Touch Keys have already been registered.

Refer to [Adding a Destination on One Touch Key \(One Touch Key\) on page 3-41](#) for more information on adding One Touch keys.

### 1 In the basic screen for sending, press [One Touch Key].

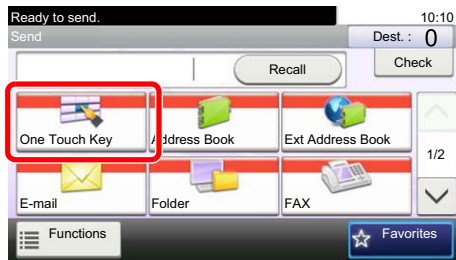

### 2 Press the One Touch Keys where the destination is registered.

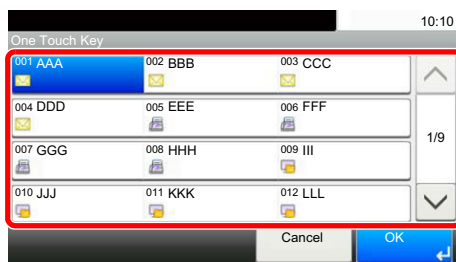

If the One Touch Keys for the desired destination is hidden on the touch panel, press [∨] or [∧] to scroll and view next or previous One Touch Keys.



#### NOTE

You can specify a One Touch Key by one touch number by pressing the [Quick No. Search] key.

### 3 Accept the destination, and press [OK].

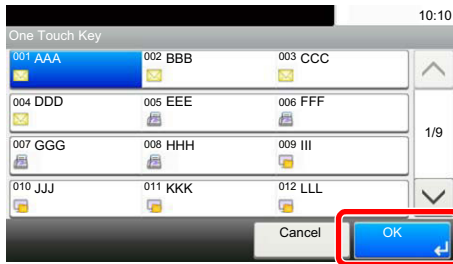

Destinations can be changed later. Refer to [Checking and Editing Destinations on page 5-30](#).

## Entering an E-mail Address

Enter the desired E-mail address.

### NOTE

To send an E-mail, configure the environment settings necessary. For details, refer to [E-mail Settings on page 2-41](#).

### 1 In the basic screen for sending, press [E-mail].

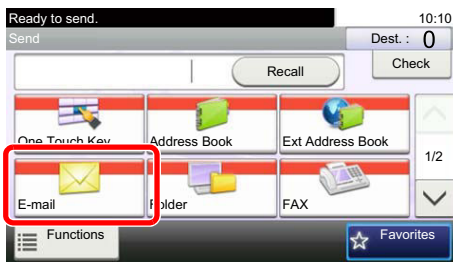

### 2 Enter destination E-mail address.



Up to 128 characters can be entered.

[Character Entry Method \(page 11-12\)](#)

To enter multiple destinations, press [Next Destination] and enter the next destination. Up to 100 E-mail addresses can be specified.

You can register the entered email address in the Address Book by pressing [Menu] and then [Add to Address Book]. You can also replace the information for a previously registered destination.

### 3 Press [OK].

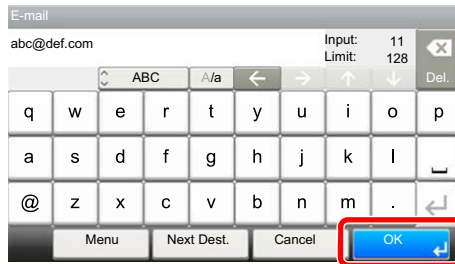

Destinations can be changed later. Refer to [Checking and Editing Destinations on page 5-30](#).

## Specifying a New PC Folder

Specify either the desired shared folder on a computer or an FTP server as the destination.

### NOTE

- Refer to [Preparation for Sending a Document to a Shared Folder in a PC on page 3-25](#) for the method for setting a shared folder destination on a PC.
- Refer to [Creating a Shared Folder, Making a Note of a Shared Folder on page 3-27](#) for details on how to share a folder.
- Be sure that SMB Protocol or FTP is On. For details, refer to [Protocol Detail on page 8-29](#).

### 1 In the basic screen for sending, press [Folder].

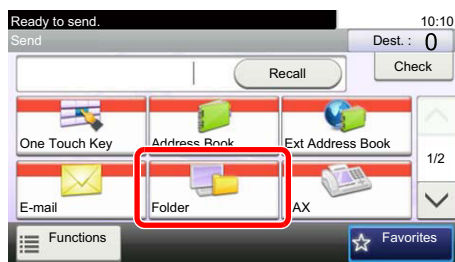

### 2 Select the folder type.

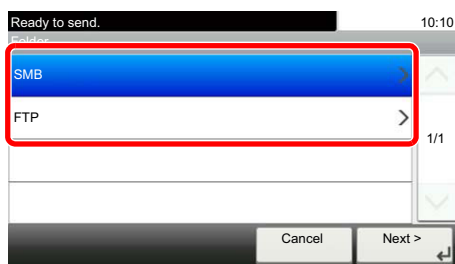

If you selected [FTP], go to step 4.



### 3 Select the folder specification method.

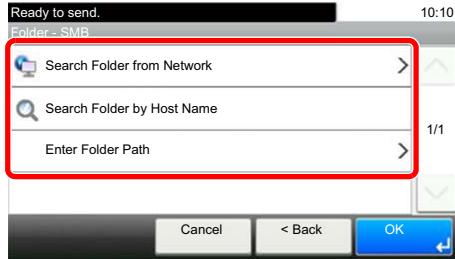

To search for a folder on a PC on the network, press [Search Folder from Network] or [Search Folder by Host Name].

If you pressed [Search Folder from Network], you can enter the "Domain/Workgroup", and "Host Name" to search PCs on the network for the destination.

If you pressed [Search Folder by Host Name], you can search all PCs on the network for a destination.

A maximum of 500 addresses can be displayed. Select the host name (PC name) that you want to specify in the screen that appears, and press [Next]. The login user name and login password entry screen appears.

After you enter the login user name and login password name of the destination PC, the shared folders appear. Select the folder that you want to specify and press [Next]. The address of the selected shared folder is set.

Select the folder from the Search Results list, and go to step 6.

If you selected [Enter Folder Path], go to step 4.

### 4 Enter the destination information.



Enter the next information. Once you have entered one item, press [Next] to advance to the next item.

 [Character Entry Method \(page 11-12\)](#)

The table below lists the items to be set.

#### For send to folder (SMB)

Item	Detail	Max. characters
Host Name	Computer name	Up to 64 characters
Path	Share name For example: scannerdata If saving in a folder in the shared folder: share name\folder name in shared folder	Up to 128 characters

Item	Detail	Max. characters
<b>Login User Name</b>	If the computer name and domain name are the same: User Name For example: james.smith If the computer name and domain name are different: Domain name\User name For example: abcdnet\james.smith	Up to 64 characters
<b>Login Password</b>	Windows logon password <b>(Case sensitive.)</b>	Up to 64 characters

**For send to folder (FTP)**

Item	Data to be entered	Max. characters
<b>Host Name</b>	Host name or IP address of FTP server	Up to 64 characters
<b>Path</b> <sup>*1</sup>	Path to the receiving folder For example: User\ScanData Otherwise the data will be saved in the home directory.	Up to 128 characters
<b>Login User Name</b>	FTP server login user name	Up to 64 characters
<b>Login Password</b>	FTP server login password <b>(Case sensitive.)</b>	Up to 64 characters

\*1 When the FTP server is based on Linux/UNIX, the path including the sub-folder is combined by the slash "/" not using the back-slash.

## 5 Check the status.

### 1 Check the information.

Change the delay as required.

**2** Press [Menu] and then [Connection Test] to check the connection.



"Connected." appears when connection to the destination is correctly established. If "Cannot connect." appears, review the entry.

To enter multiple destinations, press [Next Destination] and enter the next destination.

You can register the entered information in the Address Book by pressing [Add to Address Book].

**6** Press [OK].

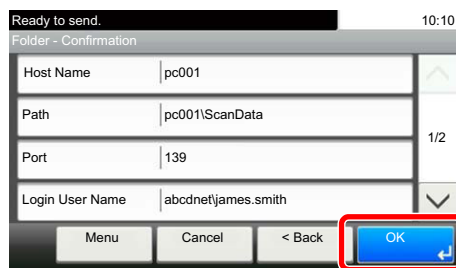

Destinations can be changed later. Refer to [Checking and Editing Destinations on page 5-30](#).

## Checking and Editing Destinations

Check and edit a selected destination.

### 1 Display the screen.

- 1 Referring to [Specifying Destination on page 5-22](#), specify the destination.
- 2 Press [Check].

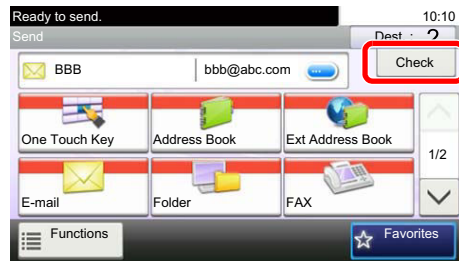

### 2 Check and edit the destination.

To add a new destination, press [+].

To display details for the destinations, press [OK]. New E-mail addresses and PC folders can be edited if they have been specified.

To delete the selected destination, press [Delete].



#### NOTE

- When selecting [On] for Entry Check for New Destination ([Entry Check for New Dest. on page 8-21](#)), the confirmation screen appears. Enter the same host name and path again, and press [OK].
- When selecting [On] for Destination Check before Send ([Dest. Check before Send on page 8-21](#)), the confirmation screen appears after pressing the [Start] key. For details, refer to [Confirmation Screen of Destinations on page 5-31](#).

## Confirmation Screen of Destinations

When selecting [On] for Destination Check before Send ([Dest. Check before Send on page 8-21](#)), the confirmation screen of destinations appears after pressing the [Start] key.

Follow the steps below to confirm the destinations.

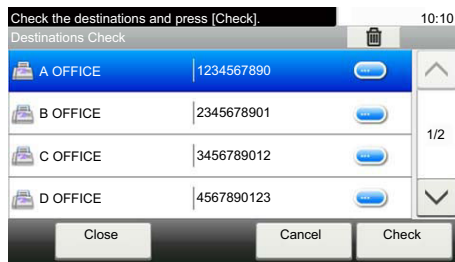

- 1 Press [∨] or [∧] to confirm all destination.

Pressing [☑] shows the detailed information of the selected destination.

To delete the destination, select the destination you want to delete and press [🗑]. Press [Yes] in the confirmation screen. The destination is deleted.

To add the destination, press [Cancel] and then return to the destination screen.

- 2 Press [Check].



### NOTE

Be sure to confirm all destination by displaying them on the touch panel. You cannot press [Check] unless you have confirmed all destination.

## Recall

Recall is a function allowing you to send the last entered destination once again. When you want to send the image to the same destination, press [Recall], and you can call the destination you sent on the destination list.

**1** Press [Recall].

The destination you sent is displayed on the destination list.

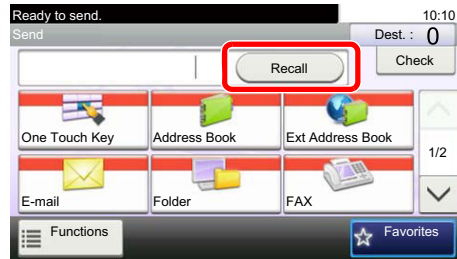

**NOTE**

When the last sending included FAX, computers and e-mail destinations, they are also displayed. If necessary, add or delete the destination.

**2** Press the [Start] key.

Sending starts.

**NOTE**

- When [On] is selected in "Dest. Check before Send", a destination confirmation screen is displayed when you press the [Start] key. For details, refer to [Confirmation Screen of Destinations on page 5-31](#).
- Recall information is canceled in the following conditions.
  - When you turn the power off
  - When you send a next image (new recall information is registered)
  - When you log out

## Send to Me (E-mail)

When user login is enabled, the document is sent to the E-mail address of the logged in user.



**NOTE**

- To use this function, the function icon must be displayed in the home screen.

 [Editing the Home Screen \(page 3-5\)](#)

- An E-mail address must be set in user login for the user who logs in.

 [Adding a User \(Local User List\) \(page 9-5\)](#)

## Sending to Different Types of Destinations (Multi Sending)

You can specify destinations that combine E-mail addresses, folders (SMB or FTP) and fax numbers<sup>\*1</sup>. This is referred to as Multi Sending. This is useful for sending to different types of destination (E-mail addresses, folders, etc.) in a single operation.

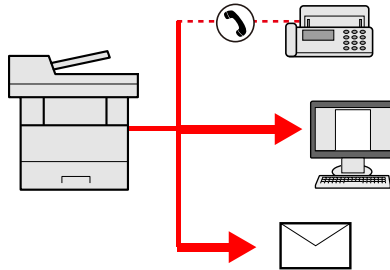

\*1 Fax functionality can only be used on products equipped with fax capability.

No. of broadcast items

E-mail: Up to 100

Folders (SMB, FTP): Total of 5 SMB and FTP

FAX: Up to 100

Procedures are the same as used in specifying the destinations of respective types. Continue to enter E-mail address or folder path so that they appear in the destination list. Press the **[Start]** key to start transmission to all destinations at one time.



### NOTE

If the destinations include a fax, the images sent to all destinations will be black and white.

## Canceling Sending Jobs

You can also cancel jobs by pressing the [Stop] key.

- 1 Press the [Stop] key with the send screen displayed.**
- 2 Cancel a job.**

When there is a job is being scanned

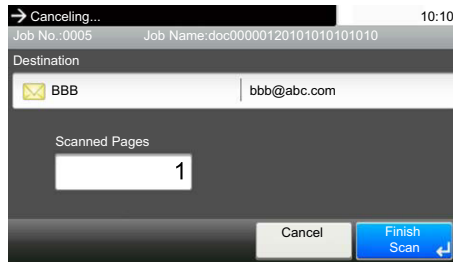

Job Cancel appears.

When there is a job sending or on standby

Canceling job screen appears.

Select the job you wish to cancel and press [Delete]. Press [Yes] in the confirmation screen.

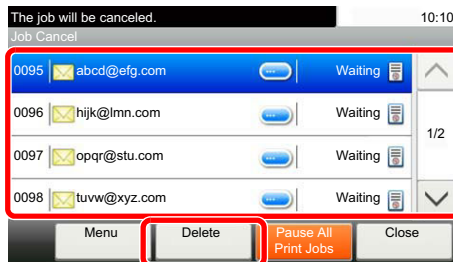

### NOTE

Pressing the [Stop] key will not temporarily stop a job that you have already started sending.



## WSD Scan

WSD Scan saves images of originals scanned on this machine as files on a WSD-compatible computer.

### NOTE

- To use WSD Scan, confirm that the computer used for WSD scanning and the machine is network-connected, and [WSD Scan on page 8-30](#) is set to [On] in the network settings.
- For information on operating the computer, refer to the computer's help or the operation guide of your software.

## Installing Driver Software (for Windows 7)

### 1 Display **[Network]** in the Start menu.

Click **[Start]** button on the Windows and then select **[Network]**.

### NOTE

When **[Network]** does not appear in the Start menu, perform the following procedure.

- 1 Right-click **[Start]** and click **[Property]** in the menu that appears.
- 2 Select the **[[Start] menu]** tab in the "**Task bar and [Start] menu properties**" screen, and click **[Customize]**.
- 3 When the "**Customize [Start] menu**" screen appears, select the "**Network**" check box and click **[OK]**.

### 2 Install the driver.

Right-click the machine's icon (Kyocera:ECOSYSXXX:XXX) and then click **[Install]**.

### NOTE

If the "**User Account Control**" window appears, click **[Continue]**.  
If the "**Found New Hardware**" window appears, click **[Cancel]**.

During the installation, double-click the icon shown on the task bar to display the "**Driver Software Installation**" screen. When "**Your devices are ready to use**" is displayed on the **[Driver Software Installation]** screen, the installation is completed.

## Installing Driver Software (for Windows 8 and Microsoft Windows Server 2012)

### 1 Click **[Search]** in charms, **[Control Panel]**, and then **[View devices and printers]**.

### 2 Install the driver.

Click **[Add a device]**. Select the machine's icon (Kyocera:ECOSYSXXX:XXX) and then click **[Next]**.

When the machine's icon (Kyocera:ECOSYSXXX:XXX) is displayed in "**Printers**" on the **[Devices and Printers]** screen, the installation is completed.

## WSD scan

### 1 Press [Send] on the Home screen.



### 2 Place the originals.

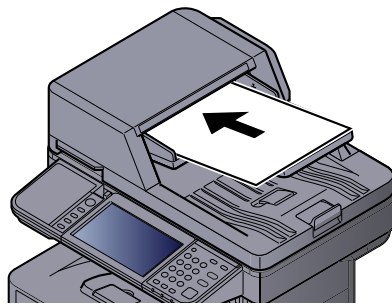

 [Loading Originals \(page 5-2\)](#)



### 3 Display the screen.

Press [WSD Scan].

### 4 Scan the originals.

#### Procedure using this machine

- 1 Select [From Operation Panel] and press [Next].
- 2 Select the destination computer and press [OK].  
Press [Reload] to reload the computer list.

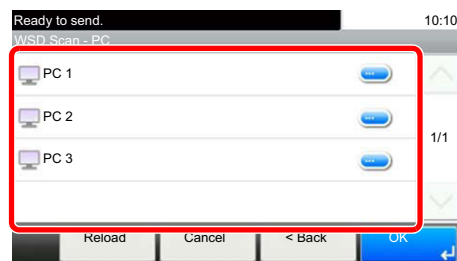

You can view information on the selected computer by pressing [].

### 3 Press the [Start] key.

Sending begins and the software installed on the computer is activated.

#### Procedure from Your Computer

- 1 Press [From Computer] and press [Next].
- 2 Use the software installed on the computer to send the images.

# Scanning using TWAIN

This section explains how to scan an original using TWAIN.

The procedure for scanning using the TWAIN driver is explained as an example. The WIA driver is used in the same way.

## 1 Display the screen.

- 1 Activate the TWAIN compatible application software.
- 2 Select the machine using the application and display the TWAIN dialog box.



### NOTE

For selecting the machine, see the Operation Guide or Help for each application software.

## 2 Configure the scan settings.

Select scanning settings in the TWAIN dialog box that opens.

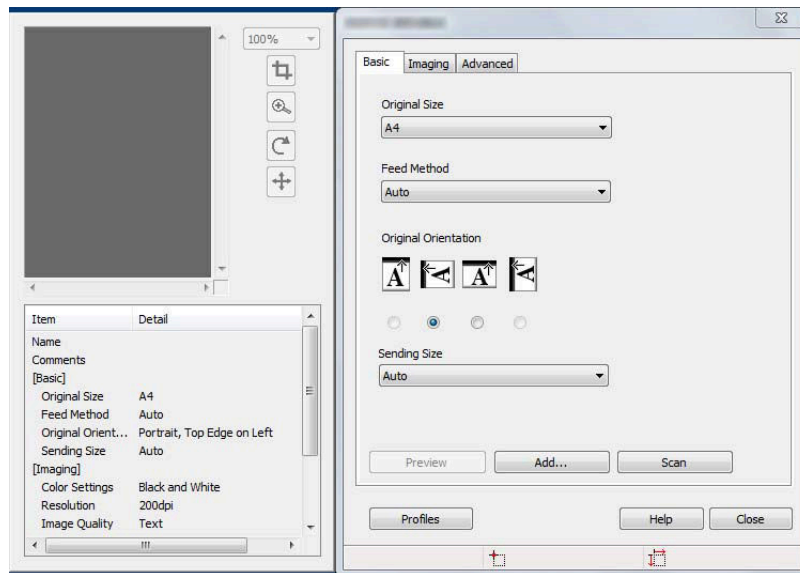

The settings that appear in the TWAIN dialog box are as follows.

Item		Detail
Basic	Original Size	This setting sets the size of the scan area. The available sizes vary based on the scanner model and the size of the original.
	Feed Method	This setting specifies the feed method of the original. Select the feed method from the list.
	Original Orientation	This setting specifies the orientation of the original.
	Sending Size	This setting specifies the image size. The available sizes vary based on the scanner model and the scan area selected in the preview panel.

Item		Detail
Imaging	Color Settings	This setting specifies the type of color for the image.
	Resolution	This setting specifies the dpi (dots per inch), or sharpness, for the image.
	Image Quality	This setting specifies the overall image quality. Make sure your selection matches the original that you are scanning.
	Exposure Level	This setting specifies the sharpness and clarity of the image. If the "Auto" check box is selected, then the slider bar and edit box are unavailable, and the exposure level is automatically set to the default setting.
	Contrast	This setting specifies the contrast between light and dark areas of the image. This feature cannot be used when [Black & White] is selected in the [Color Settings].
Advanced	Reverse Image	This setting scans images like a photo negative, reversing the black and white areas of the image.
	Prevent Bleed-through	This setting prevents the image on one side of the paper from showing through to the other side when scanned.
Scan Profiles		This is used to check current settings and store frequently used settings. When the [Configuration] button is clicked, a setting screen opens with buttons for [Add], [Edit], and [Delete].
	Add	The current settings can be saved as a Scan Profile.
	Edit	The name and comments of the selected Scan Profile can be changed.
	Delete	Delete saved Scan Profiles.

### 3 Place the originals.

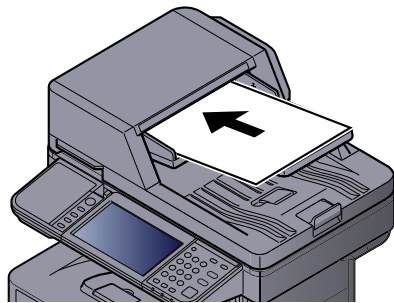

 [Loading Originals \(page 5-2\)](#)



### 4 Scan the originals.

Click the [Scan] button. The document data is scanned.

## Scanning with FMU Connection

"FMU Connection" is installed on the machine as a standard application.

FMU Connection can be used to scan an original according to the settings configured with "File Management Utility" on the provided DVD, and save the image data and scanning information on a specified server or in a specified folder. Unlike regular transmission functions, this application lets you use metadata such as the scan date and time and the data format.

### NOTE

- The first time you use FMU Connection, you must enable it in System Menu. For details, refer to [Application on page 8-23](#).
- To use FMU Connection, you must install File Management Utility on your computer and configure settings for the multifunction machine to be used, scanning conditions, and the file save location. To install File Management Utility, refer to [Installing Software on page 2-20](#).
- For information on using File Management Utility, see **File Management Utility User Guide** on the DVD.

### Using FMU Connection to scan an original

- 1 Make sure that File Management Utility is running on the computer (or server) on which File Management Utility is installed.**
- 2 Place the original.**
- 3 Press [FMU Connection].**  
FMU Connection starts.
- 4 Follow the on-screen instructions to enter the necessary information and press [Next].**
- 5 When the scan settings screen appears, press each item and configure the necessary settings.**  
The features that can be set depend on File Management Utility.
- 6 Press the [Start] key.**  
Sending starts.

## How to use the FAX Function

On products with a FAX function, it is possible to use the FAX function. For details, refer to the **FAX Operation Guide**.

# What is Document Box?

Document Box contains four types of component boxes which provide the following functions.

The following types of document boxes are available.

## Custom Box ([page 5-43](#))

Custom Box is a component box which you can create within the Document Box and store data for later retrieval. You can create or delete a Custom Box, and manipulate data in various ways as described below:



[Creating a New Custom Box \(page 5-43\)](#)

[Storing Documents \(page 5-46\)](#)

[Printing Documents \(page 5-47\)](#)

[Editing Documents \(page 5-48\)](#)

[Deleting Documents \(page 5-49\)](#)



### NOTE

To use Custom Box, an optional SSD must be installed in the machine.

## Job Box

This is a box to save jobs executed from a PC.



### NOTE

- You can set up the machine so that temporary documents in job boxes are automatically deleted. For details, refer to [Deletion of Job Retention on page 8-22](#).
- For details on operating the Job Box, refer to [Printing Data Saved on the Printer on page 4-8](#).

## Private Print/Stored Job Box ([page 4-8](#), [page 4-11](#))

In Private Printing, you can specify that a job is not to be printed until you operate the machine. When sending the job from the application software, specify a 4-digit access code in the printer driver. The job is released for printing by entering the access code on the operation panel, ensuring confidentiality of the print job. The data will be deleted upon completion of the print job or after the power switch is turned off.

In Stored Job, the print data sent from the application is saved to the machine. You can set up an access code as necessary. If you set up an access code, enter the access code when printing. Print data will be stored in the Job Box after printing. This will allow printing of the same print data repeatedly.

## Quick Copy/Proof and Hold Box ([page 4-14](#), [page 4-17](#))

Quick Copy feature facilitates additional prints of a document already printed. Activating Quick Copy and printing a document using the printer driver allow the print data to be stored in the Job Box. When additional copies are required, you can reprint the required number of copies from the operation panel. By default, up to 32 documents can be stored. When power is turned off, all stored jobs will be deleted.



### NOTE

When you attempt to store documents in excess of the above maximum, the oldest document data will be overwritten by the latest document data.

The Proof and Hold feature produces only a single proof print of multiple-print job and holds printing of the remaining copies. Printing a multiple-print job in Proof and Hold using the printer driver allows only a single copy to be printed while maintaining the document data in the Job Box. To continue to print the remaining copies, use the operation panel. You can change the number of copies to print.

## Removable Memory Box ([page 5-50](#))

A USB memory stick can be connected to the USB port on the machine to print a saved PDF file. You can print PDF data directly from the USB memory without a PC. Image files scanned using this machine can also be saved to USB memory in the PDF, TIFF, JPEG, XPS or high compression PDF format (Scan to USB).

## Sub Address Box/Polling Box

Sub Address Box/Polling Box store the fax data. For details, refer to the **FAX Operation Guide**.

# Basic Operation for Document Box

This section explains basic operations for document boxes, using examples where tasks are carried out with custom boxes.

### NOTE

In the following explanation, it is assumed that user box login administration is enabled. For details on User Logon privileges, refer to [Editing and Deleting Custom Box on page 5-45](#).

## Box List



Opens the selected box.

Displays the details for the selected box.

Press [Menu] to search for document boxes (box names/box numbers), change the order of the display (box names/box numbers/owners), register new boxes, change boxes or delete boxes.

## Document List

The document list is a list of the documents stored in the custom box. Documents can be listed either by name or as thumbnails. The list can be used as shown below.

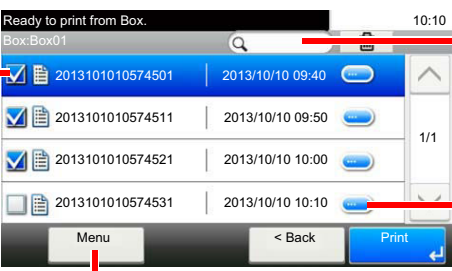

Selecting documents by checking checkboxes.

A document can be searched for by document name.

Display the details for the selected document.

Press [Menu] to print, move, check the details of or delete documents, to select all or cancel all selections or to change the order of the display (name order/time order).

### NOTE

You can select multiple documents by pressing the respective document checkboxes.



# Using a Custom Box

Custom Box is a component box which you can create within the Document Box and store data for later retrieval. You can create or delete a Custom Box, and manipulate data in various ways as described below:

-  [Creating a New Custom Box \(page 5-43\)](#)
- [Storing Documents \(page 5-46\)](#)
- [Printing Documents \(page 5-47\)](#)
- [Editing Documents \(page 5-48\)](#)
- [Deleting Documents \(page 5-49\)](#)

## NOTE

The operation on Custom Box you perform from operation panel can also be made using Command Center RX. For details on Command Center RX, refer to **Command Center RX User Guide**.

## Creating a New Custom Box

### NOTE

- To use Custom Box, an optional SSD must be installed in the machine.
- If user login administration is enabled, you can only change the settings by logging in with administrator privileges. The factory default login user name and login password are set as shown below.

Model Name	Login User Name	Login Password
ECOSYS M3040idn/ECOSYS M3540idn	4000	4000
ECOSYS M3550idn	5000	5000
ECOSYS M3560idn	6000	6000

- If user login administration is enabled, log in with administrator privileges to perform the following operations. They cannot be performed with user privileges.
  - Creating a box
  - Deleting a box of which owner is another user.

## 1 Display the screen.

- 1 Press [Custom Box] on the Home screen.

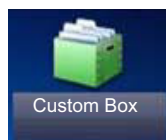

- 2 Press [Menu], [∨], and then [Add].

## 2 Create the Custom Box.

- 1 Enter the box name.  
Up to 32 characters can be entered.

 [Character Entry Method \(page 11-12\)](#)

**2** Check the settings and change or add information as needed.

Item	Description
<b>Box Name</b>	Enter a box name consisting of up to 32 characters. Refer to <a href="#">Character Entry Method on page 11-12</a> for details on entering characters.
<b>Box No.</b>	Enter the box number by pressing [+], [-] or number keys. The box number can be from 0001 to 1000. A Custom Box should have a unique number. If you enter 0000, the smallest number available will be automatically assigned.
<b>Owner*<sup>1</sup></b>	Set the owner of the box. Select the owner from the user list that appears.
<b>Permission*<sup>2</sup></b>	Select whether to share the box.
<b>Box Password</b>	User access to the box can be restricted by specifying a password to protect the box. Entering a password is not mandatory. Enter the same password of up to 16 characters in both [Password] and [Confirm Password]. This can be set if [Shared] is selected in Permission.
<b>Usage Restriction</b>	To preserve the SSD capacity, the storage capacity for a box can be restricted. To enable a capacity restriction enter a value for the storage capacity of the Custom Box in megabytes by pressing [-], [+] or number keys. You can enter a limit between 1 and 30,000 (MB).
<b>Auto File Deletion</b>	Automatically deletes stored documents after a set period of time. Press [On] to enable automatic deletion and then use [+] and [-] or the numeric keys to enter the number of days for which documents are stored. You can enter any number between 1 and 31 (day(s)). To disable automatic file deletion, press [Off].
<b>Free Space</b>	Displays the free space on the box.
<b>Overwrite Setting</b>	Specifies whether or not old stored documents are overwritten when new documents are stored. To overwrite old documents, press [Permit]. To retain old documents, press [Prohibit].
<b>Delete after Printed</b>	Automatically delete a document from the box once printing is complete. To delete the document, press [On]. To retain the document, press [Off].

\*1 Displayed when the user login administration is enabled.

\*2 Not displayed when "Owner" is set to [No Owner].

**3 Press [Save].**

The Custom Box is created.

## Editing and Deleting Custom Box

### 1 Display the screen.

Press [Custom Box] on the Home screen.



### 2 Edit the custom box.

**To edit a custom box**

- 1 Press [Menu], [ √ ], and then [Edit].
- 2 Select the box you want edit.



#### NOTE

- When you have logged in as a user, you can only delete the box whose owner is set to that user.
- When you have logged in as administrator, you can edit all boxes.

When user login administration is enabled, the settings that can be changed varies depending on the privileges of the logged in user.

Privileges	Settings that can be changed
<b>Administrator</b>	Box Name
	Box No.
	Owner
	Permission
	Box Password
	Usage Restriction
	Auto File Deletion
	Overwrite Setting
	Delete after Printed
<b>User</b>	Box Name
	Box Password
	Permission
	Auto File Deletion
	Overwrite Setting
	Delete after Printed

For details, refer to [Creating a New Custom Box on page 5-43](#).

### To delete

- 1 Press [Menu], [ √ ], and then [Delete].
- 2 Select the box you want delete.



#### NOTE

- When you have logged in as a user, you can only delete the box whose owner is set to that user.
- When you have logged in as administrator, you can edit all boxes.

- 3 Press [Delete].
- 4 Press [Yes] in the confirmation screen.

## Storing Documents

Custom box stores the print data which is sent from a PC. Refer to the **Printer Driver User Guide** for the operation of the printing from the PC.

## Printing Documents

The procedure for printing documents in a custom box is explained below.

### 1 Display the screen.

- 1 Press [Custom Box] on the Home screen.



- 2 Select the box containing the document you want to print.



#### NOTE

If a custom box is protected by a password, enter the correct password.

### 2 Print the document.

- 1 Select the document you wish to print by checking the checkbox.

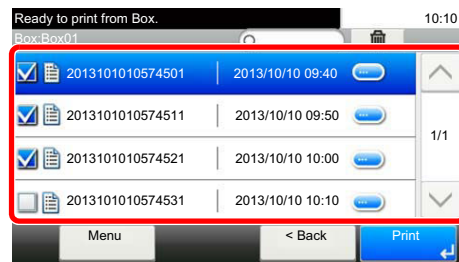

The document is marked with a checkmark.



#### NOTE

To deselect, press the checkbox again and remove the checkmark.

- 2 Press [Print].
- 3 The print settings selection screen appears.  
 To use the settings used at the time of printing (when the document was saved), press [Print As Is], enter the print quantity, and press [OK] to start printing.  
 To change the print settings, press [Print after Change Settings] and proceed to next step.
- 4 Set the paper selection, duplex printing, etc., as desired.  
 For the features that can be selected, refer to [Custom Box \(Printing\) \(page 6-5\)](#).
- 5 Press the [Start] key. Printing of the selected document begins.

## Editing Documents

This function allows you to move documents stored in custom boxes into other boxes. The procedure for moving documents is explained below.

### 1 Display the screen.

- 1 Press [Custom Box] on the Home screen.



- 2 Select the box containing the document you want to move.



#### NOTE

If a custom box is protected by a password, enter the correct password.

### 2 Move documents.

- 1 Select the document in the list that you want to move by pressing the checkbox.

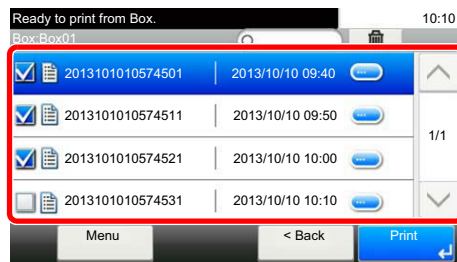

The document is marked with a checkmark.



#### NOTE

To deselect, press the checkbox again and remove the checkmark.

- 2 Press [Menu] and then [Move to Another Custom Box].

- 3 Select the destination of move.



- 4 Press [Select This Folder] and then press [Yes] in the confirmation screen.

The selected document is moved.



#### NOTE

If the box to which the document is to be moved is protected by a password, enter the correct password.

## Deleting Documents

The procedure for deleting documents in a custom box is explained below.

### 1 Display the screen.

- 1 Press [Custom Box] on the Home screen.



- 2 Select the box containing the document you want to delete.



#### NOTE

If a custom box is protected by a password, enter the correct password.

### 2 Delete the document.

- 1 Select the document you wish to delete by checking the checkbox.

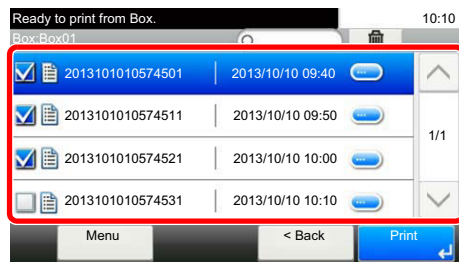

The document is marked with a checkmark.



#### NOTE

- [  ] is disabled until a document is selected.
- To deselect, press the checkbox again and remove the checkmark.

- 2 Press [  ].

The delete confirmation screen appears.

- 3 Press [Yes].

The document is deleted.

# Printing Documents Stored in Removable USB Memory

Plugging USB memory directly into the machine enables you to quickly and easily print the files stored in the USB memory without having to use a computer.

The following file types can be printed:

- PDF file (Version 1.7 or older)
- TIFF file (TIFF V6/TTN2 format)
- JPEG file
- XPS file
- Encrypted PDF file
- PDF files you wish to print should have an extension (.pdf).
- Files to be printed should be saved no further down than the top 3 folder levels, including the root folder.
- Use USB memory properly formatted by this machine.
- Plug the USB memory directly into the USB Port.

## 1 Plug the USB memory.

- 1 Plug the USB memory into the USB Memory Slot.

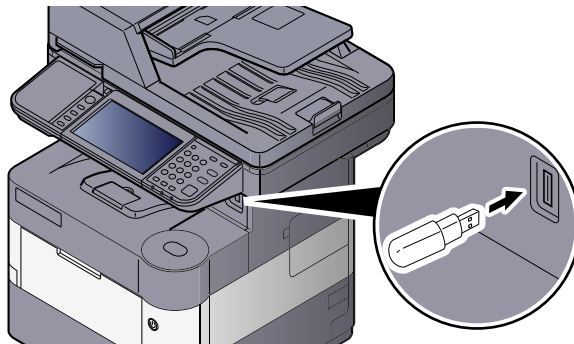

- 2 When the machine reads the USB memory, "Removable Memory is recognized. Displaying files. Are you sure?" may appear. Press [Yes].

Displays the removable memory screen.

### ✔ IMPORTANT

**Use USB memory properly formatted by this machine. If a USB memory formatted by any other device is used, "The removable memory is not formatted." may appear. To format the USB memory, refer to [Device/Communication on page 7-13](#).**

### 📘 NOTE

If the message does not appear, press [Removable Memory] on the Home screen.



## 2 Print the document.

- 1 Select the folder containing the file to be printed and press [Open].

The machine will display documents in the top 3 folder levels, including the root folder.

### NOTE

1,000 documents can be displayed.

To return to a higher level folder, press [Up].

- 2 Select the file to be printed and press [Print].

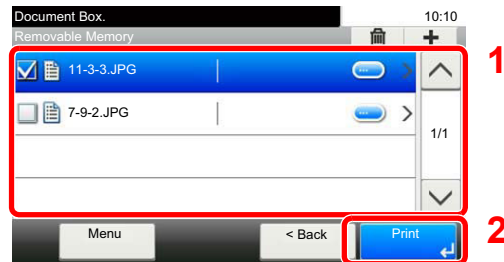

- 3 Change the number of copies, duplex printing, etc. as desired.

For the features that can be selected, refer to [Removable Memory \(Store File, Printing Documents\)](#) (page 6-6).

- 4 Press the [Start] key.

Printing of the selected file begins.

# Saving Documents to USB Memory (Scan to USB)

This function allows you to store scanned image files in USB memory connected to the machine. You can store files in PDF, TIFF, JPEG, XPS or high-compression PDF format.

## NOTE

The maximum number of the storable files is 1,000.

## 1 Place the originals.

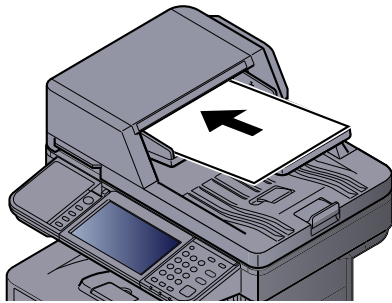

 Refer to [Loading Originals on page 5-2](#).

## 2 Plug the USB memory.

- 1 Plug the USB memory into the USB Memory Slot.

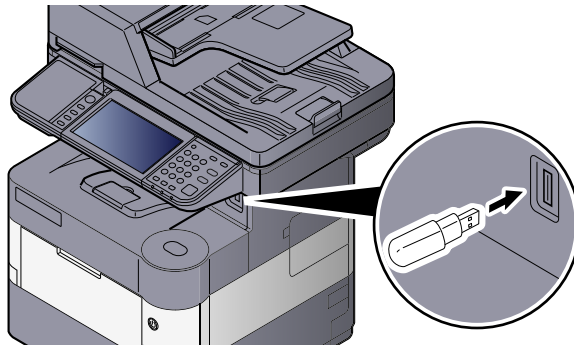

- 2 When the machine reads the USB memory, "Removable Memory is recognized. Displaying files. Are you sure?" may appear. Press [Yes] to display the removable memory screen.

### IMPORTANT

- Use USB memory properly formatted by this machine. If a USB memory formatted by any other device is used, "The removable memory is not formatted." may appear. To format the USB memory, refer to [Device/Communication on page 7-13](#).
- When [Format] is pressed, all data in the external media is erased.

### NOTE

If the message does not appear, press [Removable Memory] on the Home screen.

### 3 Store the document.

- 1 Select the folder where the file will be stored.

The machine will display the top 3 folder levels, including the root folder.

- 2 Press [+].



- 3 Set the type of original, file format, etc., as desired.

For the features that can be set, refer to [Removable Memory \(Store File, Printing Documents\) \(page 6-6\)](#).

- 4 Press the [Start] key.

The original is scanned and the data is stored in the USB memory.

## Check the USB Memory Information

You can check the USB memory information.

In the removable memory screen, press [Menu], [∨], and then [Memory Information].



Once you confirm the information, press [Close].

# Removing USB Memory

Follow the steps below to remove the USB memory.

**IMPORTANT**

Be sure to follow the proper procedure to avoid damaging the data or USB memory.

## 1 Display the screen.

- 1 Press [Removable Memory] on the Home screen.



## 2 Press [Menu], [∨], and then [Remove Memory].



Press [OK], and remove the USB memory after "Removable Memory can be safely removed." is displayed.



### NOTE

USB memory can also be removed after checking the status of the device. Refer to [Device/Communication on page 7-13](#).

# 6 Using Various Functions

This chapter explains the following topics:

Functions Available on the Machine .....	6-2
Copy .....	6-2
Send .....	6-3
Custom Box (Printing) .....	6-5
Removable Memory (Store File, Printing Documents) .....	6-6
Functions .....	6-8
Original Size .....	6-8
Paper Selection .....	6-9
Original Orientation .....	6-10
Collate .....	6-10
Density .....	6-11
Original Image .....	6-11
EcoPrint .....	6-12
Color Selection .....	6-12
Sharpness .....	6-13
Background Density Adj. (Background Density Adjustment) .....	6-13
Prevent Bleed-thru .....	6-14
Zoom .....	6-14
Combine .....	6-16
Duplex .....	6-18
Continuous Scan .....	6-19
Job Finish Notice .....	6-20
File Name Entry .....	6-21
Priority Override .....	6-21
Quiet Mode .....	6-21
Duplex (2-sided Original) .....	6-22
Sending Size .....	6-23
File Format .....	6-24
File Separation .....	6-27
Scan Resolution .....	6-27
E-mail Subject/Body .....	6-27
FTP Encrypted TX .....	6-28
Delete after Printed .....	6-28
Storing Size .....	6-29
Encrypted PDF Password .....	6-29
JPEG/TIFF Print .....	6-30
XPS Fit to Page .....	6-30

# Functions Available on the Machine

## Copy

To configure the settings for functions, press the function key. By pressing [Functions], other selectable functions will be shown as a list.

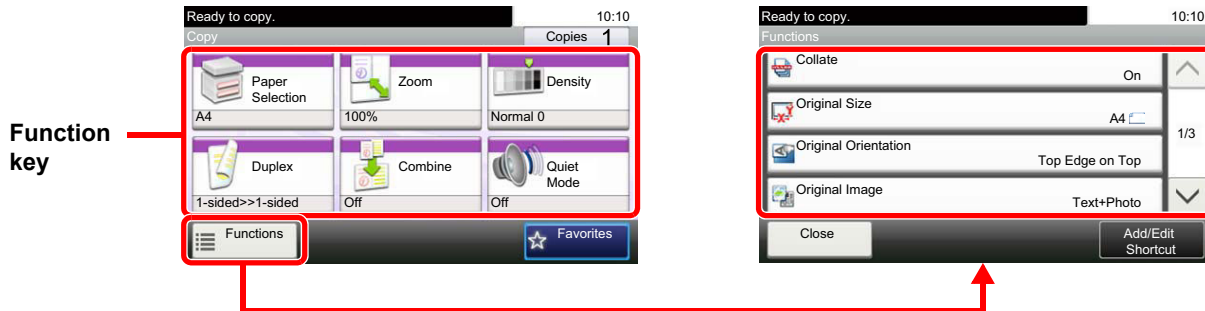

For details on each function, see the table below.

Function key	Description	Reference page
<b>Paper Selection</b>	Select the cassette or multi-purpose tray that contains the required paper size.	<a href="#">page 6-9</a>
<b>Zoom</b>	Adjusts the zoom to reduce or enlarge the image.	<a href="#">page 6-14</a>
<b>Density</b>	Adjust density using 9 levels.	<a href="#">page 6-11</a>
<b>Duplex</b>	Produces two-sided copies.	<a href="#">page 6-18</a>
<b>Combine</b>	Combines 2 or 4 original sheets into 1 printed page.	<a href="#">page 6-16</a>
<b>Quiet Mode</b>	Lower print and scan speed for quiet processing.	<a href="#">page 6-21</a>

Functions	Description	Reference page
<b>Collate</b>	Offsets the output by page or set.	<a href="#">page 6-10</a>
<b>Original Size</b>	Specify the original size to be scanned.	<a href="#">page 6-8</a>
<b>Original Orientation</b>	Select the orientation of the original document top edge to scan correct direction.	<a href="#">page 6-10</a>
<b>Original Image</b>	Select original image type for best results.	<a href="#">page 6-11</a>
<b>EcoPrint</b>	EcoPrint saves toner when printing.	<a href="#">page 6-12</a>
<b>Sharpness</b>	Adjusts the sharpness of image outlines.	<a href="#">page 6-13</a>
<b>Background Density Adj.</b>	Removes dark background from originals, such as newspapers.	<a href="#">page 6-13</a>
<b>Prevent Bleed-thru</b>	Hides background colors and image bleed-through when scanning thin original.	<a href="#">page 6-14</a>
<b>Continuous Scan</b>	Scans a large number of originals in separate batches and then produce as one job.	<a href="#">page 6-19</a>
<b>Job Finish Notice</b>	Sends E-mail notice when a job is complete.	<a href="#">page 6-20</a>
<b>File Name Entry</b>	Adds a file name.	<a href="#">page 6-21</a>
<b>Priority Override</b>	Suspends the current job and gives a new job top priority.	<a href="#">page 6-21</a>

## Send

To configure the settings for functions, press [Functions].

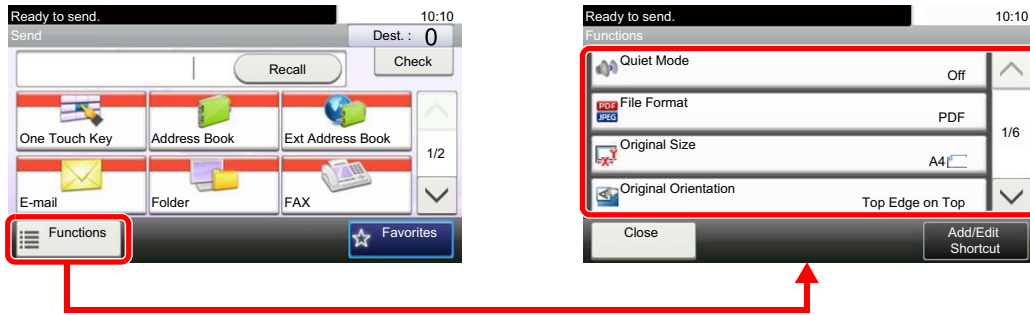

For details on each function, see the table below.

Functions	Description	Reference page
<b>Quiet Mode</b>	Lower print and scan speed for quiet processing.	<a href="#">page 6-21</a>
<b>File Format</b>	Specify the image file format. Image quality level can also be adjusted.	<a href="#">page 6-24</a>
<b>Original Size</b>	Specify the original size to be scanned.	<a href="#">page 6-8</a>
<b>Original Orientation</b>	Select the orientation of the original document top edge to scan correct direction.	<a href="#">page 6-10</a>
<b>Duplex</b>	Select the type and orientation of the binding based on the original.	<a href="#">page 6-22</a>
<b>Sending Size</b>	Select size of image to be sent.	<a href="#">page 6-23</a>
<b>File Separation</b>	Creates several files by dividing scanned original data page by page before sending the files.	<a href="#">page 6-27</a>
<b>Scan Resolution</b>	Select fineness of scanning resolution.	<a href="#">page 6-27</a>
<b>Density</b>	Adjust density using 9 levels.	<a href="#">page 6-11</a>
<b>Color Selection</b>	Select the color mode setting.	<a href="#">page 6-12</a>
<b>Original Image</b>	Select original image type for best results.	<a href="#">page 6-11</a>
<b>Sharpness</b>	Adjusts the sharpness of image outlines.	<a href="#">page 6-13</a>
<b>Background Density Adj.</b>	Removes dark background from originals, such as newspapers.	<a href="#">page 6-13</a>
<b>Prevent Bleed-thru</b>	Hides background colors and image bleed-through when scanning thin original.	<a href="#">page 6-14</a>
<b>FAX TX Resolution</b>	Select fineness of images when sending FAX.	Refer to the <b>FAX Operation Guide</b> .
<b>Zoom</b>	Adjusts the zoom to reduce or enlarge the image.	<a href="#">page 6-14</a>
<b>Continuous Scan</b>	Scans a large number of originals in separate batches and then produce as one job.	<a href="#">page 6-19</a>
<b>File Name Entry</b>	Adds a file name.	<a href="#">page 6-21</a>
<b>E-mail Subject/Body</b>	Adds subject and body when sending a document.	<a href="#">page 6-27</a>
<b>Job Finish Notice</b>	Sends E-mail notice when a job is complete.	<a href="#">page 6-20</a>
<b>FTP Encrypted TX</b>	Encrypts images when sending via FTP.	<a href="#">page 6-28</a>
<b>FAX Delayed Transmission</b>	Set a send time.	Refer to the <b>FAX Operation Guide</b> .

Functions	Description	Reference page
<b>FAX Direct Transmission</b>	Sends FAX directly without reading original data into memory.	Refer to the <b>FAX Operation Guide</b> .
<b>FAX Polling RX</b>	Automatically makes a machine with a stored document send the document to your machine.	Refer to the <b>FAX Operation Guide</b> .
<b>FAX TX Report</b>	Prints a report when transmission of a document is successful, or when an error occurs and transmission fails.	Refer to the <b>FAX Operation Guide</b> .



## Custom Box (Printing)

To configure the settings for functions, press the function key. By pressing [Functions], other selectable functions will be shown as a list.



For details on each function, see the table below.

Function key	Description	Reference page
<b>Paper Selection</b>	Select the cassette or multi-purpose tray that contains the required paper size.	<a href="#">page 6-9</a>
<b>Collate</b>	Offsets the output by page or set.	<a href="#">page 6-10</a>
<b>Duplex</b>	Produces two-sided copies.	<a href="#">page 6-18</a>
<b>Delete after Printed</b>	Automatically deletes a document from the box once printing is complete.	<a href="#">page 6-28</a>
<b>Quiet Mode</b>	Lower print and scan speed for quiet processing.	<a href="#">page 6-21</a>

Functions	Description	Reference page
<b>Priority Override</b>	Suspends the current job and gives a new job top priority.	<a href="#">page 6-21</a>
<b>File Name Entry</b>	Adds a file name.	<a href="#">page 6-21</a>
<b>Job Finish Notice</b>	Sends E-mail notice when a job is complete.	<a href="#">page 6-20</a>
<b>EcoPrint</b>	EcoPrint saves toner when printing.	<a href="#">page 6-12</a>

## Removable Memory (Store File, Printing Documents)

To configure the settings for functions, press the function key. By pressing [Functions], other selectable functions will be shown as a list.

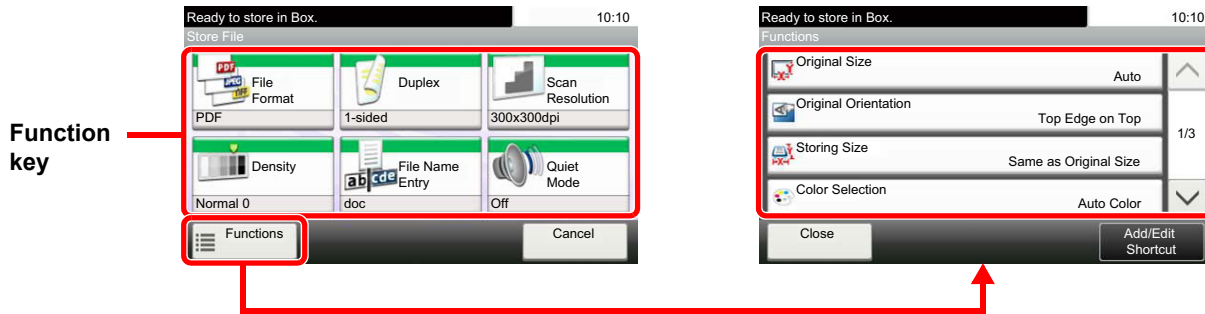

For details on each function, see the table below.

### Store File

Function key	Description	Reference page
<b>File Format</b>	Specify the image file format. Image quality level can also be adjusted.	<a href="#">page 6-24</a>
<b>Duplex</b>	Select the type and orientation of the binding based on the original.	<a href="#">page 6-22</a>
<b>Scan Resolution</b>	Select fineness of scanning resolution.	<a href="#">page 6-27</a>
<b>Density</b>	Adjust density using 9 levels.	<a href="#">page 6-11</a>
<b>File Name Entry</b>	Adds a file name.	<a href="#">page 6-21</a>
<b>Quiet Mode</b>	Lower print and scan speed for quiet processing.	<a href="#">page 6-21</a>

Functions	Description	Reference page
<b>Original Size</b>	Specify the original size to be scanned.	<a href="#">page 6-8</a>
<b>Original Orientation</b>	Select the orientation of the original document top edge to scan correct direction.	<a href="#">page 6-10</a>
<b>Storing Size</b>	Select size of image to be stored.	<a href="#">page 6-29</a>
<b>Color Selection</b>	Select the color mode setting.	<a href="#">page 6-12</a>
<b>Original Image</b>	Select original image type for best results.	<a href="#">page 6-11</a>
<b>Sharpness</b>	Adjusts the sharpness of image outlines.	<a href="#">page 6-13</a>
<b>Background Density Adj.</b>	Removes dark background from originals, such as newspapers.	<a href="#">page 6-13</a>
<b>Prevent Bleed-thru</b>	Hides background colors and image bleed-through when scanning thin original.	<a href="#">page 6-14</a>
<b>Zoom</b>	Adjusts the zoom to reduce or enlarge the image.	<a href="#">page 6-14</a>
<b>Continuous Scan</b>	Scans a large number of originals in separate batches and then produce as one job.	<a href="#">page 6-19</a>
<b>Job Finish Notice</b>	Sends E-mail notice when a job is complete.	<a href="#">page 6-20</a>
<b>File Separation</b>	Creates several files by dividing scanned original data page by page before sending the files.	<a href="#">page 6-27</a>

## Printing Documents

Function key	Description	Reference page
<b>Paper Selection</b>	Select the cassette or multi-purpose tray that contains the required paper size.	<a href="#">page 6-9</a>
<b>Collate</b>	Offsets the output by page or set.	<a href="#">page 6-10</a>
<b>Duplex</b>	Produces two-sided copies.	<a href="#">page 6-18</a>
<b>Quiet Mode</b>	Lower print and scan speed for quiet processing.	<a href="#">page 6-21</a>

Functions	Description	Reference page
<b>EcoPrint</b>	EcoPrint saves toner when printing.	<a href="#">page 6-12</a>
<b>Job Finish Notice</b>	Sends E-mail notice when a job is complete.	<a href="#">page 6-20</a>
<b>Priority Override</b>	Suspends the current job and gives a new job top priority.	<a href="#">page 6-21</a>
<b>Encrypted PDF Password</b>	Enter the preassigned password to print the PDF data.	<a href="#">page 6-29</a>
<b>JPEG/TIFF Print</b>	Select the image size when printing JPEG or TIFF files.	<a href="#">page 6-30</a>
<b>XPS Fit to Page</b>	Reduces or enlarges the image size to fit to the selected paper size when printing XPS file.	<a href="#">page 6-30</a>

# Functions

## Original Size



Specify the original size to be scanned. Press [Metric], [Inch], or [Others] to select the original size.

Item	Value	Description
<b>Metric</b>	A4-R, A5-R, A6-R, B5-R, B6-R, Folio, 216 × 340 mm	Select from the Metric standard sizes.
<b>Inch</b>	Letter-R, Legal, Statement-R, Executive, Oficio II	Select from the Inch series standard sizes.
<b>Others</b>	16K-R, ISO B5, Envelope #10, Envelope #9, Envelope #6, Envelope Monarch, Envelope DL, Envelope C5, Hagaki, Oufuku Hagaki, Youkei 4, Youkei 2, Custom <sup>*1</sup>	Select from special standard sizes and custom sizes.

\*1 For instructions on how to specify the custom original size, refer to [Custom Original Size on page 8-12](#).



### NOTE

Be sure to always specify the original size when using custom size original.

## Paper Selection



Select the cassette or multi-purpose tray that contains the required paper size.

Select from [1] (Cassette 1) to [5] (Cassette 5) to use the paper contained in that cassette.

If [Auto] is selected, the paper matching the size of the original is selected automatically.



### NOTE

- Specify in advance the size and type of the paper loaded in the cassette (refer to [Cassette/MP Tray Settings on page 8-9](#)).
- Cassettes 2 to 5 are displayed when the optional paper feeder is installed.

To select [MP tray], press [Paper Size] and [Media Type], and specify the paper size and the media type. The available paper sizes and media types are shown in the table below.

Item		Value	Description
Paper Size	Metric	A4-R, A5-R, A6-R, B5-R, B6-R, Folio, 216 × 340 mm	Select from the Metric standard sizes.
	Inch	Letter-R, Legal, Statement-R, Executive, Oficio II	Select from the Inch series standard sizes.
	Others	16K-R, ISO B5, Envelope #10, Envelope #9, Envelope #6, Envelope Monarch, Envelope DL, Envelope C5, Hagaki, Oufuku Hagaki, Youkei 4, Youkei 2, Custom* <sup>1</sup>	Select from special standard sizes and custom sizes.
	Size Entry	Metric X: 70 to 216 mm (in 1 mm increments) Y: 148 to 356 mm (in 1 mm increments) Inch X: 2.76 to 8.50" (in 0.01" increments) Y: 5.83 to 14.02" (in 0.01" increments)	Enter the size not included in the standard size.* <sup>2</sup> When you have selected [Size Entry], use [+] / [-] or the numeric keys to set the sizes of "X" (horizontal) and "Y" (vertical).
Media type		Plain (60 to 105 g/m <sup>2</sup> ) Transparency, Rough, Vellum (60 to 63 g/m <sup>2</sup> ), Labels, Recycled, Preprinted* <sup>3</sup> , Bond, Cardstock, Color, Prepunched* <sup>3</sup> , Letterhead* <sup>3</sup> , Envelope, Thick (106 to 220 g/m <sup>2</sup> ), High Quality, Custom 1-8* <sup>3</sup>	

\*1 For instructions on how to specify the custom paper size, refer to [Custom Paper Size on page 8-13](#).

\*2 The input units can be changed in System Menu. For details, refer to [Measurement on page 8-17](#).

\*3 For instructions on how to specify the custom paper types 1 to 8, refer to [Media Type Setting on page 8-14](#). To print on preprinted or prepunched paper or on letterhead, refer to [Special Paper Action on page 8-14](#).



### NOTE

- You can conveniently select in advance the size and type of paper that will be used often and set them as default (refer to [Multi Purpose Tray on page 8-10](#)).
- If the specified size of paper is not loaded in the paper source cassette or multi purpose tray, a confirmation screen appears.

## Original Orientation





Select the orientation of the original document top edge to scan correct direction.

To use any of the following functions, the document's original orientation must be set.

- Duplex
- Combine
- Duplex (Original)

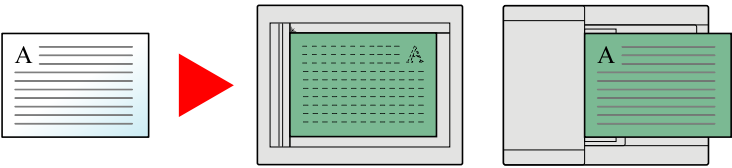
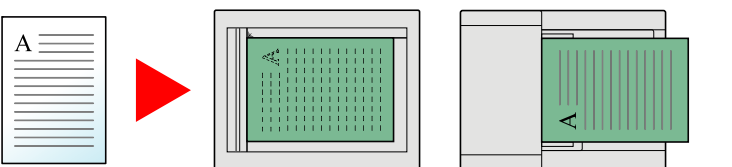
Select original orientation from [Top Edge on Top] or [Top Edge on Left].

Item	Image
<p><b>Top Edge on Top</b></p>	 <p>Original                      Original orientation</p>
<p><b>Top Edge on Left</b></p>	 <p>Original                      Original orientation</p>

 **NOTE**

The default setting for Original Orientation can be changed. Refer to [Original Orientation on page 8-15](#) for details.

## Collate



Offsets the output by page or set.

(Value: [Off] / [On])



## Density



Adjust density using 9 levels.

Adjust density pressing [-4] (Lighter) to [+4] (Darker).



## Original Image



Select original image type for best results.

### Copying/Printing

Item	Description
<b>Text+Photo</b> <sup>*1</sup>	Best for mixed text and photo documents.
<b>Photo</b>	Best for photos taken with a camera.
<b>Text</b>	Best for documents that are mostly text
<b>Light Text/Fine Line</b>	Clearly reproduces faint characters written in pencil, etc., and thin lines on map originals or diagrams.

\*1 If gray text is not printed completely using [Text + Photo], selecting [Text] may improve the result.

### Sending/Storing

Item	Description
<b>Text+Photo</b>	Best for mixed text and photo documents.
<b>Photo</b>	Best for photos taken with a camera.
<b>Text</b>	Best for documents that are mostly text
<b>Light Text/Fine Line</b>	Clearly reproduces faint characters written in pencil, etc., and thin lines on map originals or diagrams.
<b>Text (for OCR)</b> <sup>*1</sup>	Scanning produces an image that is suitable for OCR.

\*1 This function is only available when "Color Selection" is set to [Black & White]. For details, refer to [Color Selection on page 6-12](#).

## EcoPrint

Copy

Print from  
BoxPrint from  
USB

EcoPrint saves toner when printing. Use this function for test prints or any other occasion when high quality print is not required.

(Value: [Off] / [On])

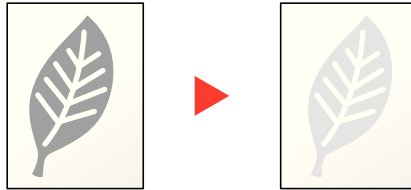

## Color Selection

Send

Scan to  
USB

Select the color mode setting.

Item	Description
<b>Auto (Color/Gray)</b>	Automatically recognizes whether the document is color or black and white, and scan color documents in Full Color and black and white documents in Grayscale.
<b>Auto (Color/B &amp; W)</b>	Automatically recognizes whether the document is color or black and white, and scan color documents in Full Color and black and white documents in Black and White.
<b>Full Color</b>	Scans the document in full color.
<b>Grayscale</b>	Scans the document in grayscale. Produces a smooth, detailed image.
<b>Black &amp; White</b>	Scans the document in black and white.



## Sharpness



Adjusts the sharpness of image outlines.

When copying penciled originals with rough or broken lines, clear copies can be taken by adjusting sharpness toward "Sharpen". When copying images made up of patterned dots such as magazine photos, in which moire<sup>\*1</sup> patterns appear, edge softening and weakening of the moire effect can be obtained by setting the sharpness toward "Blur".

Less Sharp



Original



More Sharp

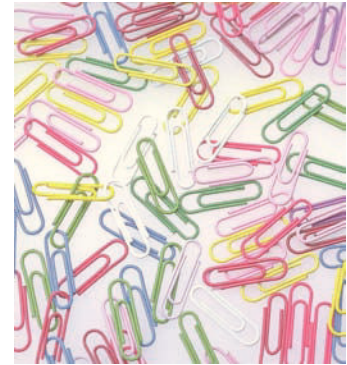

Item	Description
1 to 3 (Sharpen)	Emphasizes the image outline.
-1 to -3 (Blur)	Blurs the image outline. Can weaken a Moire <sup>*1</sup> effect.

\*1 Patterns that are created by irregular distribution of halftone dots.

## Background Density Adj. (Background Density Adjustment)



Removes dark background from originals, such as newspapers. This feature is used with full color and auto color. Background Density Adjustment is disabled if Auto Color detects black and white originals.

If the ground color is obtrusive, select [Auto]. If [Auto] does not remove the ground color, select [Manual] and adjust the density of the ground color.

Item	Description
Off	Does not adjust the ground color.
Auto	Automatically adjusts the background density based on the original.
Manual	Manually adjust the density in 5 levels. When [Manual] is selected, press [1] to [5] (Lighter - Darker) to adjust the background density.

## Prevent Bleed-thru



Hides background colors and image bleed-through when scanning thin original.

(Value: [Off] / [On])

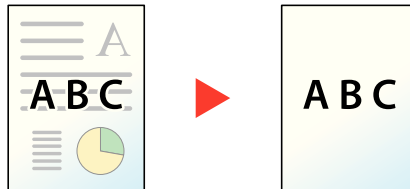

## Zoom



Adjust the zoom to reduce or enlarge the image.

### Copying

The following zoom options are available.

#### Auto

Adjusts the image to match the paper size.

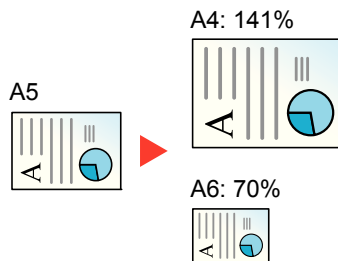

#### Standard Zoom

Reduces or enlarges at preset magnifications.

Model	Zoom Level (Original Copy)		Model	Zoom Level (Original Copy)	
Metric Models	400%	90% FOL >> A4	Inch Models	400%	78% LGL >> LTR
	200%	70%		200%	64% LTR >> STMT
	141% A5 >> A4	50%		129% STMT >> LTR	50%
	100%	25%		100%	25%

#### Others

Reduces or enlarges at magnifications other than the Standard Zoom.

Model	Zoom Level (Original Copy)		Model	Zoom Level (Original Copy)	
Metric Models	115% B5 >> A4	78% LGL >> LTR	Inch Models	141% A5 >> A4	86% A4 >> B5
	86% A4 >> B5	64% LTR >> STMT		115% B5 >> A4	70% A4 >> A5
	129% STMT >> LTR			90% FOL >> A4	

## Zoom Entry

Manually reduces or enlarges the original image in 1% increments between 25% and 400%. Use the numeric keys or press [+] or [-] to enter the any magnification.

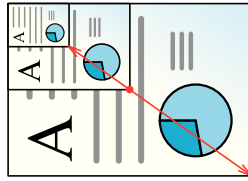

## Printing/Sending/Storing

Item	Description
100%	Reproduces the original size.
Auto	Reduces or enlarges original to printing/sending/storing size.



### NOTE

To reduce or enlarge the image, select the paper size, sending size, or storing size.



[Paper Selection \(page 6-9\)](#)

[Sending Size \(page 6-23\)](#)

[Storing Size \(page 6-29\)](#)

# Combine



Combines 2 or 4 original sheets into 1 printed page. You can select the page layout and the type of boundary lines around the pages.

The following types of the boundary lines are available.

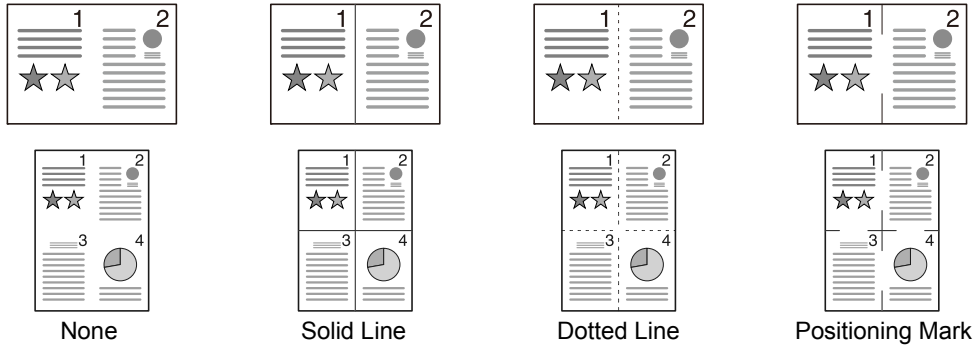

Item		Value	Description
<b>Off</b>		—	Disables the function.
<b>2 in 1</b>		—	Copy the original with the default setting. For the default settings, refer to <a href="#">Function Defaults on page 8-15</a> .
<b>4 in 1</b>		—	
<b>Others</b>	<b>Combine</b>	Off, 2 in 1 (L to R/T to B), 2 in 1 (R to L/B to T), 4 in 1 (Right then Down), 4 in 1 (Left then Down), 4 in 1 (Down then Right), 4 in 1 (Down then Left)	Select the page layout of scanned originals.
	<b>Border Line</b>	None, Solid Line, Dotted Line, Positioning Mark	Select the boundary line type.
	<b>Original Orientation</b>	Top Edge on Top, Top Edge on Left	Select the orientation of the original document top edge to scan correct direction.

## Layout image

Item		Image
<b>2 in 1</b>	<b>L to R/T to B</b>	
	<b>R to L/B to T</b>	

Item		Image
4 in 1	Right then Down	
	Left then Down	
	Down then Right	
	Down then Left	



**NOTE**

- The paper sizes supported in Combine mode are A4, A5, B5, Folio, 216 × 340 mm, Letter, Legal, Statement, Oficio II, and 16K.
- When placing the original on the platen, be sure to copy the originals in page order.

# Duplex



Produces two-sided copies.

The following modes are available.

## One-sided to Two-sided

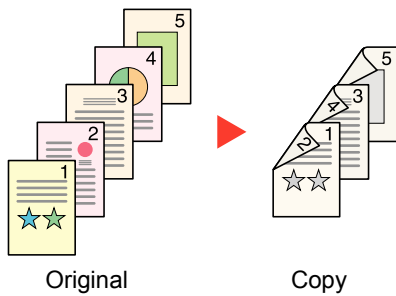

Produces two-sided copies from one-sided originals. In case of an odd number of originals, the back side of the last copy will be blank.

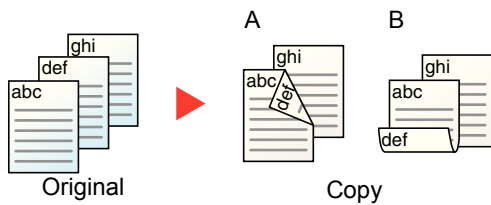

The following binding options are available.

- A Original Left/Right to Binding Left/Right: Images on the second sides are not rotated.
- B Original Left/Right to Binding Top: Images on the second sides are rotated 180 degrees. Copies can be bound on the top edge, facing the same orientation when turning the pages.

## Two-sided to One-sided

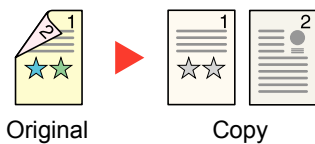

Copies each side of a two-sided original onto two individual sheets.

The following binding options are available.

- Binding Left/Right: Images on the second sides are not rotated.
- Binding Top: Images on the second sides are rotated 180 degrees.

## Two-sided to Two-sided

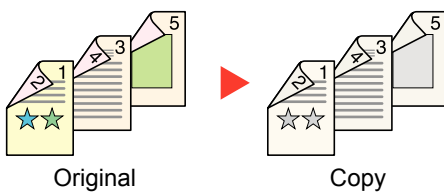

Produces two-sided copies from two-sided originals.

### NOTE

The paper sizes supported in Two-sided to Two-sided mode are A4, B5, A5, Legal, Letter, Executive, Statement, Oficio II, 216 × 340 mm, Folio, Envelope C5, and 16K.

## Copying

Prints 1-sided originals to 2-sided, or 2-sided originals to 1-sided. Select the binding orientation for original and finished documents.

Item		Value	Description
1-sided>>1-sided		—	Disables the function.
1-sided>>2-sided		—	Copy the original with the default setting. For the default settings, refer to <a href="#">Function Defaults on page 8-15</a> .
2-sided>>1-sided		—	
2-sided>>2-sided		—	
Others	Duplex	1-sided>>1-sided, 1-sided>>2-sided, 2-sided>>1-sided, 2-sided>>2-sided	Select the desired duplex option.
	Binding in Original <sup>*1</sup>	Left/Right, Top	Select the binding orientation of originals.
	Binding in Finishing <sup>*2</sup>	Left/Right, Top	Select the binding orientation of copies.
	Original Orientation	Top Edge on Top, Top Edge on Left	Select the orientation of the original document top edge to scan correct direction.

\*1 Displayed when [2-sided>>1-sided] or [2-sided>>2-sided] is selected for "Duplex".



\*2 Displayed when [1-sided>>2-sided] or [2-sided>>2-sided] is selected for "Duplex".

When placing the original on the platen, consecutively replace each original and press the **[Start]** key.

After scanning all originals, press [Finish Scan] to start copying.

## Printing

Print a document to 1-sided or 2-sided sheets.

Item	Description
1-sided	Disables the function.
 2-sided	Prints a 2-sided document so that the sheets are aligned properly for binding on the left or right.
 2-sided	Prints a 2-sided document so that the sheets are aligned properly for binding on the top.

## Continuous Scan



Scans a large number of originals in separate batches and then produce as one job. Originals will be scanned continuously until you press [Finish Scan].

(Value: [Off] / [On])

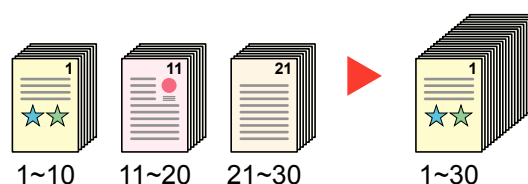

## Job Finish Notice



Sends E-mail notice when a job is complete.

Users can be notified of the completion of a job while working at a remote desk, saving the time spent waiting beside the machine to finish.



### Example of Job Finish Notice:

To:	h_pttr@owl-net.net
Subject:	1234 Job end report mail
Job No.:	000002
Result:	OK
End Time:	Sat 02 Feb 2013 10:10:10
File Name:	doc27042005145608
Job Type:	Copy
1234	
[00:c0:ee:d0:01:14]	



### NOTE

- PC should be configured in advance so that E-mail can be used. For details, refer to [Command Center RX on page 2-34](#).
- E-mail can be sent to a single destination.

Item	Description
Off	Disables the function.
On	Displays the destination list.
	<b>Add a Destination</b> To add a new destination, press [ + ]. <ul style="list-style-type: none"> <li>• <b>Address Book</b>: Select the notification destination from the address book and press [OK].</li> <li>• <b>Ext. Address Book</b><sup>*1</sup>: Select the notification destination from the external address book</li> <li>• <b>Address Entry</b>: Enter the e-mail address directly. Enter the address (up to 128 characters) and press [OK].</li> <li>• <b>My Address</b><sup>*2</sup>: Uses the e-mail address of the logged in user.</li> </ul>
	<b>Check the Destination</b> To display details for the destinations, press [  ].
	<b>Delete the Destination</b> To delete the selected destination, press [  ].

\*1 For details on the External Address Book, refer to **Command Center RX User Guide**.

\*2 Displayed when user login administration is enabled.



## File Name Entry



Adds a file name. Additional information such as job number and date and time can also be set. You can check a job history or job status using the file name, date and time, or job number specified here.

Enter the file name (up to 32 characters), and press [Next].

To add date and time, press [Date and Time]. To add job number, press [Job No.]. To add both, select [Job No. + Date] or [Date + Job No.].

## Priority Override



Suspends the current job and gives a new job top priority. The suspended job resumes after the other job is finished.

(Value: [Off] / [On])



### NOTE

- This function is not available if current job was an override.
- Priority override may not be available depending on the status of the current print job and memory usage.

## Quiet Mode



Lower print and scan speed for quiet processing. Select this mode when the running noise is uncomfortable.

It is possible to set the use of Quiet Mode for each function, such as copying and sending.

(Value: [Off] / [On])



### NOTE

- The processing speed will be slower than normal when in Quiet Mode.
- This cannot be used when [Prohibit] is set for [Specify for Each Job on page 8-40](#).

## Duplex (2-sided Original)

Send



Scan to  
USB

Select the type and orientation of the binding based on the original.

Item		Value	Description
<b>1-sided</b>		—	Disables the function.
<b>2-sided</b>		—	Set when using a 2-sided sheet original that will be bound on the left or right.
<b>Others</b>	<b>Duplex</b>	1-sided, 2-sided (Binding Left/Right), 2-sided (Binding Top)	Select the binding orientation of originals.
	<b>Original Orientation</b> *1	Top Edge on Top, Top Edge on Left	Select the orientation of the original document top edge to scan correct direction.

\*1 Displayed when [2-sided (Binding Left/Right)] or [2-sided (Binding Top)] is selected in "Duplex".

### Sample image

Value		Image
<b>2-sided</b>	<b>Binding Left/Right</b>	
	<b>Binding Top</b>	

## Sending Size



Select size of image to be sent.

Press [Same as Original Size], [Metric], [Inch], or [Others] to select the sending size.

Item	Value	Description
<b>Same as Original Size</b>	—	Automatically sends the same size as the original.
<b>Metric</b>	A4, A5, A6, B5, B6, Folio, 216 × 340 mm	Select from the Metric standard sizes.
<b>Inch</b>	Letter, Legal, Statement, Executive, Oficio II	Select from the Inch series standard sizes.
<b>Others</b>	16K, ISO B5, Envelope #10, Envelope #9, Envelope #6, Envelope Monarch, Envelope DL, Envelope C5, Hagaki, Oufukuhagaki, Youkei 4, Youkei 2, Custom	Select from special standard sizes and custom sizes.

### Relationship between Original Size, Sending Size, and Zoom

[Original Size \(page 6-8\)](#), Sending Size, and [Zoom \(page 6-14\)](#) are related to each other. For details, see the table below.

Original size and sending size are	the same	different
<a href="#">Original Size (page 6-8)</a>	Specify as necessary.	Specify as necessary.
<b>Sending Size</b>	Select [Same as Original Size].	Select the desired size.
<a href="#">Zoom (page 6-14)</a>	Select [100%] (or [Auto]).	Select [Auto].



#### NOTE

When you specify the sending size that is different from the original size, and select the zoom of [100%], you can send the image as the actual size (No Zoom).

## File Format



Specify the image file format. Image quality level can also be adjusted.

Select the file format from [PDF], [TIFF], [JPEG], [XPS], and [High Comp. PDF].

When the color mode in scanning has been selected for Grayscale or Full Color, set the image quality.

If you selected [PDF] or [High Comp. PDF], you can specify encryption or PDF/A settings.

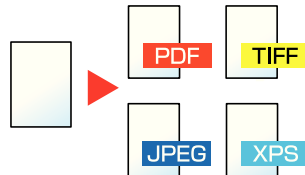

Item		Value	Description
<b>PDF</b>		—	Set the file format selected.
<b>High Comp. PDF</b>		—	The image quality and PDF/A settings will be the default settings. For the default settings, refer to <a href="#">Function Defaults on page 8-15</a> .
<b>TIFF</b>		—	
<b>JPEG</b>		—	
<b>XPS</b>		—	
<b>Others</b>	<b>File Format</b>	PDF, High Comp. PDF, TIFF, JPEG, XPS	
	<b>Image Quality</b> <sup>*1</sup>	Compression Ratio Priority, Standard, Quality Priority	Set the quality level for High Compression PDF.
	<b>Image Quality</b> <sup>*2</sup>	1 Low (High Comp.) to 5 High (Low Comp.)	Set the image quality.
	<b>PDF/A</b> <sup>*3</sup>	Off, PDF/A-1a, PDF/A-1b	Set PDF/A-1 format type.
	<b>Encryption</b> <sup>*3</sup>	—	You can use PDF encryption functions. For details, refer to <a href="#">PDF Encryption Functions on page 6-25</a> .

\*1 Displayed when [High Comp. PDF] is selected for "File Format".

\*2 Displayed when something other than [High Comp. PDF] is selected for "File Format".

\*3 Displayed when [PDF] or [High Comp. PDF] is selected for "File Format".



### NOTE

If encryption is enabled, PDF/A settings cannot be specified.

## PDF Encryption Functions

If you have selected PDF or High Comp. PDF for file format, you can restrict the access level for displaying, printing, and editing PDF's by assigning a secure password.

Select [Others], [PDF] or [HighComp.PDF] in [File Format], and press [Encryption].

Items that can be set vary depending on the setting selected in "Compatibility".

### When [Acrobat 3.0 and later, Encryption Level: Middle(40-bit)] is selected

Item	Value	Description
<b>Password to Open Document</b>	Off, On	Enter the password to open the PDF file. Press [On], enter a password (up to 256 characters) and then press [Next]. Enter the password again for confirmation, and press [OK].
<b>Password to Edit/Print Document</b>	Off, On	Enter the password to edit the PDF file. Press [On], enter a password (up to 256 characters) and then press [Next]. Enter the password again for confirmation, and press [OK]. When you have entered the password to edit/print document, you can specifically limit the operation.
<b>Printing Allowed</b>	Not Allowed, Allowed	Restricts printing of the PDF file.
<b>Changes Allowed</b>	Not Allowed	Disables the change to the PDF file.
	Commenting	Can only add commenting.
	Page Layout except extracting Pages	Can change the page layout except extracting the pages of the PDF file.
	Any except extracting Pages	Can conduct all operations except extracting the pages of the PDF file.
<b>Copying of Text/Images/Others</b>	Disable, Enable	Restricts the copying of text and objects on the PDF file.

**When [Acrobat 5.0 and later, Encryption Level: High(128-bit)] is selected**

Item	Value	Description
<b>Password to Open Document</b>	Off, On	Enter the password to open the PDF file. Press [On], enter a password (up to 256 characters) and then press [Next]. Enter the password again for confirmation, and press [OK].
<b>Password to Edit/Print Document</b>	Off, On	Enter the password to edit the PDF file. Press [On], enter a password (up to 256 characters) and then press [Next]. Enter the password again for confirmation, and press [OK]. When you have entered the password to edit/print document, you can specifically limit the operation.
<b>Printing Allowed</b>	Not Allowed	Disables the printing of PDF file.
	Allowed (Low Resolution only)	Can print the PDF file only in low resolution.
	Allowed	Can print the PDF file in original resolution.
<b>Changes Allowed</b>	Not Allowed	Disables the change to the PDF file.
	Inserting/Deleting/Rotating Pages	Can only insert, delete, and rotate the pages of the PDF file.
	Commenting	Can only add commenting.
	Any except extracting Pages	Can conduct all operations except extracting the pages of the PDF file.
<b>Copying of Text/Images/Others</b>	Disable, Enable	Restricts the copying of text and objects on the PDF file.

## File Separation



Creates several files by dividing scanned original data page by page, and sends the files.

(Value: [Off] / [Each Page])

Press [Each Page] to set File Separation.

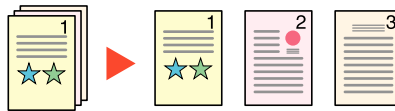

### NOTE

A three-digit serial number such as "abc\_001.pdf, abc\_002.pdf..." is attached to the end of the file name.

## Scan Resolution



Select fineness of scanning resolution.

The selectable resolution is [600 × 600dpi], [400 × 400dpi Ultra], [300 × 300dpi], [200 × 400dpi Super], [200 × 200dpi Fine], or [200 × 100dpi Normal].

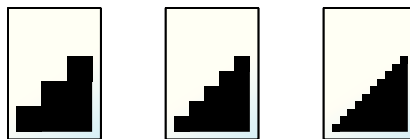

### NOTE

The larger the number, the better the image resolution. However, better resolution also means larger file sizes and longer send times.

## E-mail Subject/Body



Adds subject and body when sending a document.

Press [Subject] / [Body] to enter the E-mail subject/body.

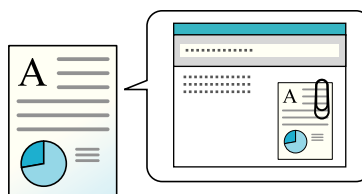

### NOTE

The subject can include up to 60 characters, and the body can include up to 500 characters.

## FTP Encrypted TX



Encrypts images when sending via FTP. Encryption secures the document transmission.

(Value: [Off] / [On])

### NOTE

You can only change the settings by logging in with administrator privileges.

The factory default login user name and login password are set as shown below.

Model Name	Login User Name	Login Password
ECOSYS M3040idn/ECOSYS M3540idn	4000	4000
ECOSYS M3550idn	5000	5000
ECOSYS M3560idn	6000	6000

Click [[Security Settings](#)], and then [[Network Security](#)] in the Command Center RX. Be sure that "SSL" of Secure Protocol Settings is "On" and one or more effective encryption are selected in Client side settings.

For details, refer to the [Command Center RX User Guide](#).

## Delete after Printed



Automatically deletes a document from the box once printing is complete.

(Value: [Off] / [On])



## Storing Size



Select size of image to be stored.

Press [Same as Original Size], [Metric], [Inch], or [Others] to select the sending size.

Item	Value	Description
Same as Original Size	—	Store an image the same size as the original.
Metric	A4, A5, A6, B5, B6, Folio, 216 × 340 mm	Select from the Metric standard sizes.
Inch	Letter, Legal, Statement, Executive, Oficio II	Select from the Inch series standard sizes.
Others	16K, ISO B5, Envelope #10, Envelope #9, Envelope #6, Envelope Monarch, Envelope DL, Envelope C5, Hagaki, Oufukuhagaki, Youkei 4, Youkei 2	Select from special standard sizes and custom sizes.

### Relationship between Original Size, Storing Size, and Zoom

[Original Size \(page 6-8\)](#), Storing Size, and [Zoom \(page 6-14\)](#) are related to each other. For details, see the table below.

Original Size and the size you wish to store as are	the same	different
<a href="#">Original Size (page 6-8)</a>	Specify as necessary.	Specify as necessary.
Storing Size	Select [Same as Original Size].	Select the desired size.
<a href="#">Zoom (page 6-14)</a>	Select [100%] (or [Auto]).	Select [Auto].



#### NOTE

When you select Storing Size that is different from Original Size, and select the Zoom [100%], you can store the image as the actual size (No Zoom).

## Encrypted PDF Password



Enter the preassigned password to print the PDF data.

Press [Password] to enter the Password, and press [OK].



#### NOTE

For details on entering the password, refer to [Character Entry Method on page 11-12](#).

## JPEG/TIFF Print



Select the image size when printing JPEG or TIFF files.

Select [Paper Size], [Image Resolution] or [Print Resolution].

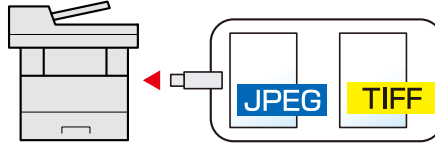

Item	Description
<b>Paper Size</b>	Fits the image size to the selected paper size.
<b>Image Resolution</b>	Prints at resolution of the actual image.
<b>Print Resolution</b>	Fits the image size to the print resolution.

## XPS Fit to Page



Reduces or enlarges the image size to fit to the selected paper size when printing XPS file.

(**Value:** [Off] / [On])

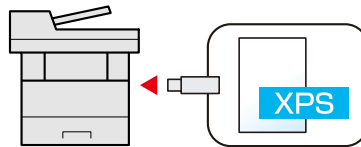

# 7 Status/Job Cancel

This chapter explains the following topics:

Checking Job Status .....	7-2
Details of the Status Screens .....	7-4
Checking Detailed Information of Jobs .....	7-8
Checking Job History .....	7-9
Checking the Detailed Information of Histories .....	7-11
Sending the Log History .....	7-11
Job Operation .....	7-12
Pause and Resumption of Jobs .....	7-12
Canceling of Jobs .....	7-12
Device/Communication .....	7-13
Checking the Remaining Amount of Toner and Paper (Paper/Supplies) .....	7-15

# Checking Job Status

Check the status of jobs being processed or waiting to be printed.

## Available Status Screens

The processing and waiting statuses of jobs are displayed as a list on the touch panel in four different screens - Printing Jobs, Sending Jobs, Storing Jobs, and Scheduled Jobs.

The following job statuses are available.

Status Display	Job status to be displayed
Print Job Status	<ul style="list-style-type: none"> <li>• Copy</li> <li>• Printer</li> <li>• FAX reception</li> <li>• E-mail reception</li> <li>• Printing from Document Box</li> <li>• Printing data from removable memory</li> <li>• Application</li> <li>• Job Report/List</li> </ul>
Send Job Status	<ul style="list-style-type: none"> <li>• FAX transmission</li> <li>• E-mail</li> <li>• Folder transmission</li> <li>• Application</li> <li>• Multiple destination</li> </ul>
Store Job Status	<ul style="list-style-type: none"> <li>• Scan</li> <li>• FAX</li> <li>• Printer</li> </ul>
Scheduled Job	<ul style="list-style-type: none"> <li>• Sending Job FAX using Delayed transmission</li> </ul>

## Displaying Status Screens

### 1 Display the screen.

Press the [**Status/Job Cancel**] key.

Status/  
Job Cancel



### 2 Select the job you want to check.

Press either of [Print Job Status], [Send Job Status], [Store Job Status] or [Scheduled Job] to check the status.

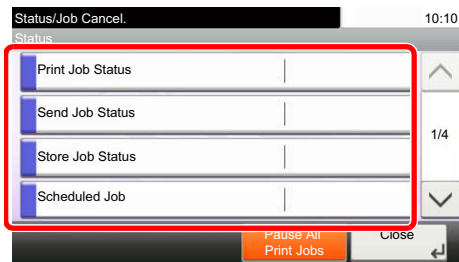

-  [Print Job Status Screen \(page 7-4\)](#)
- [Send Job Status Screen \(page 7-5\)](#)
- [Store Job Status Screen \(page 7-6\)](#)
- [Scheduled Job Status Screen \(page 7-7\)](#)







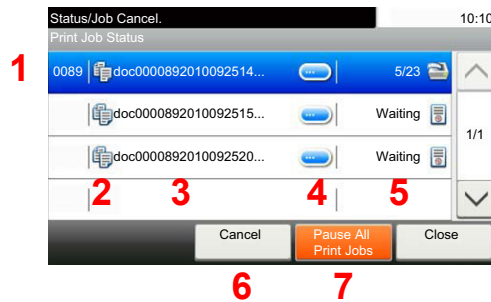

## Details of the Status Screens

 **NOTE**

You can show the job statuses of all users, or only the statuses of your own jobs. For details, refer to [Display Status/Log on page 8-19](#). This setting can also be changed from Command Center RX. For details, refer to the **Command Center RX User Guide**.







### Print Job Status Screen

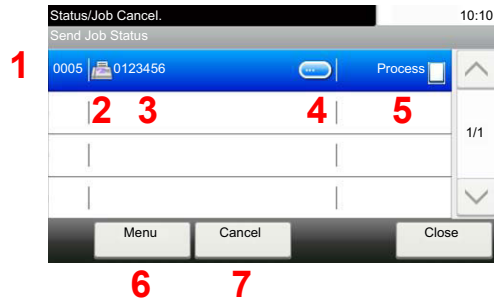

No.	Item	Description
1	Job No.	Acceptance No. of job
2	Type	Icons that indicate the job type  Copy job  Printer job  Job from Document Box  FAX reception  E-mail reception  Data from removable memory  Application  Report/List
3	Job Name	Job Name or file name
4	[  ]	Press this key for the job for which you wish to display detailed information. (Refer to <a href="#">Checking Detailed Information of Jobs on page 7-8</a> .)
5	Status	Status of job (Number of copies printed)/(Total number of copies to be printed): Printing Processing: The status before starting to print. Waiting: Print Waiting Pause: Pausing print job or error Canceling: Canceling the job
6	[Cancel]	Select the job you want to cancel from the list, and press this key.
7	[Pause All Print Jobs]	Pauses all the printing jobs. By pressing this key again, the printing jobs will be resumed.





## Send Job Status Screen

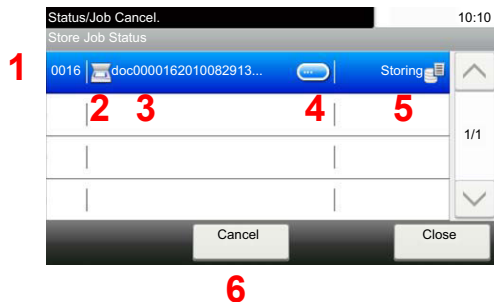

No.	Item	Description
1	Job No.	Acceptance No. of job
2	Type	Icons that indicate the job type  Sending Job FAX  Sending Job E-mail  Sending Job Folder  Sending Job Application  Multi Sending
3	User Name	User Name for the executed job
4	[  ]	Press this key for the job for which you wish to display detailed information. (Refer to <a href="#">Checking Detailed Information of Jobs on page 7-8.</a> )
5	Status	Status of job Processing: The status before starting sending such as during scanning originals Sending: Sending Waiting: Waiting Sending Canceling: Canceling the job Pause: Pausing the job
6	[Menu]	Pressing this key displays [Priority Override]. This function allows you to give a particular fax job priority. Select the fax job you wish to send immediately and then press [Menu], followed by [Priority Override].
7	[Cancel]	Select the job you want to cancel from the list, and press this key.

### Store Job Status Screen





No.	Item	Description
1	Job No.	Acceptance No. of job
2	Type	Icons that indicate the job type  Storing Job Scan  Storing Job Printer  Storing Job FAX
3	Job Name	Job name or file name is displayed.
4	[  ]	Press this key for the job for which you wish to display detailed information. (Refer to <a href="#">Checking Detailed Information of Jobs on page 7-8.</a> )
5	Status	Status of job Processing: The status before starting to save such as during scanning originals Storing: Storing Data Canceling: Canceling the job Pause: Pausing the job
6	[Cancel]	Select the job you want to cancel from the list, and press this key.

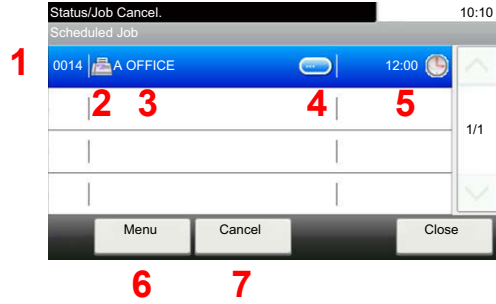

## Scheduled Job Status Screen



No.	Item	Description
1	Job No.	Acceptance No. of job
2	Type	Icons that indicate the job type  Storing Job FAX
3	Destination	Destination (Either destination name, FAX number, or No. of broadcast items)
4	[  ]	Press this key for the job for which you wish to display detailed information. (Refer to <a href="#">Checking Detailed Information of Jobs on page 7-8.</a> )
5	Start Time	Time to start the scheduled job
6	[Menu]	Pressing this key displays [Start Now]. Select the job you wish to send immediately and then press [Menu], followed by [Start Now].
7	[Cancel]	Select the job you want to cancel from the list, and press this key.

## Checking Detailed Information of Jobs

Check the detailed information of each job.

### NOTE

When you have logged in as a user, you can only check your own jobs. When you have logged in as administrator, you can check all jobs.

### 1 Display the screen.

Referring to [Details of the Status Screens on page 7-4](#), display the screen.

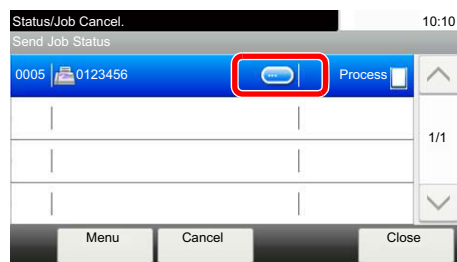

### 2 Check the information.

1 Press [] for the job for which you wish to display detailed information.

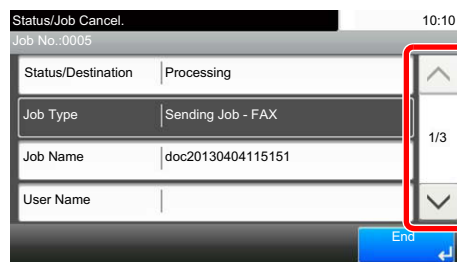

Detailed information of the selected job is displayed.



Use [] or [] to see the next or previous page of information. More detailed information can be checked if a white item is selected.

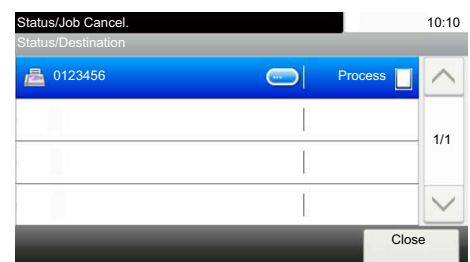
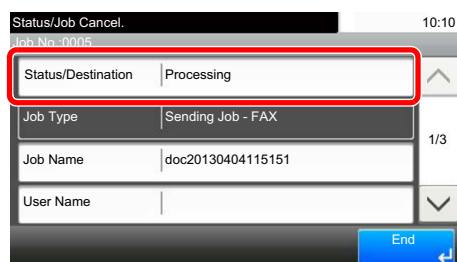

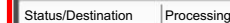
In Sending Jobs, you can check the destination by pressing [].

2 To exit from the detailed information, press [].

# Checking Job History

Check the history of completed jobs.



## NOTE

- Job history is also available by Command Center RX or KYOCERA Net Viewer from the computer.
- You can show the job log of all users, or only your own job log. For details, refer to [Display Status/Log on page 8-19](#). This setting can also be changed from Command Center RX. For details, refer to the **Command Center RX User Guide**.

## Available Job History Screens

The job histories are displayed separately in three screens - Printing Jobs, Sending Jobs, and Storing Jobs. The following job histories are available.

Screen	Job histories to be displayed
Print Job Log	<ul style="list-style-type: none"> <li>• Copy</li> <li>• Printer</li> <li>• FAX reception</li> <li>• E-mail reception</li> <li>• Printing from Document Box</li> <li>• Application</li> <li>• Job Report/List</li> <li>• Printing data from removable memory</li> </ul>
Send Job Log	<ul style="list-style-type: none"> <li>• FAX</li> <li>• E-mail</li> <li>• Folder</li> <li>• Application</li> <li>• Multiple destination</li> </ul>
Store Job Log	<ul style="list-style-type: none"> <li>• Scan</li> <li>• FAX</li> <li>• Printer</li> </ul>

## Displaying Job History Screen

### 1 Display the screen.

Press the [**Status/Job Cancel**] key.

Status/  
Job Cancel



### 2 Select the job you want to check.

Press either of [Print Job Log], [Send Job Log], or [Store Job Log] to check the log.



#### NOTE

If the user authentication screen appears, enter your login user name and login password and press [Login]. For this, you need to login with administrator privileges. The factory default login user name and login password are set as shown below.

Model Name	Login User Name	Login Password
ECOSYS M3040idn/ ECOSYS M3540idn	4000	4000
ECOSYS M3550idn	5000	5000
ECOSYS M3560idn	6000	6000

## Checking the Detailed Information of Histories

Check the detailed information of each history.

### 1 Display the screen.

Referring to [Displaying Job History Screen on page 7-10](#), display the screen.

### 2 Check the information.

1 Press [>] for the job for which you wish to check details.

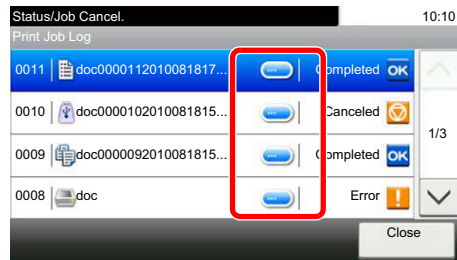

Detailed information of the selected job is displayed.

#### NOTE

To check the information of the next/previous page, press [>] or [>].

2 To exit from the detailed information, press [Close].

## Sending the Log History

You can send the log history by E-mail. You can either send it manually as needed or have it sent automatically whenever a set number of jobs is reached. For details, refer to [Sending Log History on page 8-8](#).

# Job Operation

## Pause and Resumption of Jobs

Pause/resume all printing jobs in printing/waiting.

### 1 Display the screen.

Press the [Status/Job Cancel] key.

Status/  
Job Cancel



### 2 Press [Pause All Print Jobs] on the printing jobs status screen.

Printing is paused.

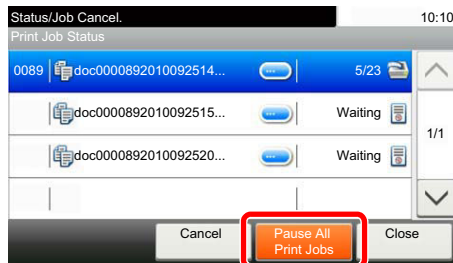

When resuming the printing of jobs that have been paused, press [Resume All Print Jobs].

## Canceling of Jobs

A job in printing/waiting status can be canceled.

### 1 Display the screen.

Press the [Status/Job Cancel] key.

Status/  
Job Cancel



### 2 Select the job to be canceled from the list, and press [Cancel].

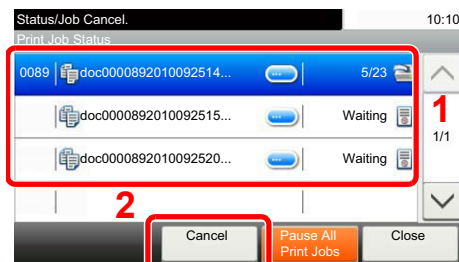

### 3 Press [Yes] in the confirmation screen.

# Device/Communication

Configure the devices/lines installed or connected to this machine or check their status.

## 1 Display the screen.

- 1 Press the [Status/Job Cancel] key.



- 2 Select the device you wish to check.

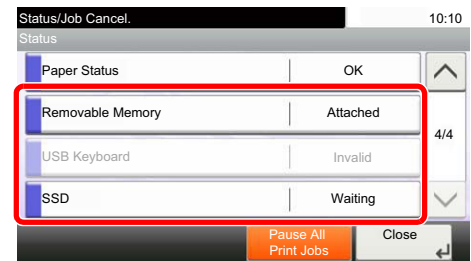
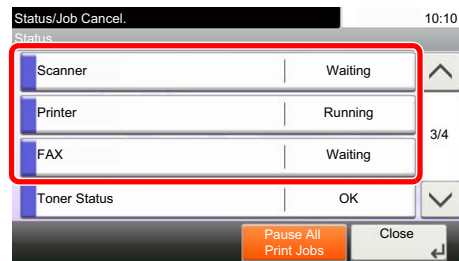

The screen to check the status or configure the devices is displayed.

## 2 Check the status.

The items you can check are described below.

### "Scanner"

The status of an original scanning or the error information (paper jam, opened cover, etc.) is displayed.

### "Printer"

Error information such as paper jam, out of toner, or out of paper, and status such as waiting or printing are displayed.

### "FAX"

- The information such as sending/receiving and dialing is displayed.
- Press [Line Off] to cancel a fax in sending/receiving.

For details, refer to the **FAX Operation Guide**.

### "Removable Memory (USB Memory)"

- The usage and capacity of the external media connected to this machine are displayed.
- Press [Menu] and then [Format] to format external media.



#### IMPORTANT

When [Format] is pressed, all data in the external media is erased.

- Press [Remove] to safely remove the external media.

### "USB Keyboard"

The status of the optional USB Keyboard is displayed.

**"SSD"**

The status of the optional SSD is displayed.

**"Connection Status"**

The connection status of the optional Wireless Network Interface Kit is displayed.



# Checking the Remaining Amount of Toner and Paper (Paper/Supplies)

Check the remaining amount of toner, paper, and staples on the touch panel.

## 1 Display the screen.

## 2 Display the screen.

- 1 Press the [Status/Job Cancel] key.



- 2 Press [∨], and then [Toner Status] or [Paper Status].

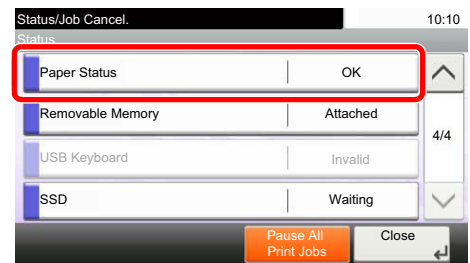
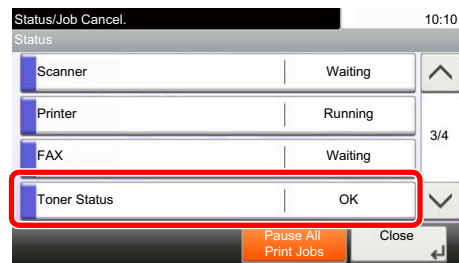

## 3 Check the status.

The items you can check are described below.

### "Toner Status"

- Black  
You can check the remaining amount of toner level from 100 to 0% (1% increments).
- Waste Toner  
You can check the status of waste toner box.

### "Paper Status"

You can check the size, orientation, type, and remaining amount of paper in each paper source. The remaining amount of paper is shown by 4 levels as 100, 70, 30, and 0%, however, the paper in the multi purpose tray is shown by 2 levels as 100% and 0%.

If the remaining amount of paper cannot be detected, "----" appears.

# 8 Setup and Registration (System Menu)

This chapter explains the following topics:

System Menu .....	8-2
Operation Method .....	8-2
System Menu Settings .....	8-4
Language .....	8-6
Report .....	8-6
User Property .....	8-9
Cassette/MP Tray Settings .....	8-9
Common Settings .....	8-11
Home .....	8-19
Copy .....	8-20
Send .....	8-21
Document Box .....	8-22
FAX .....	8-22
Application .....	8-23
Internet .....	8-23
Address Book/One Touch .....	8-23
User Login/Job Accounting .....	8-24
Printer .....	8-25
System/Network .....	8-27
Date/Timer/Energy Saver .....	8-37
Adjustment/Maintenance .....	8-40

# System Menu

Configure settings related to overall machine operation.

## Operation Method

System Menu is operated as follows:

### 1 Display the screen.

Press the [System Menu] key.

System Menu /  
Counter



### 2 Select a function.

Displays the System  
Menu items.

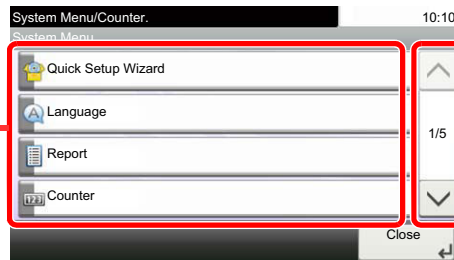

Scrolls up and down  
when the list of values  
cannot be displayed in  
its entirety on a single  
screen.



Displays setting items  
Press the key of a  
function to display  
the setting screen.



Returns to the previous  
screen.

### 3 Configure the settings.

Selecting a value it to  
be accepted.

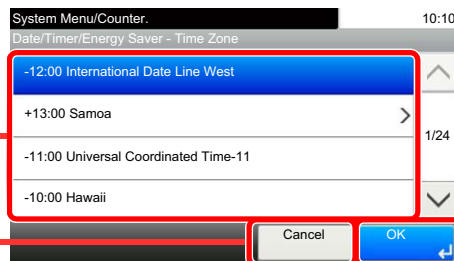

Returns to the original  
screen without making  
any changes.

Accepts the settings and  
exits.



**NOTE**

- In order to change settings that require administrator privileges, you must log in with administrator privileges.

The factory default login user name and login password are set as shown below.

Model Name	Login User Name	Login Password
ECOSYS M3040idn/ ECOSYS M3540idn	4000	4000
ECOSYS M3550idn	5000	5000
ECOSYS M3560idn	6000	6000

- If function default settings have been changed, the **[Reset]** key can be pressed in each function screen to immediately change the settings.

Refer to [System Menu Settings](#) on the following page and configure as needed.

## System Menu Settings

This section explains the functions that can be configured in System Menu. To configure the settings, select the item in System Menu and press the setting item. For details on each function, see the table below.

Item	Description	Reference Page
<b>Quick Setup Wizard</b>	The Quick Setup Wizard configures Fax, Network and Energy Saver settings.	<a href="#">page 2-17</a>
<b>Language</b>	Select the language displayed on the touch panel.	<a href="#">page 8-6</a>
<b>Report</b>	Print reports to check the machine settings and status. Default settings for printing the result reports can also be configured.	<a href="#">page 8-6</a>
<b>Print Report</b>	Configure settings for printing reports and histories.	<a href="#">page 8-6</a>
<b>Admin Report Settings</b>		Refer to the <b>FAX Operation Guide</b> .
<b>Result Report Setting</b>		<a href="#">page 8-8</a>
<b>Sending Log History</b>		<a href="#">page 8-8</a>
<b>Counter</b>	This counts the number of pages printed or scanned.	<a href="#">page 2-31</a>
<b>User Property</b>	Allows you to view information about logged in users and edit some of that information.	<a href="#">page 8-9</a>
<b>Cassette/MP Tray Settings</b>	Select paper size and media type for Cassette 1 to 3 and multi purpose tray.	<a href="#">page 8-9</a>
<b>Cassette 1 (to 5)</b>	Select type of paper in Cassette 1 (to 5).	<a href="#">page 8-9</a>
<b>Multi Purpose Tray</b>	Select type of paper in multi purpose tray.	<a href="#">page 8-10</a>
<b>Common Settings</b>	Configures overall machine operation.	<a href="#">page 8-11</a>
<b>Default Screen</b>	Select the screen appearing right after start-up (default screen).	<a href="#">page 8-11</a>
<b>Sound</b>	Set options for buzzer sound during the machine operations.	<a href="#">page 8-11</a>
<b>Original Settings</b>	Configures settings for originals.	<a href="#">page 8-12</a>
<b>Paper Settings</b>	Configures settings for paper.	<a href="#">page 8-13</a>
<b>Function Defaults</b>	Defaults are the values automatically set after the warm-up is completed or the <b>[Reset]</b> key is pressed. Set the defaults for available settings such as copying and sending. Setting the frequently-used values as defaults makes subsequent jobs easier.	<a href="#">page 8-15</a>
<b>Preset Limit</b>	Restrict the number of copies that can be made at one time.	<a href="#">page 8-17</a>
<b>Error Handling</b>	Select whether to cancel or continue the job when error has occurred.	<a href="#">page 8-17</a>
<b>Measurement</b>	Select inch or metric for the unit for paper dimensions.	<a href="#">page 8-17</a>
<b>Low Toner Alert Level</b>	Set the amount of remaining toner to notify the administrator when to order a toner when the toner is running low.	<a href="#">page 8-18</a>
<b>Keyboard Layout</b>	Change the layout of the touch panel keyboard used to enter characters.	<a href="#">page 8-18</a>
<b>USB Keyboard Type</b>	Select the type of USB keyboard that you want to use.	<a href="#">page 8-18</a>
<b>Format SSD</b>	Format an optional SSD.	<a href="#">page 8-18</a>
<b>Format SD Card</b>	Format an optional SD/SDHC memory card.	<a href="#">page 8-19</a>
<b>Display Status/Log</b>	Set the display method of the Status/Log.	<a href="#">page 8-19</a>
<b>Function Key Usage</b>	Configure settings for function key on the operation panel.	<a href="#">page 8-19</a>

Item	Description	Reference Page
<b>Home</b>	Configure settings for Home screen.	<a href="#">page 8-19</a>
<b>Copy</b>	Configures settings for copying functions.	<a href="#">page 8-20</a>
<b>Send</b>	Configures settings for sending functions.	<a href="#">page 8-21</a>
<b>Document Box</b>	Configures settings related to the Job Box, Sub Address Box and Polling Box. For details on Job Box, refer to <a href="#">Printing Data Saved on the Printer on page 4-8</a> and for details on Sub Address Box and Polling Box, refer to the <b>FAX Operation Guide</b> .	—
<b>FAX</b>	Configures settings for fax functions. Refer to the <b>FAX Operation Guide</b> .	—
<b>Application</b>	Configure settings for Application.	<a href="#">page 8-23</a>
<b>Internet</b>	Set the proxy for connection to the Internet from an application.	<a href="#">page 8-23</a>
<b>Address Book/One Touch</b>	Configures Address Book and One Touch Key settings. For details on Address Book, refer to <a href="#">Adding a Destination (Address Book) on page 3-35</a> and for details on One Touch Key, refer to <a href="#">Adding a Destination on One Touch Key (One Touch Key) on page 3-41</a> .	—
<b>User Login/Job Accounting</b>	Configures settings related to machine management. For details on User Login, refer to <a href="#">Overview of User Login Administration on page 9-2</a> , and for details on Job Accounting, refer to <a href="#">Overview of Job Accounting on page 9-32</a> .	—
<b>Printer</b>	Printing from computers, settings are generally made on the application software screen. However, the following settings are available for configuring the defaults to customize the machine.	<a href="#">page 8-25</a>
<b>System/Network</b>	Configures machine system settings.	<a href="#">page 8-27</a>
<b>Network</b>	Configures network settings.	<a href="#">page 8-27</a>
<b>Optional Network</b>	Configure settings for the optional Network Interface Kit or Wireless Network Interface Kit.	<a href="#">page 8-32</a>
<b>Network Interface (Send)</b>	Specify the network interface card to be used for the send function, the network authentication and connecting to external address book.	<a href="#">page 8-34</a>
<b>Interface Block Setting</b>	This allows you to protect this machine by blocking the interface with external devices such as USB hosts or optional interfaces.	<a href="#">page 8-34</a>
<b>Security Level</b>	The Security Level setting is primarily a menu option used by service personnel for maintenance work. There is no need for customers to use this menu.	—
<b>Restart</b>	Restart the CPU without turning the main power switch off. Use this to deal with any unstable operation by the machine. (Same as the computer restart.)	—
<b>RAM Disk Setting</b>	A RAM disk can be created and its size can be set. Creating a RAM disk makes it possible to print from a Job Box.	<a href="#">page 8-35</a>
<b>Optional Memory</b>	When optional memory is installed, select the memory allocation scheme based on the application in which you are using the equipment.	<a href="#">page 8-36</a>
<b>Data Security</b>	Configure settings for data stored in the SSD.	<a href="#">page 8-36</a>
<b>Optional Function</b>	You can use the optional applications installed on this machine.	<a href="#">page 11-10</a>
<b>Date/Timer/Energy Saver</b>	Configures settings related to the date and time.	<a href="#">page 8-37</a>
<b>Adjustment/Maintenance</b>	Adjust printing quality and conduct machine maintenance.	<a href="#">page 8-40</a>

# Language

System Menu / Counter



▶ Language

Item	Description
Language	Select the language displayed on the touch panel.

# Report

Print reports to check the machine settings and status. Default settings for printing the result reports can also be configured.



## Report Print

System Menu / Counter



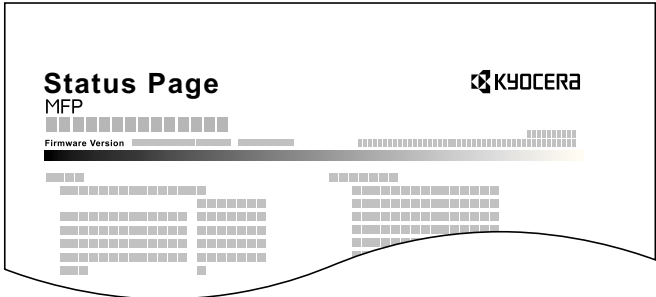
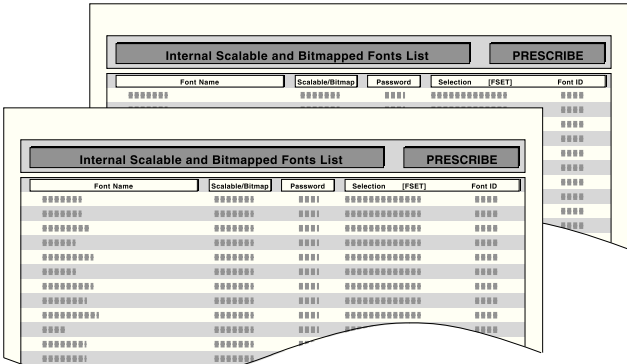

▶ Report ▶ Report Print

Item	Description
Status Page	<p>Prints the status page, allowing you to check the information including current settings, available memory space, and optional equipment installed.</p> 
Font List	<p>Prints the font list, allowing you to check the font samples installed in the machine.</p> 

Item	Description
<p><b>Network Status</b></p>	<p>Prints the network status, allowing you to check the information including network interface firmware version, network address and protocol.</p> <div data-bbox="657 286 1315 577" style="border: 1px solid black; padding: 10px; margin: 10px auto; width: fit-content;"> </div>
<p><b>Service Status</b></p>	<p>Prints the service status. More detailed information is available than on the Status Page. Service personnel usually print the service status pages for maintenance purpose.</p>
<p><b>Accounting Report</b></p>	<p>Prints the accounting report, allowing you to check the accounts that have been registered on the machine.</p>
<p><b>Sub Address Box List</b></p>	<p>Prints the report on the FAX function. For details, refer to the <b>FAX Operation Guide</b>.</p>
<p><b>FAX List (Index)</b></p>	<p> <b>NOTE</b></p>
<p><b>FAX List (No.)</b></p>	<p>FAX functions are available only on products with the fax function installed.</p>
<p><b>Outgoing FAX Report</b></p>	
<p><b>Incoming FAX Report</b></p>	
<p><b>Optional Network Status</b></p>	<p>Prints the optional network status, allowing you to check the information including optional network interface firmware version, network address and protocol.</p> <p> <b>NOTE</b></p> <p>This function is displayed when the optional Network Interface Kit or Wireless Network Interface Kit is installed.</p>

## Admin Report Settings

System Menu / Counter

 **Report**  **Admin Report Settings**

Configure settings for fax functions. For details, refer to the **FAX Operation Guide**.



## Result Report Settings

System Menu / Counter



▶ Report ▶ Result Report Settings

Item	Description
<b>Send Result Report</b>	Automatically print a report of transmission result when a transmission is complete.
<b>E-mail/Folder</b>	Automatically print a report of transmission result when E-mail or SMB/FTP transmission is complete. <b>Value: Off, On, Error Only</b>
<b>FAX<sup>*1</sup></b>	For details, refer to the <b>FAX Operation Guide</b> .
<b>Canceled before Sending<sup>*2</sup></b>	Print a send result report if the job is canceled before being sent. <b>Value: Off, On</b>
<b>Recipient Format<sup>*2</sup></b>	Select the Recipient Format for the send result report. <b>Value: Name or Destination, Name and Destination</b>
<b>RX Result Report<sup>*1</sup></b>	For details, refer to the <b>FAX Operation Guide</b> .
<b>Job Finish Notice Setting</b>	Attaches sent images to job finish notices. <b>Value: Do Not Attach Image, Attach Image</b>

\*1 Only on products with the fax function installed.

\*2 When "E-mail/Folder" and "FAX" are set to [Off], this function will not be displayed.

## Sending Log History

System Menu / Counter



▶ Report ▶ Sending Log History

Item	Description
<b>Sending Log History</b>	You can also send the log history to the specified destinations manually. Set the destinations at "Destination" in advance.
<b>Auto Sending</b>	This function automatically sends the log history to the specified destinations whenever a set number of jobs has been logged. <b>Value: Off, On</b>  <b>NOTE</b> If [On] is selected, specify the number of job histories. The setting range is 1 to 16.
<b>Destination</b>	Set the destination to which log histories are sent. Only E-mail address can be set.
<b>Job Log Subject</b>	Set the subject automatically entered when sending log histories by E-mail. <b>Value: Up to 60 characters</b>
<b>Personal Information</b>	Select whether to include personal information in the job log. <b>Value: Include, Exclude</b>

## User Property

System Menu / Counter



### User Property

Allows you to view information about logged in users and edit some of that information.



[Changing User Properties \(page 9-9\)](#)

## Cassette/MP Tray Settings

Select paper size and media type for Cassettes and multi purpose tray.

### Cassette 1 (to 5)

System Menu / Counter



### Cassette/MP Tray Settings ▶ Cassette1 (to 5)

Select paper size and media type for Cassettes 1 to 5.

Selection Item		Selectable Size/Type
Paper Size <sup>*1</sup>	Metric	Select from the Metric standard sizes. <b>Values</b> Cassette 1: A4, A5, A6, B5, B6, Folio, 216 × 340 mm Cassettes 2 to 5: A4, A5, B6, B5, Folio, 216 × 340 mm
	Inch	Select from the Inch series standard sizes. <b>Values:</b> Letter, Legal, Statement, Executive, Oficio II
	Other	Select from special standard sizes and custom sizes. <b>Values</b> Cassette 1: 16K, ISO B5, Envelope DL <sup>*2</sup> , Envelope C5, Oufuku Hagaki <sup>*2</sup> , Custom <sup>*3</sup> Cassettes 2 to 5: 16K, ISO B5, Envelope #10, Envelope #9, Envelope #6, Envelope Monarch, Envelope DL, Envelope C5, Oufuku Hagaki, Youkei 4, Youkei 2, Custom <sup>*3</sup>
Media type <sup>*4</sup>		Select the media type. <b>Values</b> Cassette 1: Plain (60 - 105 g/m <sup>2</sup> ), Rough, Recycled, Preprinted <sup>*5</sup> , Bond, Color, Prepunched <sup>*5</sup> , Letterhead <sup>*5</sup> , High Quality, Custom 1 - 8 Cassettes 2 to 5: Plain (60 - 105 g/m <sup>2</sup> ), Rough, Recycled, Preprinted <sup>*5</sup> , Bond, Color, Prepunched <sup>*5</sup> , Letterhead <sup>*5</sup> , Envelope, High Quality, Custom 1 - 8

\*1 Only set this when the size dial on the cassette is set to "Other".

\*2 ECOSYS M3550idn/ECOSYS M3560idn only.

\*3 The custom paper sizes are set for each cassette. Refer to [Custom Paper Size on page 8-13](#).

\*4 To change to a media type other than Plain, refer to [Media Type Setting on page 8-14](#). When a paper weight that cannot be loaded in the cassette is set for a media type, that media type does not appear.

\*5 To print on preprinted or prepunched paper or on letterhead, refer to [Special Paper Action on page 8-14](#).

## Multi Purpose Tray

System Menu /  
Counter

▶ **Cassette/MP Tray Settings** ▶ **Multi Purpose Tray**

Item		Description
<b>Paper Size</b>	<b>Metric</b>	Select from the Metric standard sizes. <b>Values:</b> A4, A5, A6, B5, B6, Folio, 216 × 340 mm
	<b>Inch</b>	Select from the Inch series standard sizes. <b>Values:</b> Letter, Legal, Statement, Executive, Oficio II
	<b>Other</b>	Select from special standard sizes and custom sizes. <b>Values:</b> 16K, ISO B5, Envelope #10, Envelope #9, Envelope #6, Envelope Monarch, Envelope DL, Envelope C5, Hagaki, Oufuku hagaki, Youkei 4, Youkei 2, Custom <sup>*1</sup>
<b>Media Type<sup>*2</sup></b>		Select the media type. <b>Values:</b> Plain (60 to 105 g/m <sup>2</sup> ), Rough, Transparency, Vellum (60 to 63 g/m <sup>2</sup> ), Labels, Recycled, Preprinted <sup>*3</sup> , Bond, Cardstock, Color, Prepunched <sup>*3</sup> , Letterhead <sup>*3</sup> , Envelope, Thick (106 to 220 g/m <sup>2</sup> ), High Quality, Custom 1-8

\*1 For instructions on how to specify the custom paper size, refer to [Custom Paper Size on page 8-13](#).

\*2 To change to a media type other than "Plain", refer to [Media Type Setting on page 8-14](#).

\*3 To print on preprinted or prepunched paper or on letterhead, refer to [Special Paper Action on page 8-14](#).

## Common Settings

Configures overall machine operation.

### Default Screen

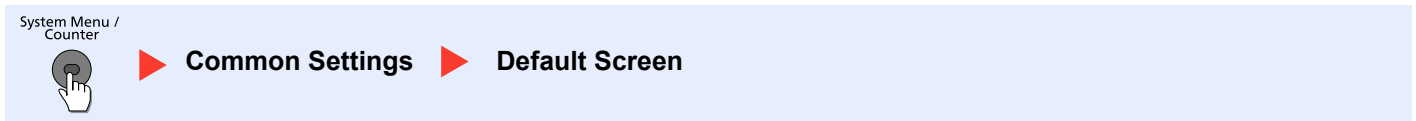

Item	Description
<b>Default Screen</b>	Select the screen appearing right after start-up (default screen). <b>Value:</b> Home, Copy, Send, FAX <sup>*1</sup> , Custom Box, Job Box, Removable Memory, Sub Address Box <sup>*1</sup> , Polling Box <sup>*1</sup> , Favorites, Status, Application Name <sup>*2</sup>

\*1 Only on products with the fax function installed.

\*2 The running application will be displayed. For details, refer to [Application on page 5-11](#).

### Sound

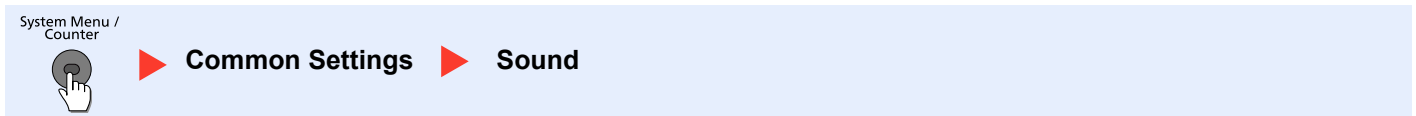

Item	Description
<b>Buzzer</b>	Set options for buzzer sound during the machine operations.
<b>Volume</b>	Set the buzzer volume level. <b>Value:</b> 0 (Mute), 1 (Minimum), 2, 3 (Medium), 4, 5 (Maximum)
<b>Key Confirmation</b>	Emit a sound when the operation panel and touch panel keys are pressed. <b>Value:</b> Off, On
<b>Job Finish</b>	Emit a sound when a print job is normally completed. <b>Value:</b> Off, On, FAX Reception Only <sup>*1</sup>
<b>Ready</b>	Emit a sound when the warm-up is completed. <b>Value:</b> Off, On
<b>Warning</b>	Emit a sound when errors occur. <b>Value:</b> Off, On
<b>USB Keyboard</b>	Emit a sound to confirm keypresses with a sound. <b>Value:</b> Off, On
<b>FAX Speaker Volume<sup>*1</sup></b>	For details, refer to the <b>FAX Operation Guide</b> .
<b>FAX Monitor Volume<sup>*1</sup></b>	For details, refer to the <b>FAX Operation Guide</b> .

\*1 Only on products with the fax function installed.

## Original Settings

System Menu /  
Counter



▶ Common Settings ▶ Original Settings

Item	Description
<p><b>Custom Original Size</b></p>	<p>Set up frequently-used custom original size. The custom size option is displayed on the screen to select original size.</p> <p><b>Value</b></p> <p><b>Metric</b> X: 50 to 356 mm (in 1 mm increments) Y: 50 to 216 mm (in 1 mm increments)</p> <p><b>Inch</b> X: 1.97 to 14.02" (in 0.01" increments) Y: 1.97 to 8.50" (in 0.01" increments)</p> <p>X=Length, Y=Width</p> <div data-bbox="868 757 1104 1003" style="text-align: center;"> <p>Horizontal</p> </div>
<p><b>Default Original Size</b></p>	<p>Set the default original size.</p> <p><b>Value</b></p> <p><b>Metric:</b> A4-R, A5-R, A6-R, B5-R, B6-R, Folio, 216 × 340 mm <b>Inch:</b> Letter-R, Legal, Statement-R, Executive, Oficio II <b>Others:</b> 16K-R</p>







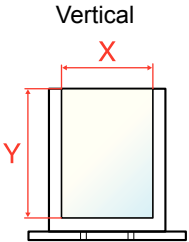
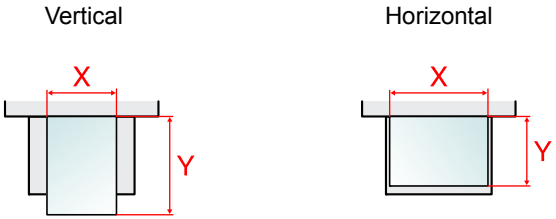

## Paper Settings

System Menu / Counter

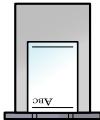
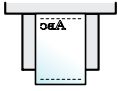

▶ Common Settings ▶ Paper Settings

Item	Description														
<b>Custom Paper Size</b>	<p>Set up frequently-used custom paper size.</p> <p>One custom paper size is set for each paper supply source. The custom size option is displayed on the screen to select paper size.</p>														
<b>Cassette 1 Size</b>	<p>Register the custom paper size to be used in Cassette 1.</p> <p><b>Value</b></p> <table border="0"> <tr> <td><b>ECOSYS M3040idn/ECOSYS M3540idn</b></td> <td><b>ECOSYS M3550idn/ECOSYS M3560idn</b></td> </tr> <tr> <td><b>Metric</b></td> <td><b>Metric</b></td> </tr> <tr> <td><b>X: 140 to 216 mm (in 1 mm increments)</b></td> <td><b>X: 105 to 216 mm (in 1 mm increments)</b></td> </tr> <tr> <td><b>Y: 210 to 356 mm (in 1 mm increments)</b></td> <td><b>Y: 148 to 356 mm (in 1 mm increments)</b></td> </tr> <tr> <td><b>Inch</b></td> <td><b>Inch</b></td> </tr> <tr> <td><b>X: 5.50 to 8.50" (in 0.01" increments)</b></td> <td><b>X: 4.13 to 8.50" (in 0.01" increments)</b></td> </tr> <tr> <td><b>Y: 8.25 to 14.02" (in 0.01" increments)</b></td> <td><b>Y: 5.83 to 14.02" (in 0.01" increments)</b></td> </tr> </table> <p><b>X=Length, Y=Width</b></p> 	<b>ECOSYS M3040idn/ECOSYS M3540idn</b>	<b>ECOSYS M3550idn/ECOSYS M3560idn</b>	<b>Metric</b>	<b>Metric</b>	<b>X: 140 to 216 mm (in 1 mm increments)</b>	<b>X: 105 to 216 mm (in 1 mm increments)</b>	<b>Y: 210 to 356 mm (in 1 mm increments)</b>	<b>Y: 148 to 356 mm (in 1 mm increments)</b>	<b>Inch</b>	<b>Inch</b>	<b>X: 5.50 to 8.50" (in 0.01" increments)</b>	<b>X: 4.13 to 8.50" (in 0.01" increments)</b>	<b>Y: 8.25 to 14.02" (in 0.01" increments)</b>	<b>Y: 5.83 to 14.02" (in 0.01" increments)</b>
<b>ECOSYS M3040idn/ECOSYS M3540idn</b>	<b>ECOSYS M3550idn/ECOSYS M3560idn</b>														
<b>Metric</b>	<b>Metric</b>														
<b>X: 140 to 216 mm (in 1 mm increments)</b>	<b>X: 105 to 216 mm (in 1 mm increments)</b>														
<b>Y: 210 to 356 mm (in 1 mm increments)</b>	<b>Y: 148 to 356 mm (in 1 mm increments)</b>														
<b>Inch</b>	<b>Inch</b>														
<b>X: 5.50 to 8.50" (in 0.01" increments)</b>	<b>X: 4.13 to 8.50" (in 0.01" increments)</b>														
<b>Y: 8.25 to 14.02" (in 0.01" increments)</b>	<b>Y: 5.83 to 14.02" (in 0.01" increments)</b>														
<b>Cassette 2 (to 5) Size</b>	<p>Register the custom paper size to be used in Cassettes 2 to 5.</p> <p><b>Value</b></p> <p><b>Metric</b></p> <p><b>X: 92 to 216 mm (in 1 mm increments)</b></p> <p><b>Y: 162 to 356 mm (in 1 mm increments)</b></p> <p><b>Inch</b></p> <p><b>X: 3.62 to 8.50" (in 0.01" increments)</b></p> <p><b>Y: 6.38 to 14.02" (in 0.01" increments)</b></p>														
<b>MP Tray Size</b>	<p>Register the custom paper size to be used in the multi purpose tray.</p> <p><b>Value</b></p> <p><b>Metric</b></p> <p><b>X: 70 to 216 mm (in 1 mm increments)</b></p> <p><b>Y: 148 to 356 mm (in 1 mm increments)</b></p> <p><b>Inch</b></p> <p><b>X: 2.76 to 8.50" (in 0.01" increments)</b></p> <p><b>Y: 5.83 to 14.02" (in 0.01" increments)</b></p> <p><b>X=Length, Y=Width</b></p> 														

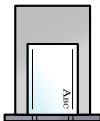
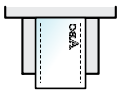
Item	Description
<b>Media Type Setting</b>	Select weight for each media type. For Custom 1-8, settings for duplex printing and media type name can be changed. For details, refer to <a href="#">Media Type Setting on page 8-14</a> .
<b>Default Paper Source</b>	Select the default paper source from Cassette 1-3 and multi purpose tray. <b>Value: Cassette 1 to 5, Multi Purpose Tray</b>  <b>NOTE</b> [Cassette 2] to [Cassette 5] are displayed when optional paper feeder is installed.
<b>Paper Selection</b>	Set the default paper selection. <b>Value</b> <b>Auto: Automatically select the cassette containing paper in the same size as originals.</b> <b>Default Paper Source: Select paper source set by <a href="#">Default Paper Source</a>.</b>
<b>Media for Auto (B&amp;W)</b>	Select a default media type for auto paper selection when [Auto] is selected of Paper Selection. If Plain is selected, the paper source with plain paper loaded in the specific size is selected. Select [All Media Types] for the paper source with any kind of paper loaded in the specific size. <b>Value: All Media Types, Plain, Transparency, Rough, Vellum, Labels, Recycled, Preprinted, Bond, Cardstock, Color, Prepunched, Letterhead, Envelope, Thick, High Quality, Custom 1 to 8</b>
<b>Special Paper Action</b>	When printing on Prepunched, Preprint, and Letterhead, punch-holes might not be aligned or the print direction might be upside-down depending on how originals are set and the combination of copying functions. In such a case, select [Adjust Print Direction] to adjust the print direction. When paper orientation is not important, select [Speed Priority]. Example: copying on Letterhead <div style="display: flex; justify-content: space-around; align-items: center;"> <div style="text-align: center;">  Original         </div> <div style="text-align: center;">  Paper         </div> <div style="text-align: center;">  Finished         </div> <div style="text-align: center;">  Cassette         </div> <div style="text-align: center;">  Multi Purpose Tray         </div> </div> <div style="display: flex; justify-content: space-around; align-items: center;"> <div style="text-align: center;">  Original         </div> <div style="text-align: center;">  Paper         </div> <div style="text-align: center;">  Finished         </div> <div style="text-align: center;">  Cassette         </div> <div style="text-align: center;">  Multi Purpose Tray         </div> </div> <p><b>Value: Adjust Print Direction, Speed Priority</b></p>

## Media Type Setting

System Menu / Counter

 **Common Settings** ▶ **Paper Settings** ▶ **Media Type Setting**

The following media type and paper weight combinations are available.

Paper Weight	Weight (g/m <sup>2</sup> )	Paper Weight	Weight (g/m <sup>2</sup> )
Light	60 g/m <sup>2</sup> to 63 g/m <sup>2</sup>	Heavy 1	106 g/m <sup>2</sup> to 135 g/m <sup>2</sup>
Normal 1	64 g/m <sup>2</sup> to 74 g/m <sup>2</sup>	Heavy 2	136 g/m <sup>2</sup> to 170 g/m <sup>2</sup>
Normal 2	75 g/m <sup>2</sup> to 90 g/m <sup>2</sup>	Heavy 3	171 g/m <sup>2</sup> to 220 g/m <sup>2</sup>
Normal 3	91 g/m <sup>2</sup> to 105 g/m <sup>2</sup>	Extra Heavy	Transparencies

Each media type's default weight is indicated.

Media Type	Default	Media Type	Default
Plain	Normal 2	Cardstock	Heavy 3
Transparency	Extra Heavy	Color	Normal 3
Rough	Normal 3	Prepunched	Normal 2
Vellum	Light	Letterhead	Normal 3
Labels	Heavy 1	Envelope	Heavy 3
Recycled	Normal 2	Thick	Heavy 3
Preprinted	Normal 2	High Quality	Normal 2
Bond	Normal 3	Custom 1 - 8	Normal 2

For Custom 1-8, settings for duplex printing and media type name can be changed.

Item		Description
<b>Duplex Print</b>	<b>Prohibit</b>	Duplex printing not allowed.
	<b>Permit</b>	Duplex printing allowed.
<b>Name</b>		Change names for Custom 1-8. Names should be not more than 16 characters. Selecting media type at multi purpose tray, the name after change will be displayed.  <a href="#">Character Entry Method (page 11-12)</a>



## Function Defaults

System Menu / Counter

 **Common Settings** ▶ **Function Defaults**

Item	Description
<b>File Format</b>	Select the default type of the files to be sent. <b>Value:</b> PDF, High Comp. PDF, TIFF, JPEG, XPS
<b>Original Orientation</b>	Set the original orientation defaults. <b>Value:</b> Top Edge on Top, Top Edge on Left
<b>Collate</b>	Set the defaults for Collate. <b>Value:</b> Off, On
<b>File Separation</b>	Select the default file separation setting. <b>Value:</b> Off, Each Page
<b>Scan Resolution</b>	Select the default scanning resolution. <b>Value:</b> 600×600dpi, 400×400dpi Ultra Fine, 300×300dpi, 200×400dpi Super Fine, 200×200dpi Fine, 200×100dpi Normal
<b>Color Selection</b>	Select the default color mode for scanning documents. <b>Value:</b> Auto (Color/Gray), Auto Color (Color/B & W), Full Color, Grayscale, Black & White
<b>Original Image (Copy)</b>	Set the default original document type for copying. <b>Value:</b> Text+Photo, Photo, Text, Light Text/Line



Item	Description
<b>Original Image (Send/Store)</b>	Set the default original document type for sending/storing. <b>Value:</b> Text+Photo, Photo, Text, Text (for OCR), Light Text/Line  <b>NOTE</b> [Text (for OCR)] is only available when "Color Selection" is set to [Black & White].
<b>Background Density Adj. (Copy)</b>	Set the default Backgrnd Density (Copy). <b>Value:</b> Off, Auto, Manual (Darker 5)
<b>Background Density Adj. (Send/Store)</b>	Set the default Backgrnd Density (Send/Store). <b>Value:</b> Off, Auto, Manual (Darker 5)
<b>EcoPrint</b>	Select the EcoPrint default. <b>Value:</b> Off, On
<b>Prevent Bleed-through (Copy)</b>	Set the default value for preventing bleed-through (Copy). <b>Value:</b> Off, On
<b>Prevent Bleed-through (Send/Store)</b>	Set the default Prevent Bleed (Send/Store). <b>Value:</b> Off, On
<b>FAX TX Resolution</b>	For details, refer to the <b>FAX Operation Guide</b> .
<b>Zoom</b>	Select the enlarged/reduced default when paper size/sending size changed after the originals set. <b>Value:</b> 100%, Auto
<b>Continuous Scan (Except FAX)</b>	Set the continuous scan defaults. <b>Value:</b> Off, On
<b>Continuous Scan (FAX)</b>	For details, refer to the <b>FAX Operation Guide</b> .
<b>File Name Entry</b>	Set an automatically entered name (default) for jobs. Additional information such as Date and Time and Job No. can also be set. <b>Value</b> <b>File Name:</b> Up to 32 characters can be entered. <b>Additional Info:</b> None, Date and Time, Job No., Job No. & Date and Time, Date and Time & Job No.
<b>E-mail Subject/Body</b>	Set the subject and body automatically entered (default subject and body) when sending the scanned originals by E-mail. <b>Value</b> <b>Subject:</b> Up to 60 characters can be entered. <b>Body:</b> Up to 500 characters can be entered.
<b>FTP Encrypted TX</b>	Set the default value for document encryption during transmission. <b>Value:</b> Off, On  <b>NOTE</b> This setting is displayed when the secure protocol "SSL" setting is [On].
<b>JPEG/TIFF Print</b>	Select the image size (resolution) when printing JPEG or TIFF file. <b>Value:</b> Paper Size, Image Resolution, Print Resolution
<b>XPS Fit to Page</b>	Set the default value for the XPS fit to page function. <b>Value:</b> Off, On

Item	Description
<b>Detail Settings</b>	—
<b>Image Quality</b>	Set the default value for the image quality adjustment range when selecting the file format with which to send and store images. <b>Value:</b> 1 Low (High Comp.), 2, 3, 4, 5 High (Low Comp.)
<b>PDF/A</b>	Set the default value for PDF/A when selecting the file format with which to send and store images. <b>Value:</b> Off, PDF/A-1a, PDF/A-1b
<b>High Comp. PDF</b>	Select the default quality setting for high compressed PDF files. <b>Value:</b> Compression Ratio Priority, Standard, Quality Priority

## Preset Limit

System Menu / Counter



▶ Common Settings ▶ Preset Limit

Item	Description
<b>Preset Limit</b>	Restrict the number of copies that can be made at one time. <b>Value:</b> 1 to 999 copies.

## Error Handling

System Menu / Counter



▶ Common Settings ▶ Error Handling

Item	Description
<b>Duplexing Error</b>	Select what to do when duplex printing is not possible for the selected paper size and media type. <b>Value</b> <b>1-sided: Printed in 1-sided</b> <b>Display Error: Message to cancel printing is displayed.</b>
<b>Paper Mismatch Error</b>	Select what to do when the selected paper size or type does not match paper size or type loaded in the specified paper source while printing from the computer by specifying the cassette or multi-purpose tray. <b>Value</b> <b>Ignore: The setting is ignored and the job is printed.</b> <b>Display Error: Message to cancel printing is displayed.</b>

## Measurement

System Menu / Counter



▶ Common Settings ▶ Measurement

Item	Description
<b>Measurement</b>	Select inch or metric for the unit for paper dimensions. <b>Value:</b> mm, inch

## Low Toner Alert Level

System Menu / Counter



▶ Common Settings ▶ Low Toner Alert Level

Item	Description
<b>Low Toner Alert Level</b>	<p>Set the amount of remaining toner to notify the administrator when to order a toner when the toner is running low.</p> <p><b>Value:</b> Off, On</p> <p> <b>NOTE</b></p> <p>Selecting [Off] alerts you low toner when the amount of remaining toner becomes 5%. If [On] is selected, set the amount of remaining toner to alert. The setting range is 5 to 100% (in 1% increments).</p>

## Keyboard Layout

System Menu / Counter



▶ Common Settings ▶ Keyboard Layout

Item	Description
<b>Keyboard Layout</b>	<p>Change the layout of the touch panel keyboard used to enter characters.</p> <p><b>Value:</b> QWERTY, QWERTZ, AZERTY</p>

## USB Keyboard Type

System Menu / Counter



▶ Common Settings ▶ USB Keyboard Type

Item	Description
<b>USB Keyboard Type</b>	<p>Select the type of USB keyboard that you want to use.</p> <p><b>Value:</b> US-English, US-English with Euro, French, German</p>

## Format SSD

System Menu / Counter



▶ Common Settings ▶ Format SSD

When an optional SSD is inserted into the printer for the first time, it must be formatted before use.



### IMPORTANT

Formatting will destroy any existing data on a storage device including a used SSD.



### NOTE

This function will not be displayed when the optional Data Security Kit is installed.

## Format SD Card

System Menu / Counter



▶ Common Settings ▶ Format SD Card

A new SD card must be formatted before it can be used in the machine.

### ✔ IMPORTANT

- Formatting will destroy any existing data on a storage device including a used SD card.
- If you have installed application, do not format the SD card to avoid the removal of the application in the SD card.

## Display Status/Log

System Menu / Counter



▶ Common Settings ▶ Display Status/Log

Item	Description
<b>Display Status/Log</b>	Set the display method of the Status/Log.
Display Jobs Detail Status	<b>Value:</b> Show All, My Jobs Only, Hide All
Display Jobs Log	<b>Value:</b> Show All, My Jobs Only, Hide All
Display FAX Log <sup>*1</sup>	<b>Value:</b> Show All, Hide All

\*1 Only on products with the fax function installed.

## Function Key Usage

System Menu / Counter



▶ Common Settings ▶ Function Key Usage

Item	Description
<b>Function Key Usage</b>	Select whether to enable the Copy Key, Send Key, and FAX Key on the operation panel.
Copy Key	<b>Value:</b> Disable, Enable
Send Key	<b>Value:</b> Disable, Enable
FAX Key <sup>*1</sup>	<b>Value:</b> Disable, Enable

\*1 Only on products with the fax function installed.

## Home

System Menu / Counter



▶ Home

Configure settings for Home screen.



[Editing the Home Screen \(page 3-5\)](#)

# Copy

System Menu /  
Counter
 **Copy**



Configures settings for copying functions.

Item	Description
<b>Auto Paper Selection</b>	<p>If [Auto] is selected for Paper Selection, set the paper size selection method when the zoom changes.</p> <p><b>Value</b></p> <p><b>Most Suitable Size:</b> Select paper based on the current zoom and the size of the original.</p> <p><b>Same as Original Size:</b> Select paper that matches the size of the original, regardless the zoom.</p>
<b>Auto % Priority</b>	<p>When a paper source of different size from the original is selected, select whether automatic zoom (reduce/zoom) is performed.</p> <p><b>Value:</b> Off, On</p>
<b>Reserve Next Priority</b>	<p>Specify whether the default screen appears when a subsequent copy job is reserved while printing is in progress. To have the default screen appear, select [On].</p> <p><b>Value:</b> Off, On</p>
<b>DP Read Action</b>	<p>When the document processor is used, select the scanning operation for the document processor.</p> <p><b>Value</b></p> <p><b>Speed Priority:</b> Gives priority to scanning speed.</p> <p><b>Quality Priority:</b> Gives priority to image quality at a slightly slower scan speed.</p>

# Send

System Menu /  
Counter
 **Send**

Configures settings for sending functions.

Item	Description
<b>Dest. Check before Send</b>	When performing sending jobs, display the confirmation screen of destinations after pressing the <b>[Start]</b> key. <sup>*1</sup> <b>Value: Off, On</b>
<b>Entry Check for New Dest.</b>	When adding new destination, display the entry check screen to check the entered destination. <sup>*1</sup> <b>Value: Off, On</b>
<b>Send and Forward</b>	Set whether to send the original to another destination and store it when sending images.
<b>Forward</b>	Set the rule to send the original. Multiple rules can be selected. <b>Value: Off, On</b>  <b>NOTE</b> When selecting [On], select rules to forward from [FAX] <sup>*2</sup> , [E-mail], [Folder (SMB)] and [Folder (FTP)].
<b>Destination</b>	Set the destination to which the original is forwarded. One destination can be set. Follow the steps below to register the destination. <ul style="list-style-type: none"> <li>• Address Book</li> <li>• Ext. Address Book</li> <li>• Address Entry (E-mail)</li> <li>• Address Entry (folder)</li> </ul>  <a href="#">Specifying Destination (page 5-22)</a>
<b>Color TIFF Compression</b>	Select the compression method for TIFF images handled on this machine. <b>Value: TIFF V6, TTN2</b>
<b>Default Screen</b>	Use this procedure to set the default screen displayed when you press the <b>[Send]</b> key. <b>Value: Destination, Address Book, Ext. Address Book, One Touch</b>
<b>New Destination Entry</b>	Select whether to permit direct entry of destination. <sup>*1</sup> <b>Value: Prohibit, Permit</b>
<b>Recall Destination</b>	Select whether to permit usage of [Recall] on the Send screen. <sup>*1</sup> <b>Value: Prohibit, Permit</b>



\*1 Also applies when sending the fax.

\*2 Only on products with the fax function installed.

## Document Box

System Menu /  
Counter

### Document Box

Item	Description
<b>Custom Box</b>	Configure settings for Custom Box.
Add/Edit Box	For details, refer to <a href="#">Using a Custom Box on page 5-43</a> .
Default Setting	Auto File Deletion Time Set the time to automatically delete stored documents.
<b>Sub Address Box<sup>*1</sup></b>	For details, refer to the <b>FAX Operation Guide</b> .
<b>Job Box</b>	Configure settings for Job Box.
Quick Copy Job Retention	To maintain free space on the box, you can set the maximum number of stored jobs. <b>Value: number between 0 and 300</b>   <b>NOTE</b> When 0 is set, Quick Copy cannot be used.
Deletion of Job Retention	This setting specifies that documents, such as Private Printing, Quick Copying, or Proof and Hold Printing, saved temporarily in the job box are automatically deleted after they have been saved for a set time. <b>Value: Off, 1 hour, 4 hours, 1 day, 1 week</b>   <b>NOTE</b> This function is valid for documents saved after the function is set. Regardless of this function setting, temporary documents are deleted when the main power switch is turned off.
Storage Media	Select which storage media to use. <b>Value: SSD, SD Card</b>   <b>NOTE</b> This setting is not displayed if the optional SSD or SD card is not installed.
<b>Polling Box<sup>*1</sup></b>	For details, refer to the <b>FAX Operation Guide</b> .

\*1 Only on products with the fax function installed.

## FAX

System Menu /  
Counter

### FAX

Configure settings for FAX. For details, refer to the **FAX Operation Guide**.

## Application

System Menu / Counter

▶ **Application**

Configure settings for Application.

Item	Description
<b>Application</b>	You can install, activate, deactivate, and install applications. For details, refer to <a href="#">Application on page 5-11</a> .

## Internet

System Menu / Counter

▶ **Internet**

Set the proxy for connection to the Internet from an application.

Item	Description
<b>Proxy</b>	Specify the proxy settings. <b>Value:</b> Off, On
<b>Use Same Proxy</b>	Set whether or not the same proxy server is used for all protocols. If the same proxy server is not used, select [Off]. <b>Value:</b> Off, On
<b>HTTP Proxy Server</b>	Set a proxy server (HTTP). <b>Value:</b> (Enter the proxy address and port number.)
<b>HTTPS Proxy Server</b>	Set a proxy server (HTTPS). This setup is available when [Use Same Proxy] is [Off]. <b>Value:</b> (Enter the proxy address and port number.)
<b>No Proxy Domains</b>	Set domains for which no proxy is used. <b>Value:</b> (Enter the domain name.)

## Address Book/One Touch

### Address Book

System Menu / Counter

▶ **Address Book/One Touch** ▶ **Address Book**

Configure settings for address book.



[Adding a Destination \(Address Book\) \(page 3-35\)](#)



## One Touch Key

System Menu / Counter



▶ Address Book/One Touch ▶ One Touch Key

Configure settings for One Touch Key.



[Adding a Destination on One Touch Key \(One Touch Key\) \(page 3-41\)](#)

## Address Book Defaults

System Menu / Counter



▶ Address Book/One Touch ▶ Address Book Defaults

Item	Description
Sort	Select the default sort setting of the address for the address book. <b>Value:</b> No., Name

## Print list

System Menu / Counter



▶ Address Book/One Touch ▶ Print list

For details, refer to the **FAX Operation Guide**.

## User Login/Job Accounting

System Menu / Counter



▶ User Login/Job Accounting

Configure settings related to machine management.



[Overview of User Login Administration \(page 9-2\)](#)

[Overview of Job Accounting \(page 9-32\)](#)

[Unknown ID Job \(page 9-50\)](#)



# Printer



System Menu / Counter



## Printer

Printing from computers, settings are generally made on the application software screen. However, the following settings are available for configuring the defaults to customize the machine.

Item	Description
<b>Emulation</b>	<p>Select the emulation for operating this machine by commands oriented to other types of printers.</p> <p><b>Value:</b> Line Printer, IBM Proprinter, EPSON LQ-850, PCL6, KPDL, KPDL (Auto)</p> <p> <b>NOTE</b></p> <p>When you have selected [KPDL (Auto)], set "Alt Emulation", too.</p> <p>When you have selected [KPDL] or [KPDL (Auto)], set "KPDL Error Report", too.</p>
<b>Alt Emulation</b>	<p>When you have selected [KPDL (Auto)] as emulation mode, you can switch between KPDL and another emulation mode (alternative emulation) automatically according to the data to print.</p> <p><b>Value:</b> Line Printer, IBM Proprinter, EPSON LQ-850, PCL6</p>
<b>KPDL Error Report</b>	<p>When an error has occurred during printing in KPDL emulation mode, set whether or not the error report is output.</p> <p><b>Value:</b> Off, On</p>
<b>EcoPrint</b>	<p>EcoPrint conserves toner when printing. This is recommended for test copies where faded printing is not a problem.</p> <p><b>Value:</b> Off, On</p>
<b>Override A4/Letter</b>	<p>Select whether to treat A4 size and Letter, which are similar in size, as the same size when printing.</p> <p><b>Value</b></p> <p><b>Off:</b> A4 and Letter are not regarded as the same in size.</p> <p><b>On:</b> A4 and Letter are regarded as the same in size. The machine will use whichever size is in the paper source.</p>
<b>Duplex</b>	<p>Select binding orientation for duplex mode.</p> <p><b>Value:</b> 1-sided, 2-sided Bind LongEdge, 2-sided Bind ShortEdge</p>
<b>Paper Output</b>	<p>Select either the inner tray or the optional Rear Tray for the output stack.</p> <p><b>Value:</b> Inner Tray Face Down, Rear Tray Face Up</p> <p> <b>NOTE</b></p> <p>This function can be used for ECOSYS M3550idn and ECOSYS M3560idn.</p>
<b>Copies</b>	<p>Set the default number of copies, from 1 to 999.</p> <p><b>Value:</b> 1 to 999 copies</p>
<b>Orientation</b>	<p>Set the default orientation, [Portrait] or [Landscape].</p> <p><b>Value:</b> Portrait, Landscape</p>
<b>Wide A4</b>	<p>Turn this to on to increase the maximum number of characters that can be printed in a line for an A4 page (78 characters at 10 pitch) and Letter size page (80 characters at 10 pitch). This setting is only effective in PCL 6 emulation.</p> <p><b>Value:</b> Off, On</p>
<b>Form Feed TimeOut</b>	<p>Receiving print data from the computer, the machine may sometimes wait if there is no information signaling that the last page does not have any more data to be printed. When the preset timeout passes, the machine automatically prints paper. The options are between 5 and 495 seconds.</p> <p><b>Value:</b> 5 to 495 seconds (in 5 second increments)</p>

Item	Description
<b>LF Action</b>	Set the line feed action when the machine receives the line feed code (character code 0AH). <b>Value:</b> LF Only, LF and CR, Ignore LF
<b>CR Action</b>	Set the character return action when the machine receives the character return code (character code 0DH). <b>Value:</b> CR Only, LF and CR, Ignore CR
<b>Job Name</b>	Set whether the job name set in the printer driver is displayed. <b>Value:</b> Off, On  <b>NOTE</b> When selecting [On], select the job name to be displayed from [Job Name], [Job No. & Job Name], or [Job Name & Job No.].
<b>User Name</b>	Set whether the user name set in the printer driver is displayed. <b>Value:</b> Off, On
<b>MP Tray Priority</b>	If paper is set in the MP Tray then it is possible for priority to be given to that MP tray in the paper feed. <b>Value</b> <b>Off:</b> The printer driver settings are followed. <b>Auto Feed:</b> If Auto is selected in the printer driver and there is paper in the MP tray then the paper feed will be from the MP tray. <b>Always:</b> If there is paper in the MP tray then the paper feed will be from the MP tray regardless of what is set in the printer driver.
<b>Paper Feed Mode</b>	While printing from the computer, select how to feed paper when the paper source and type are specified. <b>Value</b> <b>Auto:</b> Search the paper source that matches the selected paper size and type. <b>Fixed:</b> Print on paper loaded in the specified paper source.
<b>Auto cassette Change</b>	Select the following actions when the paper runs out in the paper source while printing. <b>Value:</b> Off, On  <b>NOTE</b> When selecting [On], the machine displays "Add the following paper in cassette #." (# is a cassette number) or "Add the following paper in MP Tray", and stops printing. Load the paper according to the paper source displayed to resume printing. To print from the other paper cassette, press [Paper Selection]. Select the desired paper source. When selecting [Off], the machine continues printing automatically when the other cassette contains the same paper as the currently-used cassette.
<b>Resolution</b>	Set the resolution used for printing. <b>Value:</b> 300 dpi, 600 dpi, Fast1200
<b>KIR</b>	The machine is equipped with the smoothing function, which realizes an excellent output resolution of about 2400 dpi × 600 dpi. <b>Value:</b> Off, On

# System/Network

Configures machine system settings.

## Network

System Menu / Counter





▶ System/Network ▶ Network

Configures network settings.

### Host Name





Item	Description
Host Name	Check the host name of the machine. Host name can be changed from Command Center RX.  <a href="#">Changing Device Information (page 2-39)</a>

### TCP/IP

Item	Description
TCP/IP	Set up TCP/IP to connect to the Windows network. <b>Value: Off, On</b>
IPv4 Settings	Set up TCP/IP (IPv4) to connect to the network. This setting is available when [TCP/IP] is set to [On].
DHCP	Select whether or not to use the DHCP (IPv4) server. <b>Value: Off, On</b>
Auto-IP	Select whether to use Auto-IP. <b>Value: Off, On</b>
IP Address	Set the IP addresses. <b>Value: ###.###.###.###</b>  <b>NOTE</b> When DHCP is set to [On], this function will be grayed out and the value cannot be entered.
Subnet Mask	Set the IP subnet masks. <b>Value: ###.###.###.###</b>  <b>NOTE</b> When DHCP is set to [On], this function will be grayed out and the value cannot be entered.
Default Gateway	Set the IP gateway addresses. <b>Value: ###.###.###.###</b>  <b>NOTE</b> When DHCP is set to [On], this function will be grayed out and the value cannot be entered.

### IMPORTANT

After changing the setting, restart the network or turn the machine OFF and then ON.

Item	Description
<b>IPv6 Settings</b>	Set up TCP/IP (IPv6) to connect to the network. This setting is available when [TCP/IP] is [On].
<b>IPv6</b>	Select whether to use IPv6. <b>Value: Off, On</b>  <b>NOTE</b> Selecting [On] displays IP address in [IP Address (Link Local)] after restarting the network.
<b>Manual Setting</b>	Manually specify the IP address, prefix length, and gateway address of TCP/IP (IPv6). <b>Value</b> <b>IP Address (Manual): (numbers (128 bit in total) separated by colons)</b> <b>Prefix Length: 0 to 128</b> <b>Default Gateway: ###.###.###.###</b>  <b>NOTE</b> This function is displayed when [IPv6] is set to [On]. To enter "Default Gateway", set [RA (Stateless)] to [Off].
<b>RA (Stateless)</b>	Select whether to use RA (Stateless). <b>Value: Off, On</b>  <b>NOTE</b> This function is displayed when [IPv6] is set to [On]. Selecting [On] displays IP address in [IP Address (Stateless)] after restarting the network.
<b>DHCP</b>	Select whether to use the DHCP (IPv6) server. <b>Value: Off, On</b>  <b>NOTE</b> This function is displayed when [IPv6] is set to [On]. Selecting [On] displays IP address in [IP Address (Stateful)] after restarting the network.
<b>Bonjour</b>	Select whether or not to use Bonjour. <b>Value: Off, On</b>



**IMPORTANT**

After changing the setting, restart the network or turn the machine OFF and then ON.

Item	Description
<b>Protocol Detail</b>	—
<b>NetBEUI</b>	Selects whether or not to receive documents using NetBEUI.* <sup>1</sup> <b>Value: Off, On</b>
<b>LPD</b>	Select whether or not to receive documents using LPD as the network protocol.* <sup>1</sup> <b>Value: Off, On</b>
<b>SMTP (E-mail TX)</b>	Select whether or not to send e-mail using SMTP. <b>Value: Off, On</b>
<b>POP3 (E-mail RX)</b>	Select whether or not to receive e-mail using POP3. <b>Value: Off, On</b>
<b>FTP Client (Transmission)</b>	Select whether or not to send documents using FTP. When selecting [On], set the FTP Port Number. Use the FTP default port 21. <b>Value: Off, On, Port 1 - 65535</b>
<b>FTP Server (Reception)</b>	Select whether or not to receive documents using FTP.* <sup>1</sup> <b>Value: Off, On</b>
<b>SMB Client (Transmission)</b>	Select whether or not to send documents using SMB. When selecting [On], set the SMB default Port Number. Use the SMB default port 445. <b>Value: Off, On, Port 1 - 65535</b>
<b>LDAP</b>	Select whether or not to use LDAP. <b>Value: Off, On</b>
<b>SNMP</b>	Select whether or not to communicate using SNMP.* <sup>1</sup> <b>Value: Off, On</b>
<b>SNMPv3</b>	Select whether or not to communicate using SNMPv3.* <sup>1</sup> <b>Value: Off, On</b>
<b>HTTP</b>	Select whether or not to communicate using HTTP.* <sup>1</sup> <b>Value: Off, On</b>
<b>HTTPS</b>	Select whether or not to communicate using HTTPS.* <sup>1</sup> * <sup>2</sup> <b>Value: Off, On</b>
<b>IPP</b>	Select whether or not to communicate using IPP. When selecting [On], set the IPP default Port Number. Use the IPP default port 631.* <sup>1</sup> * <sup>2</sup> <b>Value: Off, On, Port 1 - 32767</b>
<b>IPP over SSL</b>	Select whether or not to use IPP over SSL. When selecting [On], set the IPP over SSL default Port Number. Use the IPP over SSL default port 443.* <sup>1</sup> * <sup>2</sup> <b>Value: Off, On, Port:1 - 32767</b>
<b>Raw Port</b>	Select whether or not to receive documents using Raw Port.* <sup>1</sup> <b>Value: Off, On</b>

\*<sup>1</sup> The setting will be changed after restarting the device or the network for the machine.

\*<sup>2</sup> Set "SSL" to [On] in [Secure Protocol on page 8-31](#).

Item	Description
<b>ThinPrint</b>	Select whether to use ThinPrint. When selecting [On], set the SMB default Port Number. Use the default port 4000.*1 *2 <b>Value: Off, On (Port Number: 1 to 32767)</b>
	 <b>NOTE</b> This function is displayed only when the optional ThinPrint Option is activated.
<b>ThinPrintOver SSL</b>	To use Thin Print over SSL, press [Thin Print over SSL] and select [On]. <b>Value: Off, On</b>
	 <b>NOTE</b> When selecting [On], the certificates must be installed. For details, refer to the <b>Command Center RX User Guide</b> .

\*1 The setting will be changed after restarting the device or the network for the machine.

\*2 Set "SSL" to [On] in [Secure Protocol on page 8-31](#).

### WSD Scan

Item	Description
<b>WSD Scan</b>	Select whether or not to use WSD Scan.*1 <b>Value: Off, On</b>

\*1 The setting will be changed after restarting the device or the network for the machine.

### WSD Print

Item	Description
<b>WSD Print</b>	Set whether to use our proprietary web services. WIA driver, TWAIN driver and Network FAX driver use this Enhanced WSD web service.*1 <b>Value: Off, On</b>

\*1 The setting will be changed after restarting the device or the network for the machine.

### Enhanced WSD

Item	Description
<b>Enhanced WSD</b>	Set whether to use our proprietary web services.*1 <b>Value: Off, On</b>
	 <b>NOTE</b> Selecting [Off] will disable the functionality of WIA, TWAIN, and Network FAX driver.

\*1 The setting will be changed after restarting the device or the network for the machine.

### Enhanced WSD (SSL)

Item	Description
<b>Enhanced WSD (SSL)</b>	Set whether to use our proprietary web services over SSL.*1 *2 <b>Value: Off, On</b>
	 <b>NOTE</b> Selecting [Off] will disable the functionality of WIA, TWAIN, and Network FAX driver.

\*1 The setting will be changed after restarting the device or the network for the machine.

\*2 Set "SSL" to [On] in [Secure Protocol on page 8-31](#).

**✔ IMPORTANT**

After changing the setting, restart the network or turn the machine OFF and then ON.

**IPSec**

Item	Description
IPSec	Make this setting when you use IPSec. <sup>*1</sup> <b>Value: Off, On</b>

\*1 The setting will be changed after restarting the device or the network for the machine.

**Secure Protocol**

Item	Description
SSL	Select whether or not to use SSL. <b>Value: Off, On</b>
IPP Security	Select the IPP security level. This setup is available when SSL is [On]. <b>Value: IPP/IPP over SSL, IPPoverSSL only</b>
HTTP Security	Select the HTTP security level. This setup is available when SSL is [On]. <b>Value: HTTP/HTTPS, HTTPS Only</b>
LDAP Security (Ext. Address Book)	Select the type of encryption according to the type of security employed by the LDAP server. This setup is available when SSL is [On]. <sup>*1</sup>
LDAP Security (User Property)	<b>Value: Off, SSL/TLS, STARTTLS</b>
SMTP Security	Select the communication protocol according to the type of security employed by the SMTP server. This setup is available when SSL is [On]. <b>Value: Off, SSL/TLS, STARTTLS</b>
POP3 Security (User 1)	Select the communication protocol according to the type of security employed by the POP3 server. This setup is available when POP3 is [On].
POP3 Security (User 2)	<b>Value: Off, SSL/TLS, STARTTLS</b>
POP3 Security (User 3)	

\*1 LDAP must be set to [On] in [Protocol Detail on page 8-29](#).

**LAN Interface**

Item	Description
LAN Interface	Specify the settings for the LAN interface to be used. <b>Value: Auto, 10Base-Half, 10Base-Full, 100Base-Half, 100Base-Full, 1000BASE-T</b>

**✔ IMPORTANT**

After changing the setting, restart the network or turn the machine OFF and then ON.

**Restart Network**

Item	Description
Restart Network	Restarts the network.





**Proxy**

Item	Description
<b>Proxy</b>	Set the proxy for connection to the Internet from an application. <b>Value: Off, On</b>
<b>Use the Same Proxy Server for All Protocols</b>	Set whether the same proxy server is used for all protocols. To use the same proxy server, select the [Use the Same Proxy Server for All Protocols] checkbox.
<b>Proxy Server (HTTP)</b>	Set a proxy server (HTTP). <b>Value: (Enter the proxy address and port number.)</b>
<b>Proxy Server (HTTPS)</b>	Set a proxy server (HTTPS). This setup is available when "Use the Same Proxy Server for All Protocols" is [Off]. <b>Value: (Enter the proxy address and port number.)</b>
<b>Do Not Use Proxy for Following Domains</b>	Set domains for which no proxy is used. <b>Value: (Enter the domain name.)</b>

**Optional Network**System Menu /  
Counter▶ **System/Network** ▶ **Optional Network** **NOTE**

This function is displayed when the optional Network Interface Kit or Wireless Network Interface Kit is installed.

**Basic**

Item	Description
<b>Host Name</b>	Check the host name of the machine. Host name can be changed from Command Center RX.  <a href="#">Changing Device Information (page 2-39)</a>
<b>TCP/IP Setting</b>	For details on setting value, refer to <a href="#">TCP/IP on page 8-27</a> .
<b>LAN Interface</b>	Select the LAN Interface type.* <sup>1</sup> <b>Value: Auto, 10BASE-T Half, 10BASE-T Full, 100BASE-T Half, 100BASE-T Full, 1000BASE-T</b>  <b>NOTE</b> This function is displayed when the optional Network Interface Kit is installed.
<b>MAC Address Filter</b>	Select whether to use MAC Address Filter. See the Operation Guide for the optional Network Interface Kit for details. <b>Value: Off, On</b>
<b>Restart Network</b>	Restarts the network card of the device.

\*1 The setting will be changed after restarting the device or network.

## Wireless Network

**NOTE**

This function is displayed when the optional Wireless Network Interface Kit is installed.

Item	Description
<b>Connection Status</b>	When the optional Wireless Network Interface Kit is installed, you can check the wireless LAN status.
<b>Quick Setup Wizard</b>	If the machine will connect to an access point that supports the automatic wireless network setup, connection settings can be configured by Quick Setup.
<b>Available Network</b>	Displays access points to which the machine can connect.
<b>Push Button Method</b>	If the access point supports the push button method, wireless settings can be configured using the push button. This setting executes push button, and the connection is started by pressing the push button on the access point.  <b>NOTE</b> The push button method supports only the WPS (WiFi Protected Setup).
<b>PIN Code Method (Device)</b>	Starts connection using the machine's PIN code. Enter the PIN code into the access point. The PIN code of the machine is automatically generated.
<b>PIN Code Method (Terminal)</b>	Starts connection using the PIN code of the access point. Enter the PIN code of the access point.
<b>Custom Setup</b>	The detailed settings for wireless LAN can be changed.
<b>Network Name (SSID)</b>	Set the SSID (Service Set Identifier) of the wireless LAN to which the machine connects.  <b>NOTE</b> Up to 32 characters can be entered.
<b>Connection Mode</b>	Set the connection mode. <b>Value: Ad Hoc, Infrastructure</b>  <b>NOTE</b> <b>Ad Hoc:</b> Directly communicates with the device without going through an access point. This method cannot be used to connect to two or more devices. <b>Infrastructure:</b> Performs communication through an access point.
<b>Channel</b>	Set channel. Use [-] / [+] or the numeric keys to enter a number. <b>Value: 1 to 11</b>
<b>Network Authentication</b>	Select network authentication type. To select other options, open the device home page from a computer. <b>Value: Open, Shared, WPA-PSK<sup>*1</sup>, WPA2-PSK<sup>*1</sup></b>
<b>Encryption</b>	Select encryption method. If the option other than [Disable] is selected, enter the WEP key or the Preshared key. The setting values vary depending on the Network Authentication setting. <b>When Network Authentication is set to [Open] or [Shared]</b> <b>Value: Disable, WEP</b> <b>When Network Authentication is set to [WPA-PSK] or [WPA2-PSK]</b> <b>Value: TKIP<sup>*2</sup>, AES, Auto<sup>*2</sup></b>  <b>NOTE</b> If [WEP] is selected, enter the WEP key. Up to 26 characters can be entered. If [TKIP], [AES] or [Auto] is selected, enter the Preshared key. Enter the value in 8 to 64 characters.

\*1 Not displayed if you selected [Ad Hoc] for "Connection Mode".

\*2 Not displayed if you selected [WPA2-PSK] for "Network Authentication".

## Network Interface (Send)

System Menu /  
Counter

▶ System/Network ▶ Network Interface (Send)



### NOTE

This function is displayed when the optional Network Interface Kit or Wireless Network Interface Kit is installed.

Item	Description
<b>Network Interface (Send)</b>	Specify the network interface card to be used for the send function, the network authentication and connecting to external address book. <b>Value:</b> Standard, Optional Network

## Interface Block Setting

System Menu /  
Counter

▶ System/Network ▶ Interface Block Setting

This allows you to protect this machine by blocking the interface with external devices such as USB hosts or optional interfaces.

Item	Description
<b>USB Host</b>	This locks and protects the USB memory slot (USB host). <b>Value:</b> Unblock, Block
<b>USB Device</b>	This locks and protects the USB interface connector (USB Device). <b>Value:</b> Unblock, Block
<b>USB Storage</b>	This locks and protects the USB memory slot. <b>Value:</b> Unblock, Block  <b>NOTE</b> This function is available when USB Host is set to [Unblock].
<b>Optional Interface 1</b> *1	This locks and protects the optional interface slots. <b>Value:</b> Unblock, Block  <b>NOTE</b> If the machine has two optional interface slots, you can set this feature for each slot.
<b>Optional Interface 2</b> *2	

\*1 [Optional Interface] is displayed on ECOSYS M3040idn.

\*2 Only on products with the fax function installed.



### IMPORTANT

After changing the setting, restart the network or turn the machine OFF and then ON.

## Security Level

System Menu / Counter



▶ System/Network ▶ Security Level

Item	Description
<b>Security Level</b>	<p>Specify the security level.</p> <p><b>Value:</b></p> <p><b>Low:</b> This mode is used during maintenance. Do not use normally.</p> <p><b>High:</b> This is the security setting we recommend. Use this setting normally.</p> <p><b>Very High:</b> In addition to [High] setting, this setting disables the machine settings to be changed from external command.</p>

## Restart

System Menu / Counter



▶ System/Network ▶ Restart

Item	Description
<b>Restart</b>	Restart the CPU without turning the power switch off. Use this to deal with any unstable operation by the machine. (Same as the computer restart.)

## RAM Disk Setting

System Menu / Counter



▶ System/Network ▶ RAM Disk Setting



### NOTE

This function will not be displayed when the optional SSD is installed.

Item	Description
<b>RAM Disk Setting</b>	<p>A RAM disk can be created and its size can be set.</p> <p>Creating a RAM disk makes it possible to print from a Job Box.</p> <p><b>Value</b></p> <p><b>RAM Disk Setting: Off, On</b></p> <p><b>RAM Disk Size: The setting range varies depending on the amount of memory installed and the option memory usage setting.</b></p>



### IMPORTANT

After changing the setting, restart the network or turn the machine OFF and then ON.

## Optional Memory

System Menu / Counter



▶ System/Network ▶ Optional Memory

Item	Description
Optional Memory	When optional memory is installed, select the memory allocation scheme based on the application in which you are using the equipment. <b>Value:</b> Printer Priority, Normal, Copy Priority

### ✔ IMPORTANT

After changing the setting, restart the network or turn the machine OFF and then ON.



## Data Security

System Menu / Counter



▶ System/Network ▶ Data Security

Configure settings for data stored in the optional SSD and machine's memory.

Item	Description
SSD Initialization	Initialize data saved on an optional SSD. For details, refer to the <b>Data Security Kit (E) Operation Guide</b> .   <b>NOTE</b> This function is displayed when the optional SSD is installed and the optional Data Security Kit is activated.
Data Sanitization	Return the following information registered in the machine to the factory defaults. <ul style="list-style-type: none"> <li>• Address Book</li> <li>• Favorites</li> <li>• System settings</li> <li>• Fax transmission and reception / forwarding data</li> <li>• Transmission histories</li> <li>• Data saved in Custom Box</li> <li>• Optional applications</li> </ul>  <b>NOTE</b> Once in progress, the processing cannot be canceled. Before executing this function, disconnect modular, network, and other cables. Do not turn off the main power switch while sanitizing the data. If the main power is turned off during data erasing, erasing will be executed automatically when the power is restored, however, complete erasure cannot be guaranteed.

## Optional Function

System Menu /  
Counter

▶ System/Network ▶ Optional Function





Item	Description
Optional Function	<p>You can use the optional applications installed on this machine.</p> <p> <a href="#">Optional Applications (page 11-10)</a></p>



## Date/Timer/Energy Saver

System Menu /  
Counter

▶ System/Network ▶ Optional Function



Configures settings related to the date and time.

Item	Description
Date/Time	<p>Set the date and time for the location where you use the machine. If you perform Send as E-mail, the date and time set here will be displayed on the header.</p> <p><b>Value:</b> Year (2000 to 2037), Month (1 to 12), Day (1 to 31), Hour (00 to 23), Minute (00 to 59), Second (00 to 59)</p> <p> <a href="#">Setting Date and Time (page 2-11)</a></p> <p> <b>NOTE</b></p> <p>If you change the date/time while using the trial version of an application, you will no longer be able to use the application.</p>
Date Format	<p>Select the display format of year, month, and date. The year is displayed in Western notation.</p> <p><b>Value:</b> Month/Day/Year, Day/Month/Year, Year/Month/Day</p>
Time Zone	<p>Set the time difference from GMT. Choose the nearest listed location from the list. If you select a region that utilizes summer time, configure settings for summer time.</p>
Auto Panel Reset	<p>If no jobs are run for a certain period of time, automatically reset settings and return to the default setting. Select to use Auto Panel Reset or not.</p> <p><b>Value:</b> Off, On</p> <p> <b>NOTE</b></p> <p>The time allowed to elapse before the panel is reset is set with the <a href="#">Panel Reset Timer on page 8-37</a>.</p>
Panel Reset Timer	<p>If you select [On] for Auto Panel Reset, set the amount of time to wait before Auto Panel Reset.</p> <p><b>Value:</b> 5 to 495 seconds (in 5 second increments)</p> <p> <b>NOTE</b></p> <p>This function is displayed when [Auto Panel Reset] is set to [On].</p>
Low Power Timer	<p>Set amount of time before entering the Low Power mode.</p> <p><b>Value</b></p> <p><b>For Europe: 1 to 120 minutes (1 minute increments)</b></p> <p><b>Except for Europe: 1 to 240 minutes (1 minute increments)</b></p> <p> <a href="#">Low Power Mode and Auto Low Power Mode (page 2-14)</a></p>

Item	Description
<b>Sleep Rules (models for Europe)</b>	<p>Select whether to use the Sleep mode for the following functions individually:</p> <ul style="list-style-type: none"> <li>• Network</li> <li>• USB Cable</li> <li>• Card Reader<sup>*1</sup></li> <li>• FAX<sup>*2</sup></li> <li>• Application</li> </ul> <p><b>Value: Off, On</b></p> <p> <b>NOTE</b></p> <p>If the sleep condition is not turned off, the ID card cannot be recognized.</p>
<b>Sleep Level (models except for Europe)</b>	<p>Select the sleep level.</p> <p>Set the Energy Saver mode to reduce power consumption even more than Quick Recovery mode.</p> <p><b>Value: Quick Recovery, Energy Saver</b></p> <p> <b>NOTE</b></p> <p>This function will not be displayed when the optional Network Interface Kit is installed.</p>
<b>Sleep Rules</b>	<p>Select whether to use the Energy Saver mode for the following functions individually:</p> <ul style="list-style-type: none"> <li>• Network</li> <li>• USB Cable</li> <li>• Card Reader<sup>*1</sup></li> <li>• FAX<sup>*2</sup></li> <li>• Application</li> </ul> <p><b>Value: Off, On</b></p> <p> <b>NOTE</b></p> <p>When the machine has entered sleep mode with Energy Saver setting, the ID card cannot be recognized.</p>
<b>Sleep Timer</b>	<p>Set amount of time before entering Sleep.</p> <p><b>Value</b></p> <p><b>For Europe: 1 to 120 minutes (1 minute increments)</b></p> <p><b>Except for Europe: 1 to 240 minutes (1 minute increments)</b></p>

\*1 Displayed when the optional Card Authentication Kit is installed.

\*2 Only on products with the fax function installed.

Item	Description
<b>Power Off Rule</b>	<p>Select whether or not the machine enters Power Off mode for the following function. Select [On] to set the Power Off mode.</p> <ul style="list-style-type: none"> <li>• Network</li> <li>• FAX<sup>*1</sup></li> <li>• USB Cable</li> <li>• USB Host</li> <li>• RAM Disk</li> <li>• NIC<sup>*2</sup></li> <li>• Remote Diagnostics</li> <li>• Application</li> </ul> <p><b>Value:</b> Off, On</p> <p> <b>NOTE</b></p> <p>Even when any of the functions is set to [On], if either [FAX] or [NIC] is set to [Off], the machine does not enter Power Off Mode.</p> <p>When [RAM Disk] is set to [On], even if the data is in the RAM disk, the machine enters Power Off Mode.</p> <p>Even when [Network] or [USB Cable] is set to [Off], if the machine does not communicate with the other devices, the machine will enter Power Off Mode.</p>
<b>Power Off Timer</b>	<p>Select whether to turn off the power automatically after a period of inactivity.</p> <p><b>Value:</b> 1 hour, 2 hours, 3 hours, 4 hours, 5 hours, 6 hours, 9 hours, 12 hours, 1 day, 2 days, 3 days, 4 days, 5 days, 6 days, 1 week</p>
<b>Auto Error Clear</b>	<p>If an error occurs during processing, processing stops to wait for the next step to be taken by the user. In the Auto Error Clear mode, automatically clear the error after a set amount of time elapses.</p> <p><b>Value:</b> Off, On</p>
<b>Error Clear Timer</b>	<p>If you select [On] for Auto Error Clear, set the amount of time to wait before automatically clearing errors.</p> <p><b>Value:</b> 5 to 495 seconds (in 5 second increments)</p> <p> <b>NOTE</b></p> <p>This function is displayed when [Auto Error Clear] is set to [On].</p>
<b>Unusable Time<sup>*1</sup></b>	<p>For details, refer to the <b>FAX Operation Guide</b>.</p>

\*1 Only on products with the fax function installed.

\*2 Displayed when the optional Network Interface Kit or Wireless Network Interface Kit is installed.



## Adjustment/Maintenance

System Menu / Counter



▶ System/Network ▶ Adjustment/Maintenance

Adjust printing quality and conduct machine maintenance.

Item	Description
<b>Quiet Mode Settings</b>	Lower print and scan speed for quiet processing.
<b>Quiet Mode</b>	Set the Quiet Mode. Select this mode when the running noise is uncomfortable. <b>Value: Off, On</b>
<b>Specify for Each Job</b>	It is possible to set the use of Quiet Mode for each job, such as copying and sending. Set whether or not to permit the setting for each job. <b>Value: Permit, Prohibit</b>
<b>Density Adjustment</b>	Adjust density.
<b>Copy</b>	Adjust copy density. Adjustment can be made in 7 levels. <b>Value: -3 (Lighter), -2, -1, 0 (Normal), +1, +2, +3 (Darker)</b>
<b>Send/Box</b>	Adjust scan density when sending or storing the data in Document Box. Adjustment can be made in 7 levels. <b>Value: -3 (Lighter), -2, -1, 0 (Normal), +1, +2, +3 (Darker)</b>
<b>Background Density Adj.</b>	Darkens or lightens overall background density adjustment.
<b>Copy (Auto)</b>	Darkens or lightens overall background density adjustment during copying. Adjustment can be made in 7 levels. <b>Value: -3 (Lighter), -2, -1, 0 (Normal), +1, +2, +3 (Darker)</b>
<b>Send/Box (Auto)</b>	Darkens or lightens overall background density when sending images or storing them in the Document Box. Adjustment can be made in 7 levels. <b>Value: -3 (Lighter), -2, -1, 0 (Normal), +1, +2, +3 (Darker)</b>
<b>Print Density</b>	Adjust print density. Adjustment can be made in 5 levels. <b>Value: 1 to 5</b>
<b>Auto Color Correction</b>	This setting allows you to adjust the detection level used by the machine to determine whether the original is color or black and white during Auto Color Mode. Setting a lower value will result in more originals being identified as color, while a larger value will tend to increase the number of originals being identified as black and white. <b>Value: 1 (Color), 2, 3, 4, 5 (B &amp; W)</b>
<b>Correcting Black Line</b>	Correct fine lines (streaks caused by contamination), which may appear on the image, when the document processor is used. <b>Value</b> <b>Off: No correction performed. Select this when you want to reproduce fine lines in the original more clearly than with [On (Low)].</b> <b>On (Low): Correction performed.</b> <b>On (High): Select this item if a streak remains after using [On (Low)]. The reproduction of fine lines on the original may become lighter than when using On (Low).</b>
<b>Display Brightness</b>	Set the brightness of the touch panel. <b>Value: 1 (Darker), 2, 3, 4, 5 (Lighter)</b>

Item	Description
<b>Drum Refresh</b>	<p>Remove image blur and white dots from the printout. It takes about 3 minutes. The time required may vary depending on the operating environment and this process may take time. For more information, refer to the <a href="#">Drum Refresh on page 10-25</a>.</p> <p> <b>NOTE</b></p> <p>Drum Refresh cannot be performed while printing. Execute Drum Refresh after the printing is done.</p>
<b>Auto Drum Refresh</b>	<p>This machine automatically performs Auto Drum Refresh to keep the best image quality by monitoring its peripheral temperature and humidity. Auto Drum Refresh is performed when the machine is powered on or recovered from Energy Saver mode.</p> <p>Although you can select the time to perform Auto Drum Refresh, normally set it to [Normal]. If [Off] or [Short] is selected, the best image quality may not be kept.</p> <p><b>Value</b></p> <p><b>Off:</b> The Auto Drum Refresh will not be performed.</p> <p><b>Short:</b> Perform Auto Drum Refresh as Short.</p> <p><b>Normal:</b> Perform Auto Drum Refresh as Standard.</p> <p><b>Long:</b> Perform Auto Drum Refresh as Long.</p>

# 9 User Authentication and Accounting (User Login, Job Accounting)

This chapter explains the following topics:

Overview of User Login Administration .....	9-2
Enabling User Login Administration .....	9-3
Setting User Login Administration .....	9-5
Adding a User (Local User List) .....	9-5
Changing User Properties .....	9-9
User Account Lockout Setting .....	9-13
User Login Administration for Printing .....	9-15
To Manage the Users to Scan Using TWAIN .....	9-16
To Manage the Users to Scan Using WIA .....	9-17
To Manage the Users that Send Faxes from a PC .....	9-18
Local Authorization .....	9-19
Group Authorization Settings .....	9-20
Obtain NW User Property .....	9-23
Simple Login Settings .....	9-25
ID Card Settings .....	9-29
Using User Login Administration .....	9-31
Login/Logout .....	9-31
User Login Administration on a PC .....	9-31
Overview of Job Accounting .....	9-32
Enabling Job Accounting .....	9-33
Job Accounting Access .....	9-34
Setting an Account .....	9-35
Adding an Account .....	9-35
Restricting the Use of the Machine .....	9-37
Editing an Account .....	9-38
Deleting an Account .....	9-40
Job Accounting for Printing .....	9-41
Job Accounting for Scan Using TWAIN .....	9-42
Job Accounting for Scan Using WIA .....	9-43
Job Accounting for the FAX Transmitted from a Computer .....	9-44
Configuring Job Accounting .....	9-45
Default Setting .....	9-45
Counting the Number of Pages Printed .....	9-46
Print Accounting Report .....	9-47
Using Job Accounting .....	9-49
Login/Logout .....	9-49
Job Accounting on a PC .....	9-49
Unknown ID Job .....	9-50

# Overview of User Login Administration

User login administration specifies how the user access is administered on this machine. Enter a correct login user name and password for user authentication to login.

- 1 Enable User Login Administration ([page 9-3](#))
- 2 Set the user ([page 9-5](#))
- 3 Enter the login user name and password and execute the job ([page 9-31](#))

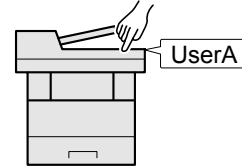
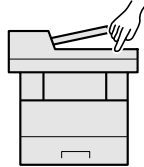

Access are in three levels - "User", "Administrator", and "Machine Administrator". The security levels can be modified only by the "Machine Administrator".

## To manage the job account from PC

In addition to the above settings, the following are necessary to manage the job account from PC.

### To Manage the Users to Print from PCs

Printer driver settings are necessary to manage the users that print on the machine from PCs.

- 1 Set the User Login Administration on the printer driver ([page 9-15](#))
- 2 Print ([page 9-31](#))

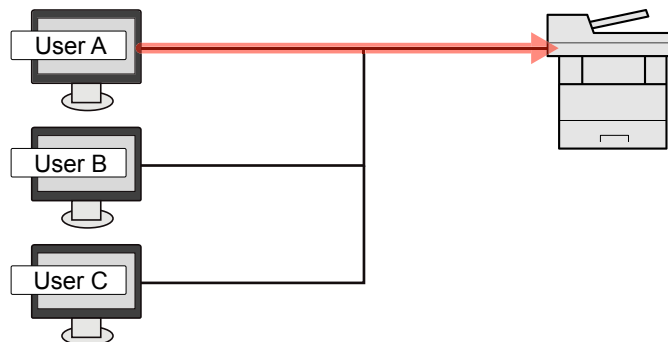

### To Manage the Users to Use TWAIN for Scanning

TWAIN driver settings on the PC are necessary to manage the users that use TWAIN for scanning. (Refer to [To Manage the Users to Scan Using TWAIN on page 9-16.](#))

### To Manage the Users to Use WIA for Scanning

WIA driver settings on the PC are necessary to manage the users that use WIA for scanning. (Refer to [To Manage the Users to Scan Using WIA on page 9-17.](#))

### To Manage the Users to Send Faxes from a PC\*1

FAX driver settings on the PC are necessary to manage the users that send faxes from a PC. (Refer to [To Manage the Users that Send Faxes from a PC on page 9-18.](#))

\*1 Only on products with the fax function installed.

# Enabling User Login Administration

This enables user login administration. Select one of the following authentication methods:

Item	Descriptions
<b>Local Authentication</b>	User authentication based on user properties on the local user list stored in the machine.
<b>Network Authentication</b>	User authentication based on Authentication Server. Use a user property stored in Authentication Server to access the network authentication login page.

## 1 Display the screen.

- 1 Press the [System Menu/Counter] key.

System Menu /  
Counter



- 2 Press [∨] and then [User Login/Job Accounting].

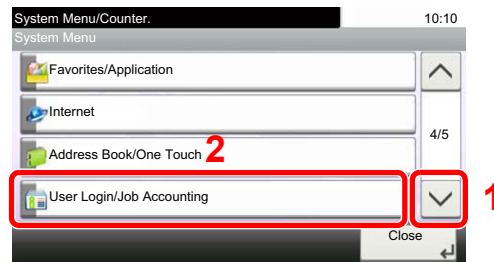

### NOTE

If the login user name entry screen appears during operations, enter a login user name and password, and press [Login].

The factory default login user name and login password are set as shown below.

Model Name	Login User Name	Login Password
<b>ECOSYS M3040idn/ ECOSYS M3540idn</b>	4000	4000
<b>ECOSYS M3550idn</b>	5000	5000
<b>ECOSYS M3560idn</b>	6000	6000

- 3 Press [User Login Setting].

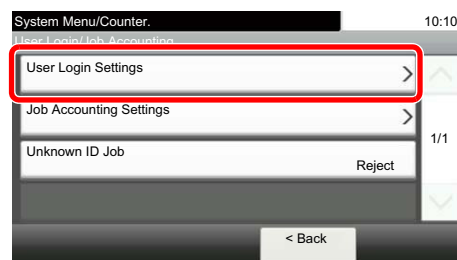

#### 4 Press [User Login].

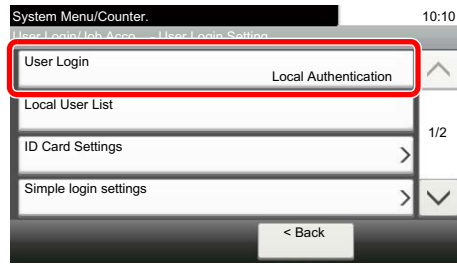

## 2 Configure the settings.



#### 1 Select [Local Authentication] or [Network Authentication].

Select [Off] to disable user login administration.

If you select [Network Authentication], enter the host name (64 characters or less) and domain name (256 characters or less) for the Authentication Server. Select [NTLM], [Kerberos] or [Ext.] as the server type.

When selecting [Ext.] as the server type, enter the port number.



#### NOTE

Pressing [Domain] displays the domain registration list. Enter the domain name. Up to 10 domain names can be registered.

#### 2 “Do you want to add a new function to the home screen?” screen appears. To display a new function on the Home screen, press [Yes] and specify the position in which you want to display the icon of registered function.



[Available Functions to Display on Desktop \(page 3-6\)](#)



#### NOTE

If the login user name and password are rejected, check the following settings.

- Network Authentication setting of the machine
- User property of the Authentication Server
- Date and time setting of the machine and the Authentication Server

If you cannot login because of the setting of the machine, login with any administrator registered in the local user list and correct the settings.

# Setting User Login Administration

This registers, alters and deletes users and configures the settings for User Login Administration.

## Adding a User (Local User List)

This adds a new user. You can add up to 1,000 users (including the default login user name).

### NOTE

By default, one of each default user with machine administrator rights and administrator privileges is already stored. Each user's properties are:

#### Machine Administrator

User Name: DeviceAdmin

Login User Name: ECOSYS M3040idn/ECOSYS M3540idn: 4000, ECOSYS M3550idn: 5000, ECOSYS M3560idn: 6000

Login Password: ECOSYS M3040idn/ECOSYS M3540idn: 4000, ECOSYS M3550idn: 5000, ECOSYS M3560idn: 6000

Access Level: Machine Administrator

#### Administrator

User Name: Admin

Login User Name: Admin

Login Password: Admin

Access Level: Administrator

\* Upper case and lower case letters are distinguished (case sensitive).

It is recommended to periodically change the user name, login user name and login password regularly for your security.

## 1 Display the screen.

- 1 Press the [System Menu/Counter] key.

System Menu /  
Counter



- 2 Press [∨] and then [User Login/Job Accounting].

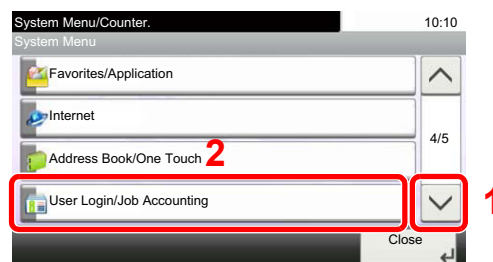

 **NOTE**

If the login user name entry screen appears during operations, enter a login user name and password, and press [Login].

The factory default login user name and login password are set as shown below.

Model Name	Login User Name	Login Password
ECOSYS M3040idn/ ECOSYS M3540idn	4000	4000
ECOSYS M3550idn	5000	5000
ECOSYS M3560idn	6000	6000

3 Press [User Login Setting], [Local User List] and then [+].

**2 Enter the user information.**



When the entry is complete, press [Next] and proceed to the next step. The table below explains the user information to be registered.

Item	Descriptions
<b>User Name</b>	Enter the name displayed on the user list (up to 32 characters).
<b>Login User Name</b>	Enter the login user name to login (up to 64 characters). The same login user name cannot be registered.
<b>Access Level</b>	Select "Administrator" or "User" for user access privileges.



 **NOTE**

Refer to the [Character Entry Method \(page 11-12\)](#) for details on entering characters.



### 3 Check the user information.

Change or add information as needed.

Item	Descriptions
<b>User Name</b> * <sup>1</sup>	Enter the name displayed on the user list (up to 32 characters).
<b>Login User Name</b> * <sup>1</sup>	Enter the login user name to login (up to 64 characters). The same login user name cannot be registered.
<b>Login Password</b>	Enter the password to login (up to 64 characters).
<b>Account Name</b>	<p>Add an account where the user belongs. The user, who registered his/her account name, can login without entering the account ID. Refer to <a href="#">Overview of Job Accounting on page 9-32</a>.</p> <p> <b>NOTE</b>                      Press [Menu] and then [Search (Name)] or [Search (ID)] to search by account name or account ID.                      Press [Menu] and then [Sort (Name)] or [Sort (ID)] to sort the account list.</p>
<b>E-mail Address</b>	The user can register his/her E-mail address. The registered address will be automatically selected for subsequent operations that need any E-mail function.
<b>Access Level</b> * <sup>1</sup>	Select "Administrator" or "User" for user access privileges.
<b>ID Card Information</b>	<p>Register ID card information.                      Place the ID card on the ID card reader, and press [Read].</p> <p> <b>NOTE</b>                      This function is displayed when the optional ID Card Authentication Kit is activated.</p> <p> <a href="#">Card Authentication Kit(B) "Card Authentication Kit" (page 11-3)</a></p>

\*<sup>1</sup> Mandatory at user registration.

Item	Descriptions
<b>My Panel</b>	You can register the language selection, initial screen, and shortcut settings for each user. Settings registered here can be applied simply by logging in.
<b>Local Authorization</b> *1	Set usage authority for each user. The following restriction items are available: <b>Print Restriction:</b> Select whether or not use of the print function of the printer is prohibited. <b>Copy Restriction:</b> Select whether or not use of the copy print function is prohibited. <b>Send Restriction:</b> Select whether or not use of the send function is prohibited. <b>FAX TX Restriction</b> *2: Select whether or not use of the fax send function is prohibited. <b>Storing Restr. in Box:</b> *3 Select whether or not use of the box store function is prohibited. <b>Storing Restr. in Memory:</b> Select whether or not use of the removable memory store function is prohibited.

\*1 Displayed when Local Authorization is enabled. (Refer to [page 9-19](#).)

\*2 Only on products with the fax function installed.

\*3 Displayed when the optional SSD is installed.



#### NOTE

Refer to the [Character Entry Method \(page 11-12\)](#) for details on entering characters.

## 4 Press [Save].

A new user is added on the local user list.



#### NOTE

If simple login is enabled, a confirmation screen appears when new registration is finished asking if you will configure simple login settings. To configure simple login settings, press [Yes]. For the procedure for configuring simple login settings, refer to [Simple Login Settings on page 9-25](#). If you select [No], you will return to the user list screen.

## Changing User Properties

User properties can be changed. Types of user properties that could be changed may be different depending on user access privilege.

### NOTE

To change the user information of the machine administrator, you must log in with machine administrator authority. You can only view user information if you log in as a regular user.

The factory default login user name and login password are set as shown below.

Model Name	Login User Name	Login Password
ECOSYS M3040idn/ECOSYS M3540idn	4000	4000
ECOSYS M3550idn	5000	5000
ECOSYS M3560idn	6000	6000

### For a user with administrator rights who logs in

User properties can be changed and users can be deleted. The items, which can be added, are all able to be changed.

#### 1 Display the screen.

- 1 Press the [System Menu/Counter] key.

System Menu /  
Counter



- 2 Press [∨] and then [User Login/Job Accounting].

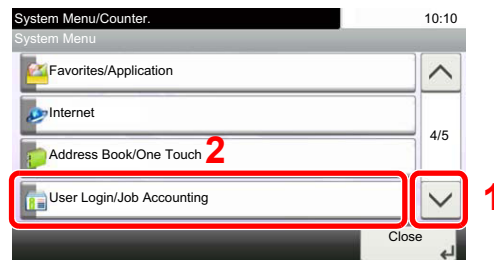

### NOTE

If the login user name entry screen appears during operations, enter a login user name and password, and press [Login].

The factory default login user name and login password are set as shown below.

Model Name	Login User Name	Login Password
ECOSYS M3040idn/ ECOSYS M3540idn	4000	4000
ECOSYS M3550idn	5000	5000
ECOSYS M3560idn	6000	6000

- 3 Press [User Login Setting] and then [Local User List].

## 2 Change the user properties.

### Changing user properties

- 1 Press [  ] for the user to edit.

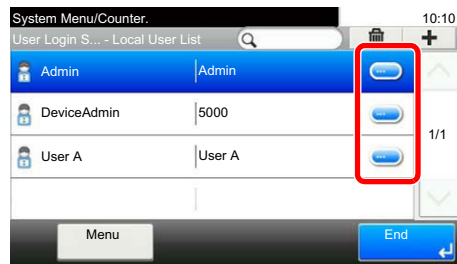

#### NOTE

- Press [Menu] and then [Sort (Name)] and [Sort (Login User Name)] to sort the user list.
- Press [Menu] and then [Search (Name)] or [Search (Login)] to search by name or login user name.

- 2 Refer to step 3 of [Adding a User \(Local User List\)](#) to change a user property.

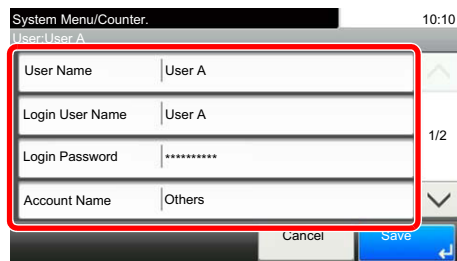

- 3 Press [Save].
- 4 Press [Yes] in the registration confirmation screen.  
The user information is changed.

### Deleting a user

- 1 Select the user to delete and press [  ].
- 2 Press [Yes] in the deletion confirmation screen.  
The selected user will be deleted.

#### NOTE

The default user with administrator rights cannot be deleted.

## To change the user information of logged in user (User Property)

These users can partially change their own user properties including user name, login password, E-mail address, and Simple Login.

Although "Login User Name", "Access Level", or "Account Name" cannot be changed, the users can check the present status.

### 1 Display the screen.

- 1 Press the [System Menu/Counter] key.

System Menu /  
Counter





- 2 Press [∨] and then [User Property].

### 2 Change the user properties.

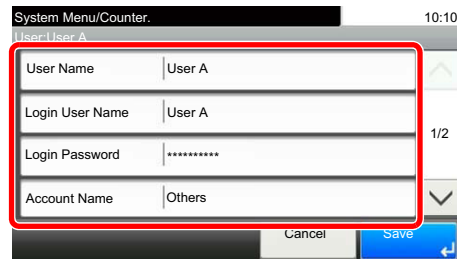
- 1 Refer to step 3 of [Adding a User \(Local User List\)](#) to change a user property.



Item	Description
<b>User Name</b>	Changes the name shown on the user list. Up to 32 characters can be entered.
<b>Login User Name</b>	Displays the login user name that is entered at login.
<b>Login Password</b>	Changes the password that is entered at login. Up to 64 characters can be entered.
<b>Access Level</b>	Displays the user's access level.
<b>Account Name</b>	Displays the account where the user belongs.
<b>E-mail Address</b>	Changes the user's e-mail address. Up to 128 characters can be entered. If you log in as a user and [New Destination Entry] is set to [Prohibit], you can only check the e-mail address.
<b>ID Card Information</b>	Displays the ID card information of the logged in user.  <b>NOTE</b> This function is displayed when the optional ID Card Authentication Kit is activated.  <a href="#">Card Authentication Kit(B) "Card Authentication Kit" (page 11-3)</a> This function does not appear when the server type is set to [Ext.] in Network Authentication, and logged in with the user account certificated in the server specified as the [Ext.] server type.

Item	Description
<b>Simple Login</b>	When simple login is enabled, changes associated settings.  <b>NOTE</b> This function does not appear when Simple Login is set to [Off] or the user is not registered in Simple Login.
<b>My Panel</b>	Register the language, default screen and shortcut for each user. Once registered, the setting will be applied simply by login. Network users are not displayed.
<b>Local Authorization</b> <sup>*1</sup>	Set usage authority for each user. The following restriction items are available: <b>Print Restriction:</b> Select whether or not use of the print function of the printer is prohibited. <b>Copy Restriction:</b> Select whether or not use of the copy print function is prohibited. <b>Send Restriction:</b> Select whether or not use of the send function is prohibited. <b>FAX TX Restriction</b> <sup>*2</sup> : Select whether or not use of the fax send function is prohibited. <b>Storing Restr. in Box:</b> <sup>*3</sup> Select whether or not use of the box store function is prohibited. <b>Storing Restr. in Memory:</b> Select whether or not use of the removable memory store function is prohibited.

\*1 Displayed when Local Authorization is enabled. (Refer to [page 9-19](#).)

\*2 Only on products with the fax function installed.

\*3 Displayed when the optional SSD is installed.

**2** Press [Save].

The user information is changed.

# User Account Lockout Setting

Configure these settings to restrict the operation for the user being authenticated.

## 1 Display the screen.

- 1 Press the [System Menu/Counter] key.

System Menu /  
Counter



- 2 Press [∨] and then [User Login/Job Accounting].

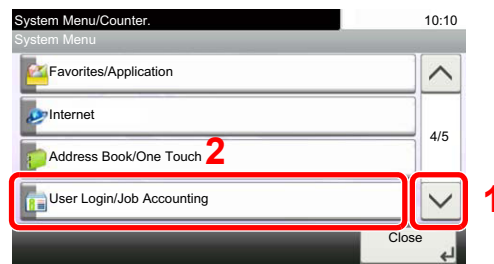

### NOTE

If the login user name entry screen appears during operations, enter a login user name and password, and press [Login].

The factory default login user name and login password are set as shown below.

Model Name	Login User Name	Login Password
ECOSYS M3040idn/ ECOSYS M3540idn	4000	4000
ECOSYS M3550idn	5000	5000
ECOSYS M3560idn	6000	6000

- 3 Press [User Login Setting], [∨] and then [User Account Lockout Settings].

## 2 Configure the settings.

The following settings can be selected.

Item	Descriptions
<b>Lockout</b>	Select whether or not account lockout policy is enabled. <b>Value:</b> Off, On
<b>Lockout Policy</b>	Specify the conditions and the extent to which the account lockout is applied. <b>Value</b> <b>Number of Retries until Locked:</b> Specify how many login retries are allowed until the account is locked out. (1 to 10 times) <b>Lockout Duration:</b> Specify how long the account is to be locked out until it is unlocked. (1 to 60 minutes) <b>Lockout Target</b> Specify the extent to which the account lockout is applied. You can select from [All] or [Remote Login Only]. Remote Login Only locks out all operations from outside the operation panel.
<b>Locked out Users List</b>	Displays a list of locked out users. You can unlock a user by selecting the user in the list, and pressing [Unlock].  <b>NOTE</b> This function is displayed when account lockout policy is enabled.



# User Login Administration for Printing

It is possible to manage the users that print on this machine from a PC.

## Setting Printer Driver

To manage the users that print on this machine from a PC, the following settings are necessary in the printer driver.

### 1 Display the screen.

- 1 Click **[Start]** button on the Windows, and then click **[Devices and Printers]**.

#### NOTE

In Windows 8, select **[Settings]** in charms on Desktop, and select **[Control Panel]**, and then **[Devices and Printers]**.

- 2 Right-click the printer driver icon of the machine, and click the **[Printer properties]** menu of the printer driver.
- 3 Click **[Administrator]** on the **[Device Settings]** tab.

### 2 Configure the settings.

- 1 Select **[User Login]** on the **[User Login]** tab.

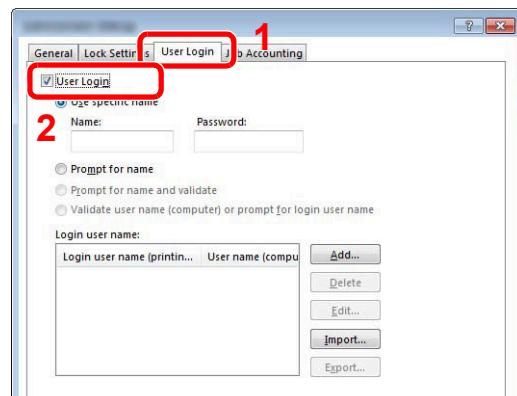

- 2 Set the User Login Administration.

**[Use specific name]:** This option can be used to specify a user name and password to use the same User login for every print job. If this option is selected, the user does not have to type the name and password for each print job.

**[Prompt for name]:** A screen for entering the user name and password will be displayed when attempting a printing. The user name and password must be entered each time a printing is attempted.

**[Prompt for name and validate]:** A screen for entering the user name and password will be displayed when attempting a printing. The user name and password stored in the Login user name list needs to be entered. The user name and password must be entered each time a printing is attempted.

**[Validate user name (computer) or prompt for login user name]:** When printing, the Windows user name is searched in the "Login user names" and printing is possible if the name is registered. If the name is not registered, the printing will be canceled for users with only user authority. If the user has administrator privileges, the screen to enter the user name and password will appear.

- 3 Click **[OK]**.



#### NOTE

For other settings of job accounting, refer to **Printer Driver User Guide**.

## To Manage the Users to Scan Using TWAIN

It is possible to manage the users that scan using TWAIN.

### Setting TWAIN Driver

To manage the users that scan using TWAIN, the following settings are necessary in the TWAIN driver.

#### 1 Display the screen.

- 1 Select **[Start]** button on the Windows, **[All Programs]**, **[Kyocera]** and then **[TWAIN Driver Setting]**. TWAIN Driver screen appears.



#### NOTE

In Windows 8, select **[Search]** in charms, **[Apps]**, and then **[TWAIN Driver Setting]**.

- 2 Click **[Edit]**.

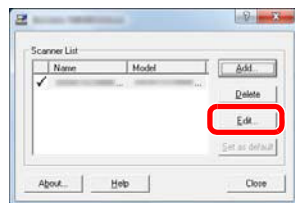

#### 2 Configure the settings.

- 1 Click **[User Authentication Settings]**.
- 2 Select the checkbox beside **[Authentication]**, and enter Login User Name and Password.

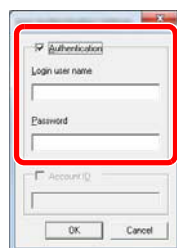

- 3 Click **[OK]**.

## To Manage the Users to Scan Using WIA

It is possible to manage the users that scan using WIA.

### Setting WIA Driver

To manage the users that scan using WIA, the following settings are necessary in the WIA driver.

#### 1 Display the screen.

- 1 Click **[Start]** button on the Windows and enter **[Scanner]** in **[Program and File Search]**. Click **[View scanners and cameras]** in the search list then the Scanners and Cameras screen appears.

#### NOTE

In Windows 8, click **[Search]** in charms, and then **[Settings]**, and enter "Scanner" in the search box. Click **[View scanners and cameras]** in the search list then the Scanners and Cameras screen appears.

- 2 Select the same name as this machine from WIA Drivers, and press **[Properties]**.

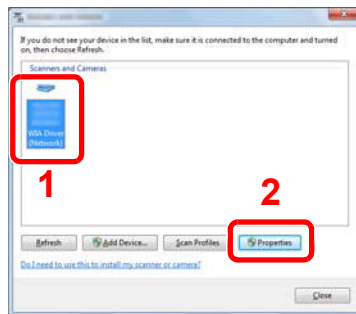

#### 2 Configure the settings.

- 1 Select the checkbox beside **[Authentication]** on the **[Settings]** tab, and enter Login User Name and Password.

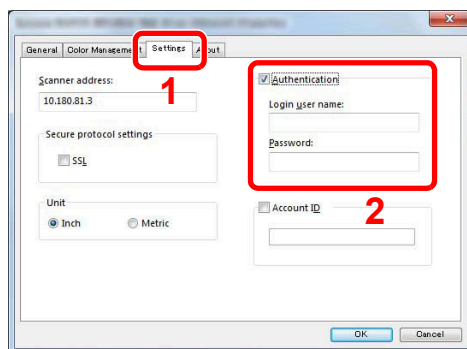

- 2 Click **[OK]**.

## To Manage the Users that Send Faxes from a PC

It is possible to manage the users that send faxes from a PC.

### Setting FAX Driver

To manage the users that send faxes from a PC, the following settings are necessary in the FAX driver.

#### 1 Display the screen.

- 1 Click **[Start]** button on the Windows, and then click **[Devices and Printers]**.

#### NOTE

In Windows 8, select **[Settings]** in charms on Desktop, and select **[Control Panel]**, and then **[Devices and Printers]**.

- 2 Right-click the printer driver icon of the machine, and click the **[Printer properties]** menu of the printer driver.
- 3 Click **[FAX TX Setting]** on the **[Printing Preferences]** window.

#### 2 Configure the settings.

- 1 Select **[User Login]** on the **[Authentication]** tab.

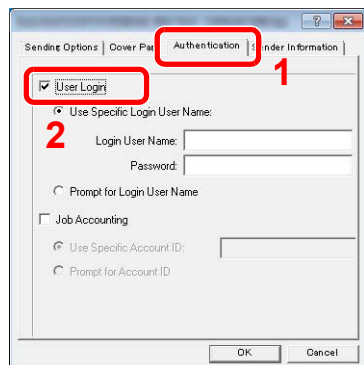

- 2 Set the User Login Administration.

**[Use Specific Login User Name]:** This option can be used to specify a user name and password to use the same User login for every FAX job. If this option is selected, the user does not have to type the name and password for each FAX job.

**[Prompt for Login User Name]:** A screen for entering the user name and password will be displayed when attempting a transmission. The user name and password must be entered each time a transmission is attempted.

- 3 Click **[OK]**.

# Local Authorization

Select whether or not to use Local Authorization.

 **NOTE**

When using Local Authorization, the user authentication type must be set to [Local Authentication].  
For details, refer to [Enabling User Login Administration on page 9-3](#).

## 1 Display the screen.

- 1 Press the [**System Menu/Counter**] key.

System Menu /  
Counter



- 2 Press [∨] and then [User Login/Job Accounting].

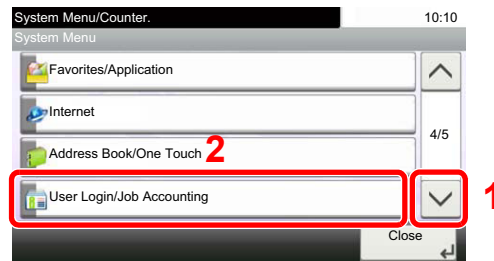

 **NOTE**

If the login user name entry screen appears during operations, enter a login user name and password, and press [Login].

The factory default login user name and login password are set as shown below.

Model Name	Login User Name	Login Password
ECOSYS M3040idn/ ECOSYS M3540idn	4000	4000
ECOSYS M3550idn	5000	5000
ECOSYS M3560idn	6000	6000

- 3 Press [User Login Setting], [∨] and then [Local User Authorization].

## 2 Press [Off] or [On].

## Group Authorization Settings

Set restrictions of the machine usage by each individual group registered in the authentication server.

### NOTE

To use the group authorization settings, [Network Authentication] must be selected for the authentication method in [Enabling User Login Administration on page 9-3](#). Select "On" for "LDAP" in [Protocol Detail on page 8-29](#).

## Group Authorization

Use the group authorization.

### 1 Display the screen.

- 1 Press the [[System Menu/Counter](#)] key.

System Menu /  
Counter



- 2 Press [∨] and then [User Login/Job Accounting].

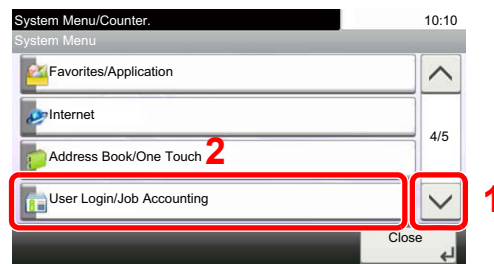

### NOTE

If the login user name entry screen appears during operations, enter a login user name and password, and press [Login].

The factory default login user name and login password are set as shown below.

Model Name	Login User Name	Login Password
ECOSYS M3040idn/ ECOSYS M3540idn	4000	4000
ECOSYS M3550idn	5000	5000
ECOSYS M3560idn	6000	6000

- 3 Press [User Login Setting], [∨] and then [Group Authorization].

### 2 Press [On].

## Group List

Register the groups that are restricted the machine usage. Up to 20 groups can be individually registered. Other users and groups belong to "Others".

The table below explains the group information to be registered.

Item	Descriptions
<b>Group ID</b> <sup>*1</sup>	Enter the ID displayed on the group list (between 1 and 4294967295).
<b>Group Name</b>	Enter the name displayed on the group list (up to 32 characters).
<b>Access Level</b>	Select [Administrator] or [User] for group access privileges.
<b>Print Restriction</b>	Select whether or not to reject usage of print functions for the printer.
<b>Copy Restriction</b>	Select whether or not to reject usage of copy functions.
<b>Send Restriction</b>	Select whether or not to reject usage of the send functions.
<b>FAX TX Restriction</b> <sup>*2</sup>	Select whether or not to reject usage of the FAX transmissions.
<b>Storing Restr. in Box</b> <sup>*3</sup>	Select whether or not to reject usage of storing in the document boxes.
<b>Storing Restr. in Memory</b>	Select whether or not to reject usage of storing in the removable memory.

\*1 For "Group ID", specify PrimaryGroupID assigned by Active Directory of Windows. If you are using Windows Server 2008, check Attribute Editor tab of user properties. If you are using Windows Server 2000/2003, check ADSIEdit. ADSIEdit is a support tool included on the installation DVD for Windows Server OS (under ¥SUPPORT¥TOOLS).

\*2 Only on products with the fax function installed.

\*3 Displayed when the optional SSD is installed.

### 1 Display the screen.

- 1 Press the [System Menu/Counter] key.

System Menu /  
Counter



- 2 Press [∨] and then [User Login/Job Accounting].

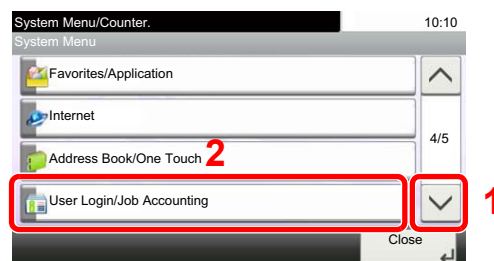

 **NOTE**

If the login user name entry screen appears during operations, enter a login user name and password, and press [Login].

The factory default login user name and login password are set as shown below.

Model Name	Login User Name	Login Password
ECOSYS M3040idn/ ECOSYS M3540idn	4000	4000
ECOSYS M3550idn	5000	5000
ECOSYS M3560idn	6000	6000

- 3 Press [User Login Setting], [ √ ], [Group Authorization], [Group List] and then [ + ].



## 2 Configure the settings.

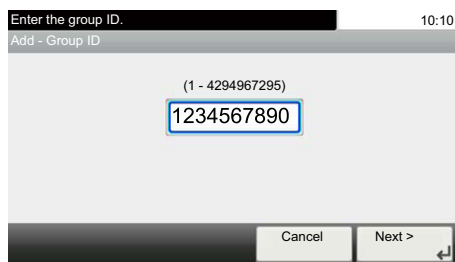

- 1 Enter the group ID and press [Next].
- 2 Enter the group name and press [Next].

 **NOTE**

Refer to [Character Entry Method on page 11-12](#) for details on entering characters.

- 3 Select the group access privileges and press [Next].
- 4 Check the settings and change or add information as needed.

## 3 Register the group.

Press [Save]. A new group is added on the group list.



## Obtain NW User Property

Set the required information to obtain the network user property from the LDAP server. The user name and E-mail address obtained with this setting is shown in the user information, the status confirmation screen, and the header of E-mail.

### NOTE

To obtain the network user property from the LDAP server, [Network Authentication] must be selected for the authentication method in [Enabling User Login Administration on page 9-3](#). Select "On" for "LDAP" in [Protocol Detail on page 8-29](#).

The table below explains the required information to be registered.

Item	Descriptions
<b>Server Name</b> *1	Enter the LDAP server name or the IP address (up to 64 characters). If a server name is not entered, user information will be acquired from the server set for Network Authentication.
<b>Port</b>	Set the LDAP port number or use the default port 389.
<b>Name 1</b> *2	Enter the LDAP Attribute to obtain the user name to be displayed from the LDAP server (up to 32 characters).
<b>Name 2</b> *3	Enter the LDAP Attribute to obtain the user name to be displayed from the LDAP server (up to 32 characters).
<b>E-mail Address</b> *4	Enter the LDAP Attribute to obtain the E-mail address from the LDAP server (up to 32 characters).
<b>Authentic at Type</b> *5	Set the authentication method. Select [Simple] or [SASL]. After changing the setting, restart the system or turn the power off and then on.
<b>Search Timeout</b>	Set the amount of time to wait before time-out in seconds (from 5 to 255 seconds).

\*1 If using Active Directory of Windows, the server name may be the same as the server name entered in the network authentication.

\*2 If using Active Directory of Windows, displayName of Attribute may be used as "Name 1".

\*3 "Name 2" can be left out. When you assign displayName in "Name 1" and department in "Name 2", and if the value of displayName is "Mike Smith" and the value of department is "Sales" in Active Directory of Windows, the user name appears as "Mike Smith Sales".

\*4 If using Active Directory of Windows, mail of Attribute may be used as E-mail Address.

\*5 Appears when the server type is set to "Kerberos" in "Network Authentication".

## 1 Display the screen.

- 1 Press the [System Menu/Counter] key.

System Menu /  
Counter



- 2 Press [∨] and then [User Login/Job Accounting].

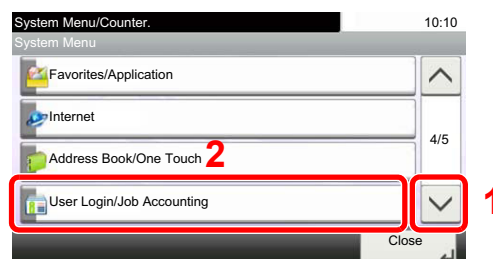

**NOTE**

If the login user name entry screen appears during operations, enter a login user name and password, and press [Login].

The factory default login user name and login password are set as shown below.

Model Name	Login User Name	Login Password
ECOSYS M3040idn/ ECOSYS M3540idn	4000	4000
ECOSYS M3550idn	5000	5000
ECOSYS M3560idn	6000	6000

- 3 Press [User Login Setting], [✓], [Obtain NW User Property] and then [On].

## 2 Configure the settings.

- 1 Press [Server Name].
- 2 Enter the LDAP server name or the IP address and press [OK].
- 3 Press [Port].
- 4 Press [# Keys] to enter the LDAP port number using the numeric keys.
- 5 Press [Name 1].
- 6 Enter the LDAP Attribute to obtain the user name to be displayed and press [OK].
- 7 Similar to steps 5 and 6, set [Name 2].
- 8 If you set the server type to "Kerberos", press [Authentication Type] and set the authentication method.
- 9 Press [E-mail Address].
- 10 Enter the LDAP Attribute to obtain the E-mail address and press [OK].
- 11 Press [Search Timeout] to set the amount of time to wait before time-out.
- 12 Press [+], [-] or the numeric keys to enter the time and press [OK].
- 13 Press [OK].

## Simple Login Settings

The simple login function allows users to log in simply by selecting a user name. Users must be registered in advance to use this functionality.

### NOTE

- For user registration, refer to [Adding a User \(Local User List\) on page 9-5](#).
- To use Simple Login, User Login Administration must be enabled in [Enabling User Login Administration on page 9-3](#).

## Simple Login

Select whether or not simple login is enabled.

### 1 Display the screen.

- 1 Press the [System Menu/Counter] key.

System Menu /  
Counter



- 2 Press [∨] and then [User Login/Job Accounting].

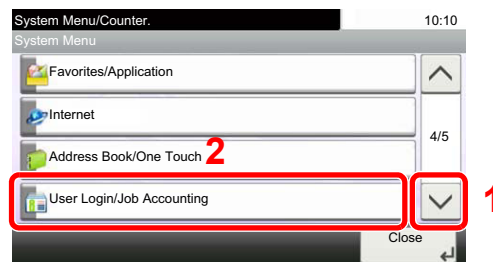

### NOTE

If the login user name entry screen appears during operations, enter a login user name and password, and press [Login].

The factory default login user name and login password are set as shown below.

Model Name	Login User Name	Login Password
ECOSYS M3040idn/ ECOSYS M3540idn	4000	4000
ECOSYS M3550idn	5000	5000
ECOSYS M3560idn	6000	6000

- 3 Press [User Login Setting], [Simple Login Settings] and then [Simple Login].

### 2 Press [On] or [Off].

## Simple Login Setup

Register users to use simple login. You can add up to 20 users.

### 1 Display the screen.

- 1 Press the [System Menu/Counter] key.

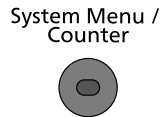

- 2 Press [∨] and then [User Login/Job Accounting].

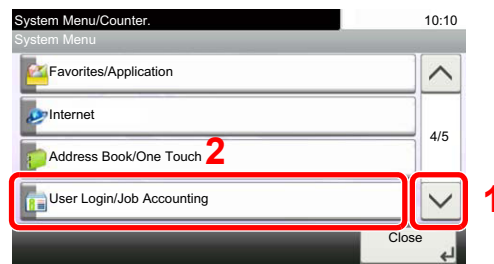

#### NOTE

If the login user name entry screen appears during operations, enter a login user name and password, and press [Login].

The factory default login user name and login password are set as shown below.

Model Name	Login User Name	Login Password
ECOSYS M3040idn/ ECOSYS M3540idn	4000	4000
ECOSYS M3550idn	5000	5000
ECOSYS M3560idn	6000	6000

- 3 Press [User Login Setting], [Simple Login Settings] and then [Simple Login Setup].

### 2 Enter the user information.

- 1 Press the key to which you want to register a user.
- 2 Press [+].

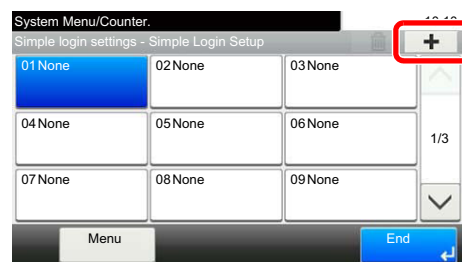

- 3 To specify the user from local users, select [Local User]. To specify from network users, select [Network User].

The procedure differs depending on the transmission method selected.

### Specifying the user from local users

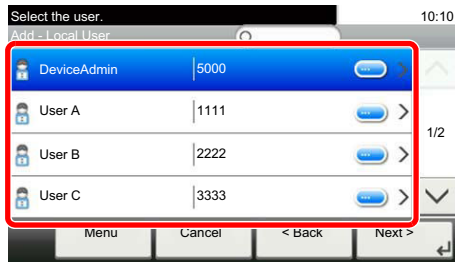

Select the user to be set for simple login.

**NOTE**

- Press [Menu] and then [Sort (Name)] and [Sort (Login User Name)] to sort the user list.
- Press [Menu] and then [Search (Name)] or [Search (Login)] to search by name or login user name.

### Specifying the user from network users



Press [Keyboard] for "Login User Name" and "Login Password", enter the information of the user to be registered, and press [OK].

If you are specifying a user for whom a domain is set in network authentication, press the "Domain" and select the domain where the user is registered.

Press [Next].

**NOTE**

Refer to [Character Entry Method on page 11-12](#) for details on entering characters.

**4** Enter the user name to be displayed, and press [OK].



**NOTE**

Refer to [Character Entry Method on page 11-12](#) for details on entering characters.

**5** Press [Password Login].

**6** Select [On] or [Off].

**7** Press [Icon].

- 8 Select the user icon to be displayed and press [OK].



- 3 **Register the user.**

Press [Save].

## ID Card Settings

If ID card authentication is enabled, select the authentication type.

### NOTE

- This functions appears when the Card Authentication kit is activated.

 [Card Authentication Kit\(B\) "Card Authentication Kit" on page 11-3](#)

- This function does not appear when the user logs in as a network authentication user.

### 1 Display the screen.

- 1 Press the [System Menu/Counter] key.

System Menu /  
Counter



- 2 Press [∨] and then [User Login/Job Accounting].

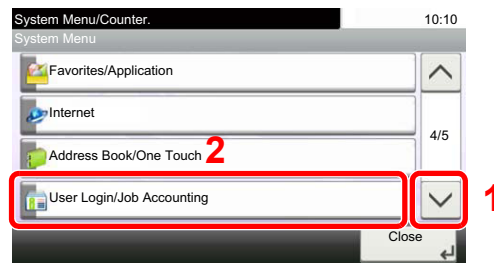

### NOTE

If the login user name entry screen appears during operations, enter a login user name and password, and press [Login].

The factory default login user name and login password are set as shown below.

Model Name	Login User Name	Login Password
ECOSYS M3040idn/ ECOSYS M3540idn	4000	4000
ECOSYS M3550idn	5000	5000
ECOSYS M3560idn	6000	6000

- 3 Press [User Login Setting] and then [ID Card Settings].

## 2 Configure the settings.

The following settings can be selected.

Item	Descriptions
<b>Keyboard Login</b>	When ID card authentication is enabled, select whether or not login by keyboard is allowed. <b>Value: Permit, Prohibit</b>
<b>Password Login</b>	Select whether or not to require password entry after authenticating by ID card. <b>Value: Off, On</b>



# Using User Login Administration

This section explains procedures while setting job accounting.

## Login/Logout

If user login administration is enabled, the login user name and login password entry screen appears each time you use this machine.

Use the procedure below to login and logout.

### Login

If the login user name entry screen appears during operations, log in by referring to [Login/Logout on page 2-9](#).

### Logout

When the operations are complete, press the [**Authentication/Logout**] key to return to the login user name and login password entry screen.

Authentication/  
Logout



## User Login Administration on a PC

If the following screen appears on your computer, enter the login user name and login password, and then click [**OK**].

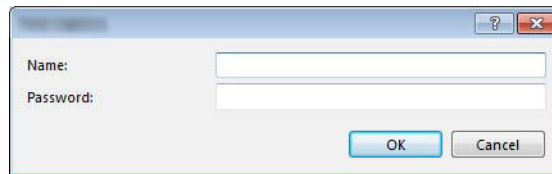

# Overview of Job Accounting

Job accounting manages the copy/print/scan/FAX count accumulated by individual accounts by assigning an ID to each account.

- 1** Enable job accounting. (Refer to [page 9-33.](#))
- 2** Setting an account. (Refer to [page 9-35.](#))
- 3** Enter the assigned account ID when performing the job. (Refer to [Using User Login Administration on page 9-31.](#))
- 4** Count the number of pages copied, printed, scanned and faxed.

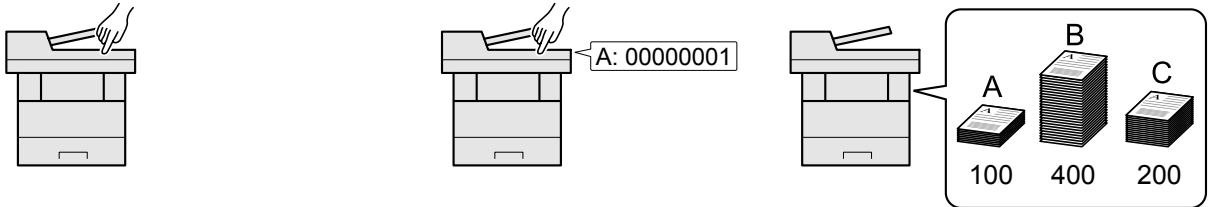

## To manage the job account from PC

In addition to the above settings, the following are necessary to manage the job account from PC.

### To Manage the Number of Sheets Used on Jobs Printed from a PC

To manage the number of jobs to be printed from the PC on the network, you need to configure settings by using the printer driver on the PC.

- 1** Set Job Accounting for the PC on the network by using the printer driver. (Refer to [Job Accounting for Printing on page 9-41.](#))
- 2** Execute printing.
- 3** Count the number of pages printed.

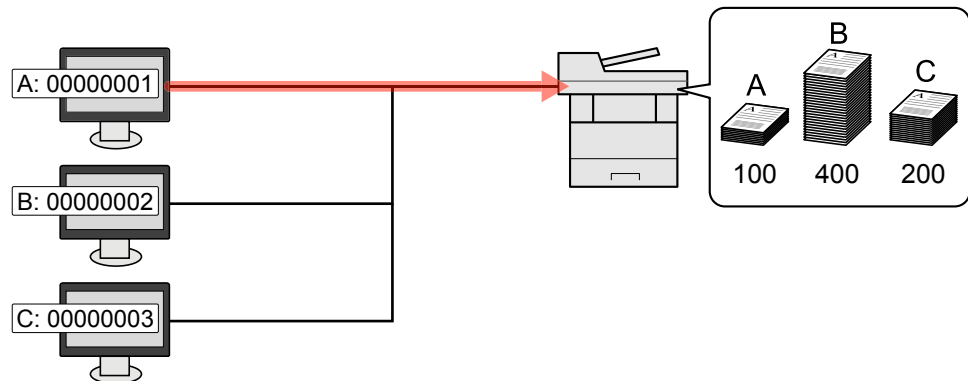

### To Manage the Scan Job Account by Using TWAIN

To manage the scan job account by using TWAIN, you need to configure the TWAIN driver settings on the computer connected to the machine. (Refer to [Job Accounting for Scan Using TWAIN on page 9-42.](#))

### To Manage the Scan Job Account by Using WIA

To manage the scan job account by using WIA, you need to configure the WIA driver settings on the computer connected to the machine. (Refer to [Job Accounting for Scan Using WIA on page 9-43.](#))

### To Manage the FAX Job Transmitted from a PC \*1

To manage the number of FAX jobs transmitted from the PC, you need to configure the settings by using the FAX Driver on the PC. (Refer to [Job Accounting for the FAX Transmitted from a Computer on page 9-44.](#))

\*1 Only on products with the fax function installed.

# Enabling Job Accounting

Enable job accounting. Use the procedure below.

## 1 Display the screen.

- 1 Press the [System Menu/Counter] key.

System Menu /  
Counter



- 2 Press [∨] and then [User Login/Job Accounting].

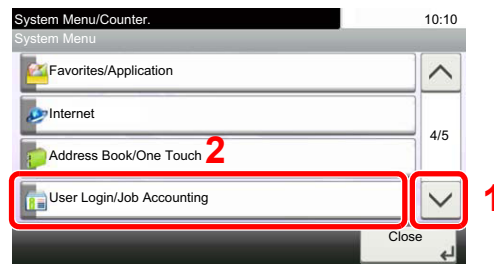

### NOTE

If the login user name entry screen appears during operations, enter a login user name and password, and press [Login].

The factory default login user name and login password are set as shown below.

Model Name	Login User Name	Login Password
ECOSYS M3040idn/ ECOSYS M3540idn	4000	4000
ECOSYS M3550idn	5000	5000
ECOSYS M3560idn	6000	6000

- 3 Press [Job Accounting Settings] and then [Job Accounting].

## 2 Press [On].

### NOTE

- To disable job accounting, press [Off].
- When the display returns to System Menu default screen, logout is automatically executed and the screen to enter the Account ID appears. To continue the operation, enter the Account ID.

# Job Accounting Access

Set the job accounting access.

## 1 Display the screen.

- 1 Press the [System Menu/Counter] key.

System Menu /  
Counter



- 2 Press [∨] and then [User Login/Job Accounting].

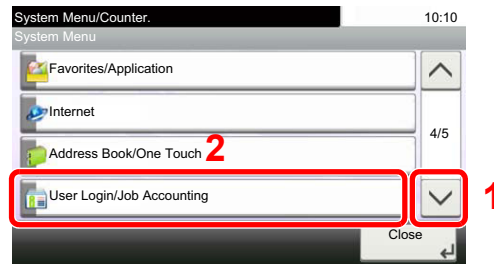

### NOTE

If the login user name entry screen appears during operations, enter a login user name and password, and press [Login].

The factory default login user name and login password are set as shown below.

Model Name	Login User Name	Login Password
ECOSYS M3040idn/ ECOSYS M3540idn	4000	4000
ECOSYS M3550idn	5000	5000
ECOSYS M3560idn	6000	6000

- 3 Press [Job Accounting Settings] and then [Job Accounting Access].

## 2 Configure the settings.

Select [Local] or [Network].

### NOTE

To select [Network], network authentication must be enabled and [Ext.] must be selected for server type.



[Enabling User Login Administration \(page 9-3\)](#)

# Setting an Account

You can add, change and delete an account and set the restriction for each account.

## Adding an Account

Up to 100 individual accounts can be added. The following entries are required.

Item	Descriptions
<b>Account Name</b>	Enter the account name (up to 32 characters).
<b>Account ID</b>	Enter the account ID as many as eight digits (between 0 and 99999999).
<b>Restriction</b>	This prohibits printing/scanning or restricts the number of sheets to load. Refer to <a href="#">Restricting the Use of the Machine on page 9-37</a> .

### 1 Display the screen.

- 1 Press the [System Menu/Counter] key.

System Menu /  
Counter



- 2 Press [∨] and then [User Login/Job Accounting].

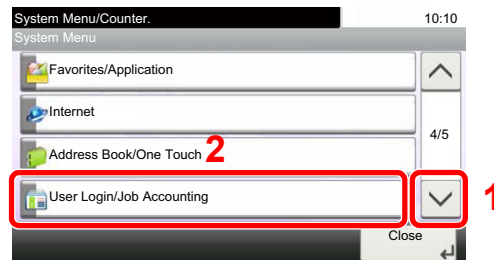

#### NOTE

If the login user name entry screen appears during operations, enter a login user name and password, and press [Login].

The factory default login user name and login password are set as shown below.

Model Name	Login User Name	Login Password
ECOSYS M3040idn/ ECOSYS M3540idn	4000	4000
ECOSYS M3550idn	5000	5000
ECOSYS M3560idn	6000	6000

- 3 Press [Job Accounting Settings], [∨], [Accounting List] and then [+].

## 2 Enter the account information.



The screenshot shows a dialog box titled "Add - Account Name". At the top, the text "AAA" is entered. To the right, it says "Input: 3" and "Limit: 32". Below this is a grid of keys: a row with q, w, e, r, t, y, u, i, o, p; a second row with a, s, d, f, g, h, j, k, l, and a right arrow key; and a third row with @, z, x, c, v, b, n, m, ., and a left arrow key. At the bottom are three buttons: "Cancel", "< Back", and "Next >".

- 1 Enter the account name and press [Next].



### NOTE

Refer to the [Character Entry Method \(page 11-12\)](#) for details on entering characters.

- 2 Enter the account ID and press [Next].



### NOTE

Any "Account ID" that has already registered cannot be used. Enter any other account ID.

- 3 Activate or deactivate restriction.



Refer to [Restricting the Use of the Machine on page 9-37](#).

- 4 Press [Save].

A new account is added on the Account List.

## Restricting the Use of the Machine

This section explains how to restrict the use of the machine by account or the number of sheets available.

The items that can be restricted differ depending on whether "Individual" or "Total" is selected for [Copy/Print Count on page 9-45](#).

### Restriction Items

- "Individual" selected for Copy/Printer Count

Item	Descriptions
<b>Copy (Total)</b>	Limits the number of sheets used for copying.
<b>Printer (Total)</b>	Limits the number of sheets used for printing.
<b>Scan (Others)</b>	Limits the number of sheets scanned (excludes copying).
<b>FAX Transmission</b>	Limits the number of sheets sent by fax. This is displayed only on products with the fax function installed.

- "Total" selected for Copy/Printer Count

Item	Descriptions
<b>Print (Total)</b>	Limits the total number of sheets used for copying and printing.
<b>Scan (Others)</b>	Limits the number of sheets scanned (excludes copying).
<b>FAX Transmission</b>	Limits the number of sheets sent by fax. This is displayed only on products with the fax function installed.

### Applying Restriction

Restriction can be applied in the following modes:

Item	Descriptions
<b>Off</b>	No restriction is applied.
<b>Counter Limit</b>	Restricts the print counter in one-page increments up to 9,999,999 copies.
<b>Reject Usage</b>	Restriction is applied.

## Editing an Account

This changes the registered account information.

### 1 Display the screen.

- 1 Press the [System Menu/Counter] key.

System Menu /  
Counter



- 2 Press [∨] and then [User Login/Job Accounting].

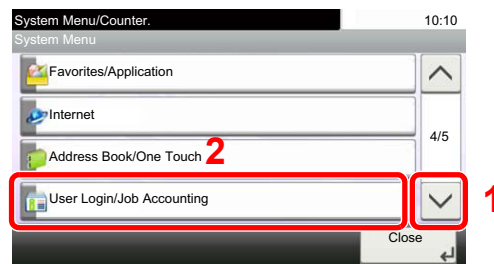

#### NOTE

If the login user name entry screen appears during operations, enter a login user name and password, and press [Login].

The factory default login user name and login password are set as shown below.

Model Name	Login User Name	Login Password
ECOSYS M3040idn/ ECOSYS M3540idn	4000	4000
ECOSYS M3550idn	5000	5000
ECOSYS M3560idn	6000	6000

- 3 Press [Job Accounting Settings], [∨] and then [Accounting List].

### 2 Edit an account.

- 1 Press [] for the account name you wish to edit.

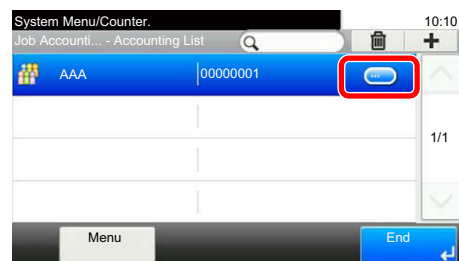

#### NOTE

- Press [Menu] and then [Search (Name)] or [Search (ID)] to search by name or login user name.
- Press [Menu] and then [Sort (Name)] and [Sort (ID)] to sort the user list.



- 2 Select the account information to be changed and change the account information.

Account:AAA	
Account Name	AAA
Account ID	00000001
Print (Total)	Off
Scan (Others)	Off

Cancel Save

- 3 Press [Save].
- 4 Press [Yes] in the registration confirmation screen.  
The account information is changed.

## Deleting an Account

This deletes the account.

### 1 Display the screen.

- 1 Press the [System Menu/Counter] key.

System Menu /  
Counter



- 2 Press [∨] and then [User Login/Job Accounting].

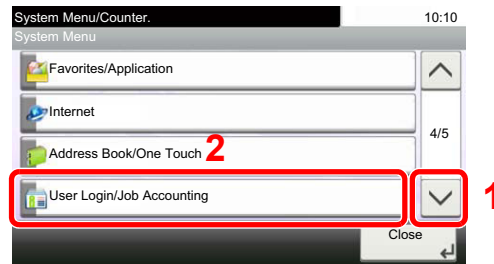

#### NOTE

If the login user name entry screen appears during operations, enter a login user name and password, and press [Login].

The factory default login user name and login password are set as shown below.

Model Name	Login User Name	Login Password
ECOSYS M3040idn/ ECOSYS M3540idn	4000	4000
ECOSYS M3550idn	5000	5000
ECOSYS M3560idn	6000	6000

- 3 Press [Job Accounting Settings], [∨] and then [Accounting List].

### 2 Delete an account.

- 1 Select the account name you wish to delete and press [🗑️].
- 2 Press [Yes] in the deletion confirmation screen.

The account is deleted.

## Job Accounting for Printing

The number of jobs to be printed from the computer can be managed by Job Accounting.

### Setting Printer Driver

To manage the number of jobs to be printed from the PC on the network, you need configure the following settings by using the printer driver on the PC.

#### 1 Display the screen.

- 1 Click **[Start]** button on the Windows, and then click **[Devices and Printers]**.

#### NOTE

In Windows 8, select **[Settings]** in charms on Desktop, and select **[Control Panel]**, and then **[Devices and Printers]**.

- 2 Right-click the printer driver icon of the machine, and click the **[Printer properties]** menu of the printer driver.
- 3 Click **[Administrator]** on the **[Device Settings]** tab.

#### 2 Configure the settings.

- 1 Select **[Job accounting]** on the **[Job Accounting]** tab.

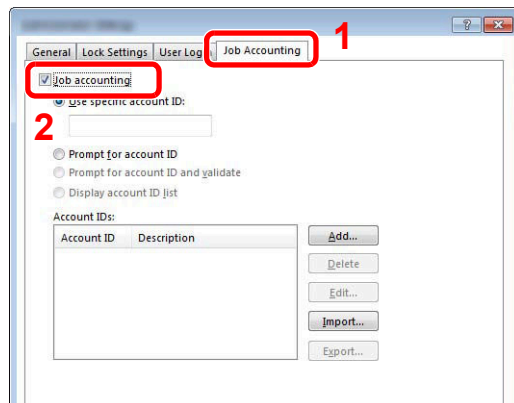

- 2 Set the Account ID.

**[Use specific account ID]:** Enter the Account ID. Printing will be performed using the entered Account ID.

**[Prompt for account ID]:** A screen for entering the Account ID will be displayed when attempting a printing. The Account ID must be entered each time a printing is attempted.

**[Prompt for account ID and validate]:** A screen for entering the Account ID will be displayed when attempting a printing. The Account ID stored in the Account ID list needs to be entered. The Account ID must be entered each time a printing is attempted.

**[Display account ID list]:** The Account ID list is displayed when printing. The Account ID to be used needs to be selected from the list.

- 3 Click **[OK]**.

#### NOTE

For other settings of job accounting, refer to **Printer Driver User Guide**.

## Job Accounting for Scan Using TWAIN

The number of jobs scanned by using TWAIN can be managed by Job Accounting.

### Setting TWAIN Driver

To manage the number of jobs scanned by using TWAIN, you need to configure the following settings by using the TWAIN Driver on the computer.

#### 1 Display the screen.

- 1 Select **[Start]** button on the Windows, **[All Programs]**, **[Kyocera]** and then **[TWAIN Driver Setting]**. TWAIN Driver screen appears.

#### NOTE

In Windows 8, select **[Search]** in charms, **[Apps]**, and then **[TWAIN Driver Setting]**.

- 2 Click **[Edit]**.

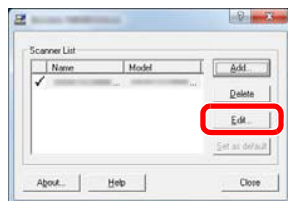

#### 2 Configure the settings.

- 1 Click **[User Authentication Settings]**.
- 2 Select the checkbox beside **[Account ID]**, and enter the account ID.

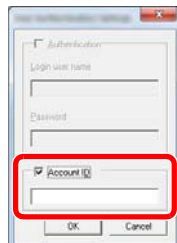

- 3 Click **[OK]**.

## Job Accounting for Scan Using WIA

The number of jobs scanned by using WIA can be managed by Job Accounting.

### Setting WIA Driver

To manage the number of jobs scanned by using WIA, you need to configure the following settings by using the WIA Driver on the computer.

#### 1 Display the screen.

- 1 Click **[Start]** button on the Windows and enter **[Scanner]** in **[Program and File Search]**. Click **[View scanners and cameras]** in the search list then the Scanners and Cameras screen appears.

#### NOTE

In Windows 8, click **[Search]** in charms, and then **[Settings]**, and enter "Scanner" in the search box. Click **[View scanners and cameras]** in the search list then the Scanners and Cameras screen appears.

- 2 Select the same name as this machine from WIA Drivers, and press **[Properties]**.

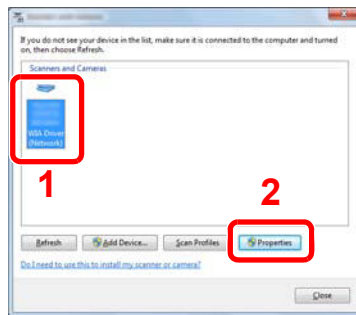

#### 2 Configure WIA Driver.

- 1 Select the checkbox beside **[Account ID]** on the **[Settings]** tab, and enter the Account ID.

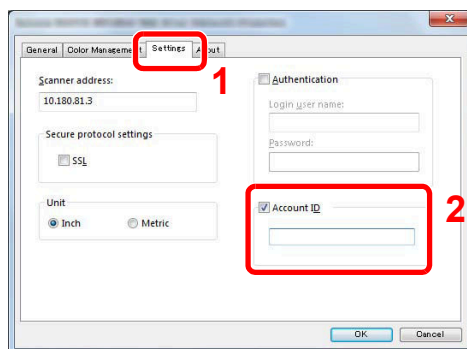

- 2 Click **[OK]**.

# Job Accounting for the FAX Transmitted from a Computer

The number of FAX jobs transmitted from the computer can be managed by Job Accounting.



## NOTE

FAX functions are available only on products with the fax function installed.

## Setting FAX Driver

To manage the number of FAX jobs transmitted from the computer, you need to configure the following settings by using the FAX Driver on the computer.

### 1 Display the screen.

- 1 Click [**Start**] button on the Windows, and then click [**Devices and Printers**].



## NOTE

In Windows 8, select [**Settings**] in charms on Desktop, and select [**Control Panel**], and then [**Devices and Printers**].

- 2 Right click the name of the machine to be used as the FAX Driver and select [**Printing preferences**] from the resulting pull-down menu.
- 3 Click [**FAX TX Setting**] in the [**Printing Preferences**] window.

### 2 Configure the settings.

- 1 Select [**Job Accounting**] on the [**Authentication**] tab.

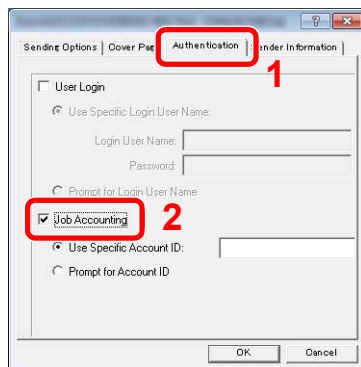

- 2 Set the Job Accounting.

[**Use Specific Account ID**]: Enter the Account ID. Transmission will be performed using the entered Account ID.

[**Prompt for Account ID**]: A screen for entering the Account ID will be displayed when attempting a transmission. The Account ID must be entered each time a transmission is attempted.

- 3 Click [**OK**].

# Configuring Job Accounting

## Default Setting

Set the defaults for job accounting. To configure the settings, select the item in Default Setting and press the setting item.

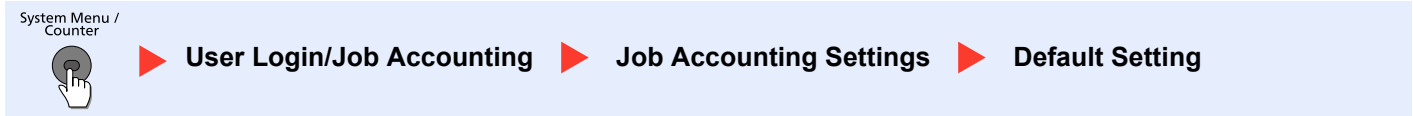

For details on each function, see the table below.

Item	Description																		
<b>Apply Limit</b>	<p>This specifies how the machine behaves when the counter has reached the limit of restriction. The table below describes the action taken.</p> <p><b>Value</b></p> <p><b>Immediately: Job stops when the counter reaches its limit.</b></p> <p><b>Subsequently: Printing/scanning of the job continues but the subsequent job will be rejected.</b></p> <p><b>Alert Only: Job continues while displaying an alert message.</b></p>																		
<b>Copy/Print Count</b>	<p>You can select how the copying and printing page counts are shown - either the total of both or each of copying and printing individually (Split). The selection may influence restriction on the count and count method. For details, refer to <a href="#">Restricting the Use of the Machine (page 9-37)</a> and <a href="#">Print Accounting Report (page 9-47)</a>.</p> <p><b>Value: Total, Individual</b></p>																		
<b>Counter Limit</b>	<p>When you add a new account, you can change the default restrictions on the number of sheets used. You can set any number from 1 to 9,999,999.</p> <p>The items that can be set differ depending on whether [Split] or [Individual] is selected for [Copy/Print Count].</p> <table border="1"> <thead> <tr> <th colspan="2">[Individual] selected for Copy/Printer Count</th> </tr> </thead> <tbody> <tr> <td><b>Copy (Total)</b></td> <td>Sets the default restriction on the number of sheets used for copying.</td> </tr> <tr> <td><b>Printer (Total)</b></td> <td>Sets the default restriction on the number of sheets used for printing.</td> </tr> <tr> <td><b>Scan (Others)</b></td> <td>Sets the default restriction on the number of sheets used for scanning (excludes copying).</td> </tr> <tr> <td><b>FAX Transmission <sup>*1</sup></b></td> <td>Sets the default restriction on the number of sheets used for sending faxes.</td> </tr> <tr> <th colspan="2">[Total] selected for Copy/Printer Count</th> </tr> <tr> <td><b>Print (Total)</b></td> <td>Sets the default restriction on the total number of sheets used for copying and printing.</td> </tr> <tr> <td><b>Scan (Others)</b></td> <td>Sets the default restriction on the number of sheets used for scanning (excludes copying).</td> </tr> <tr> <td><b>FAX Transmission <sup>*1</sup></b></td> <td>Sets the default restriction on the number of sheets used for sending faxes.</td> </tr> </tbody> </table>	[Individual] selected for Copy/Printer Count		<b>Copy (Total)</b>	Sets the default restriction on the number of sheets used for copying.	<b>Printer (Total)</b>	Sets the default restriction on the number of sheets used for printing.	<b>Scan (Others)</b>	Sets the default restriction on the number of sheets used for scanning (excludes copying).	<b>FAX Transmission <sup>*1</sup></b>	Sets the default restriction on the number of sheets used for sending faxes.	[Total] selected for Copy/Printer Count		<b>Print (Total)</b>	Sets the default restriction on the total number of sheets used for copying and printing.	<b>Scan (Others)</b>	Sets the default restriction on the number of sheets used for scanning (excludes copying).	<b>FAX Transmission <sup>*1</sup></b>	Sets the default restriction on the number of sheets used for sending faxes.
[Individual] selected for Copy/Printer Count																			
<b>Copy (Total)</b>	Sets the default restriction on the number of sheets used for copying.																		
<b>Printer (Total)</b>	Sets the default restriction on the number of sheets used for printing.																		
<b>Scan (Others)</b>	Sets the default restriction on the number of sheets used for scanning (excludes copying).																		
<b>FAX Transmission <sup>*1</sup></b>	Sets the default restriction on the number of sheets used for sending faxes.																		
[Total] selected for Copy/Printer Count																			
<b>Print (Total)</b>	Sets the default restriction on the total number of sheets used for copying and printing.																		
<b>Scan (Others)</b>	Sets the default restriction on the number of sheets used for scanning (excludes copying).																		
<b>FAX Transmission <sup>*1</sup></b>	Sets the default restriction on the number of sheets used for sending faxes.																		

\*1 Only on products with the fax function installed.

## Counting the Number of Pages Printed

This counts the number of pages printed. Counts are classified into Total Job Accounting and Each Job Accounting. A new count can also be started after resetting the count data which was stored for a certain period of time.

System Menu / Counter



▶ User Login/Job Accounting ▶ Job Accounting Settings ▶

**Total Accounting**  
**Each Job Account**

### Total Accounting

This counts the number of pages for all accounts and resets the counts for those accounts together at the same time.

### Each Job Account

This counts the number of pages for each account and resets the counts by account. When checking Each Job Accounting, select the account for which you want to check the count.

Types of the counts are as follows.

Item	Descriptions
<b>Printed Pages</b>	Displays the number of pages copied and printed, and the total number of pages used. You can also use [FAX] <sup>*1</sup> , [by Duplex] and [by Combine] to check the number of pages used.
<b>Copy (Total)</b>	Displays the number of pages copied.
<b>Printer (Total)</b>	Displays the number of pages printed.
<b>Copy/Print. (Total)</b>	Displays the total number of pages used for copying and printing.
<b>FAX<sup>*1</sup></b>	Displays the number of pages received.
<b>Total</b>	Displays the total number of pages used.
<b>by Duplex</b>	Displays the number of pages printed in [1-sided] mode, [2-sided] mode, and the total pages in both modes.
<b>by Combine</b>	Displays the number of pages printed in [None] (no Combine) mode, [2 in 1] mode, [4 in 1] mode, and the total pages in both modes.
<b>Scanned Pages</b>	Displays the number of pages scanned for copying, faxing and other functions, as well as the total number of pages scanned.
<b>FAX TX Pages<sup>*1</sup></b>	Displays the number of pages faxed.
<b>FAX TX Time<sup>*1</sup></b>	Displays the total duration of FAX transmissions.
<b>Counter Reset</b>	Resets the counter. Press [Yes] in the confirmation screen.

\*1 Only on products with the fax function installed.



## Print Accounting Report

The total pages counted of all relevant accounts can be printed as an accounting report.

Reports have different formats depending on how the count of copiers and printers is administered.

### When "Individual" is selected for Managing the Copy/Printer Count

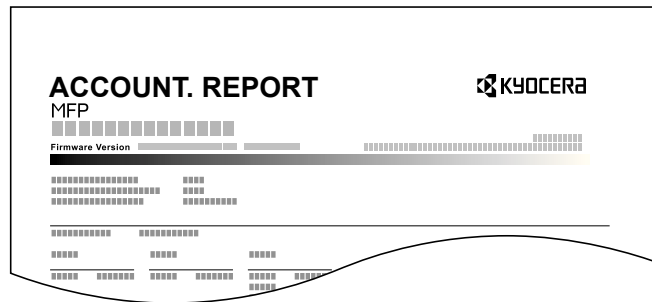

Use the procedure below to print a job accounting report.

#### 1 Prepare paper.

Check that A4 or Letter paper is loaded in the cassette.

#### 2 Display the screen.

- 1 Press the [System Menu/Counter] key.

System Menu /  
Counter



- 2 Press [∨] and then [User Login/Job Accounting].

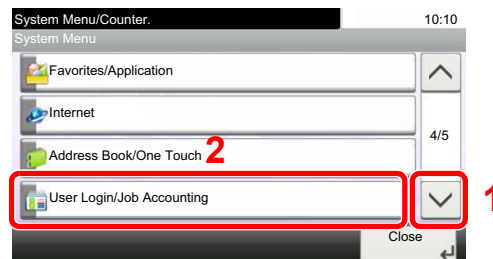

#### NOTE

If the login user name entry screen appears during operations, enter a login user name and password, and press [Login].

The factory default login user name and login password are set as shown below.

Model Name	Login User Name	Login Password
ECOSYS M3040idn/ ECOSYS M3540idn	4000	4000
ECOSYS M3550idn	5000	5000
ECOSYS M3560idn	6000	6000

### **3 Print the report.**

- 1** Press [Print Accounting Report].
- 2** Press [Yes] on the screen to confirm the printing.  
Accounting report is printed.

# Using Job Accounting

This section explains procedures while setting job accounting.

## Login/Logout

If job accounting is enabled, an account ID entry screen appears each time you use this machine.

Use the procedure below to login and logout.

### Login

- 1 In the screen below, enter the account ID using the numeric keys and press [Login].

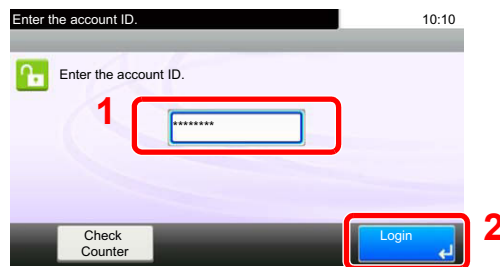

#### NOTE

- If you entered a wrong character, press the [Clear] key and enter the account ID again.
- If the entered account ID does not match the registered ID, a warning beep will sound and login will fail. Enter the correct account ID.
- By pressing [Check Counter], you can refer to the number of pages printed and the number of pages scanned.

#### When the screen to enter the login user name and password appears

If user login administration is enabled, the screen to enter the login user name and password appears. Enter a login user name and password to login. (Refer to [Adding a User \(Local User List\) on page 9-5.](#)) If the user has already registered the account information, the account ID entry would be skipped. (Refer to [Adding a User \(Local User List\) on page 9-5.](#))

- 2 Proceed to complete the rest of the steps.

### Logout

When the operations are complete, press the [Authentication/Logout] key to return to the account ID entry screen.

Authentication/  
Logout



## Job Accounting on a PC

If the following account ID entry screen appears on your computer, enter the assigned Account ID and then click [OK].

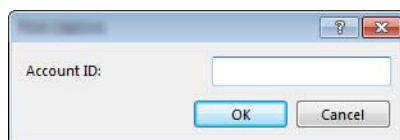

# Unknown ID Job

This specifies the behavior for handling the jobs sent with unknown or unsend login user names or User ID. If the User Login is set to invalid and Job Accounting is set to valid, follow the procedure when the Account ID is unknown.

The setting items are as follows.

Item	Descriptions
Permit	The job is permitted to be printed.
Reject	The job is rejected (not printed).

## 1 Display the screen.

- 1 Press the [System Menu/Counter] key.

System Menu /  
Counter



- 2 Press [∨] and then [User Login/Job Accounting].

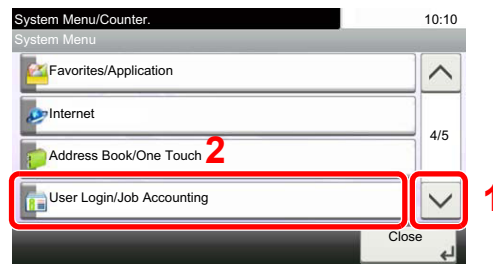

### NOTE

If the login user name entry screen appears during operations, enter a login user name and password, and press [Login].

The factory default login user name and login password are set as shown below.

Model Name	Login User Name	Login Password
ECOSYS M3040idn/ ECOSYS M3540idn	4000	4000
ECOSYS M3550idn	5000	5000
ECOSYS M3560idn	6000	6000

- 3 Press [Unknown ID Job].

## 2 Configure the settings.

Press [Permit] or [Reject].

# 10 Troubleshooting

This chapter explains the following topics:

Regular Maintenance .....	10-2
Cleaning .....	10-2
Toner Container Replacement .....	10-5
Waste Toner Box Replacement .....	10-8
Troubleshooting .....	10-10
Solving Malfunctions .....	10-10
Responding to Messages .....	10-15
Adjustment/Maintenance .....	10-25
Clearing Paper Jams .....	10-26

# Regular Maintenance

## Cleaning

Clean the machine regularly to ensure optimum printing quality.



### CAUTION

For safety, always unplug the power cord before cleaning the machine.

### Glass Platen

Wipe the inside of the document processor and the glass platen with a soft cloth dampened with alcohol or mild detergent.



### IMPORTANT

Do not use thinner or other organic solvents.

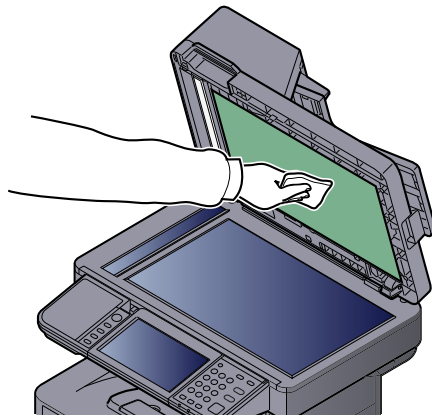

### Slit Glass

When using the document processor, clean the slit glass surface and the reading guide with the dry cloth.



### IMPORTANT

Do not use water, soap or solvents for cleaning.



### NOTE

Dirt on the slit glass or the reading guide may cause black streaks to appear in the output.

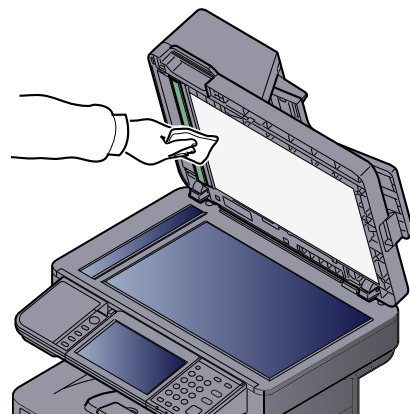
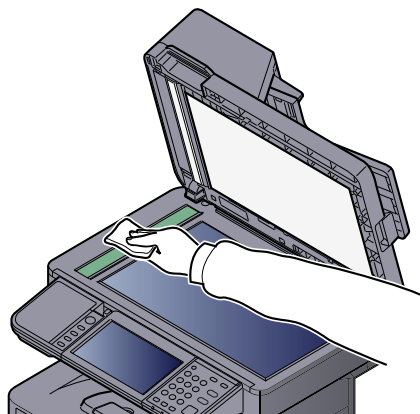

## Registration Roller

1

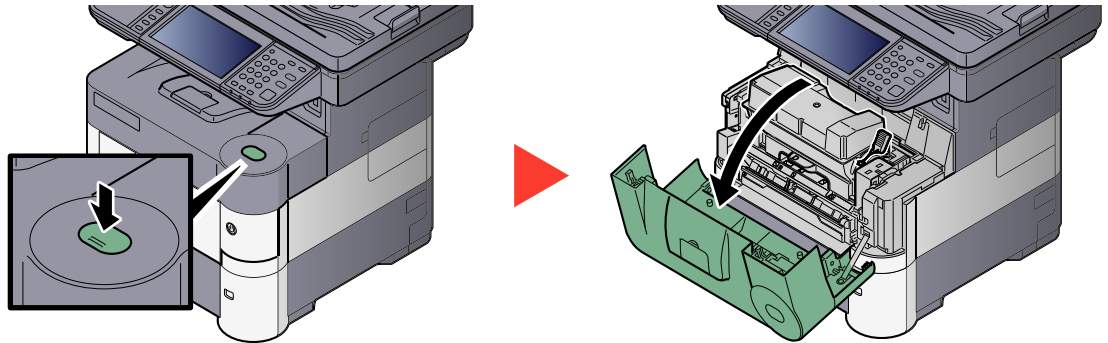

2

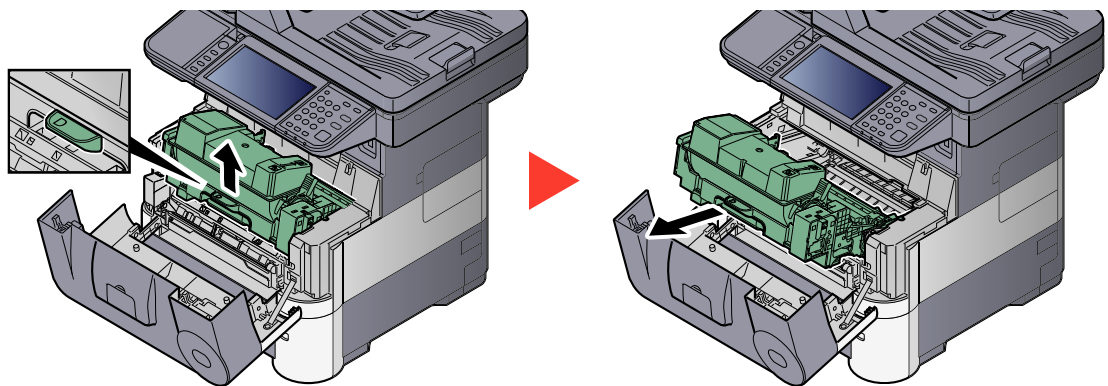

3

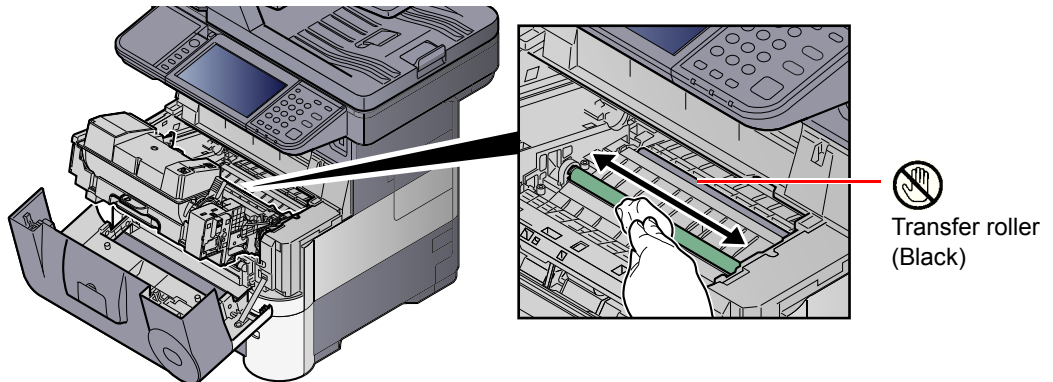

✔ **IMPORTANT**

Be careful not to touch the black transfer roller and brown transfer belt during cleaning as this may adversely affect print quality.

4

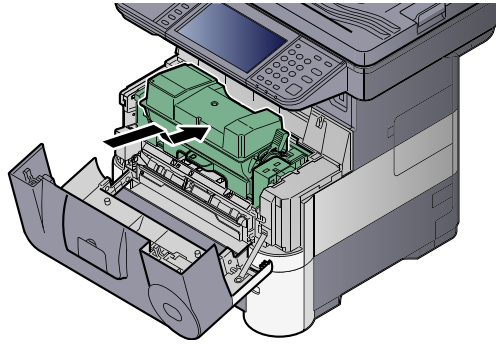

5

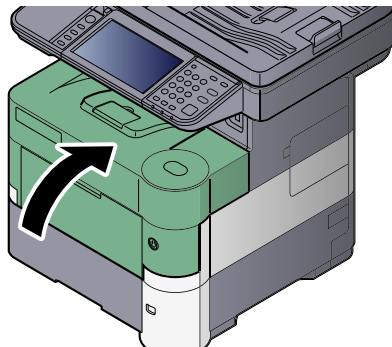

### Vents

Use a lint free cloth to clean dust and dirt away from the vents.

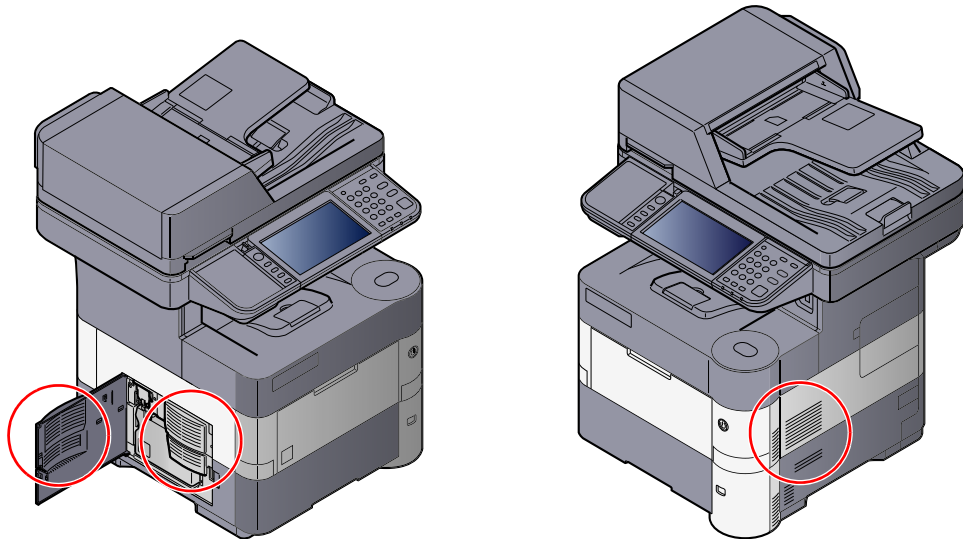



## Toner Container Replacement

When toner runs low, "Toner is low. (Replace when empty.)" appears in the touch panel. Make sure you have a new toner container available for replacement.

When the touch panel displays "Toner is empty.", replace the toner.

### NOTE

- For the toner container, always use a genuine toner container. Using a toner container that is not genuine may cause image defects and product failure.
- The memory chip in the toner container of this product stores information necessary for improving customer convenience, operation of the recycling system for used toner containers, and planning and development of new products. The stored information does not include information that makes it possible to identify individuals, and is only used anonymously for the above purposes.

### CAUTION

Do not attempt to incinerate parts which contain toner. Dangerous sparks may cause burns.

1

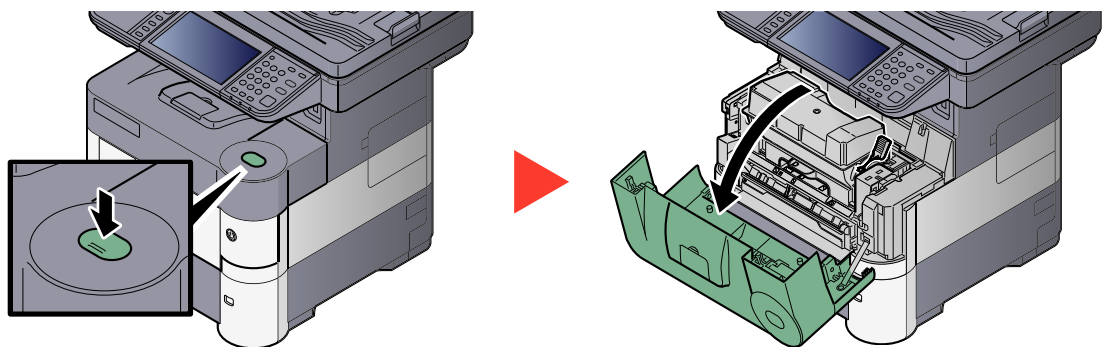

2

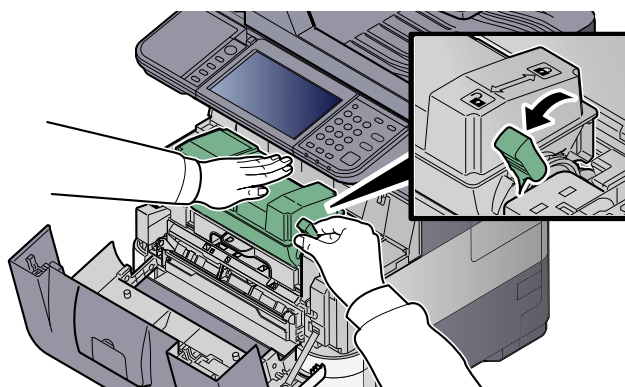

3

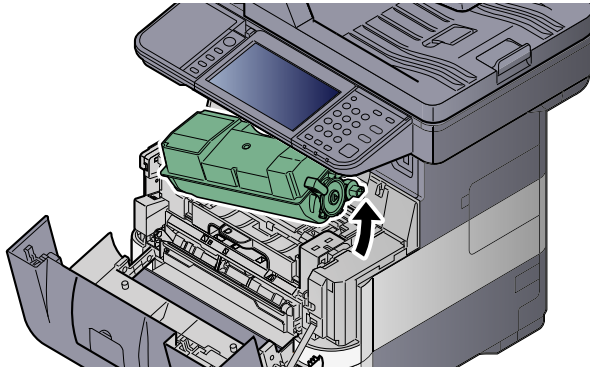

**NOTE**

When removing the toner container from the machine, lift up the right hand side first.

4

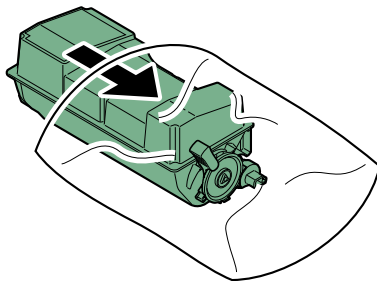

5

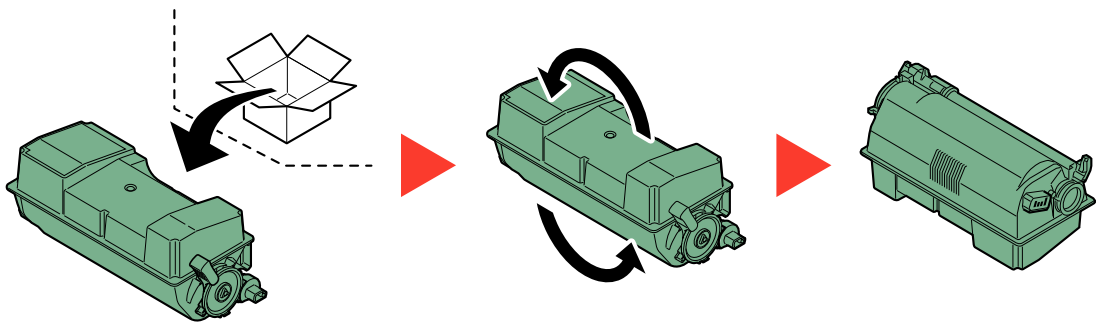

**IMPORTANT**

Do not touch the points shown below.

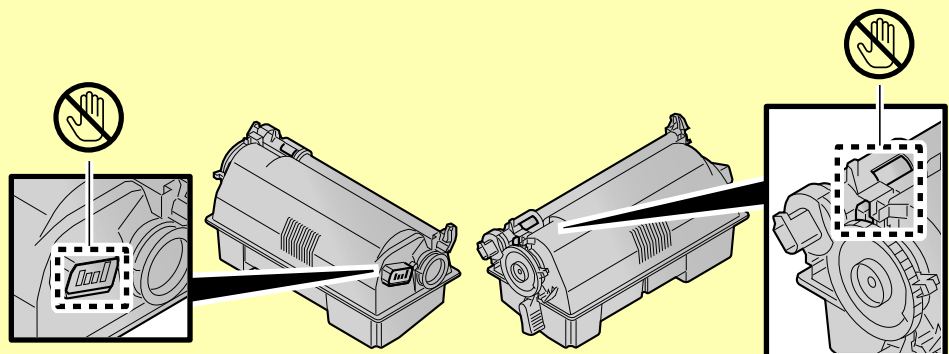

6

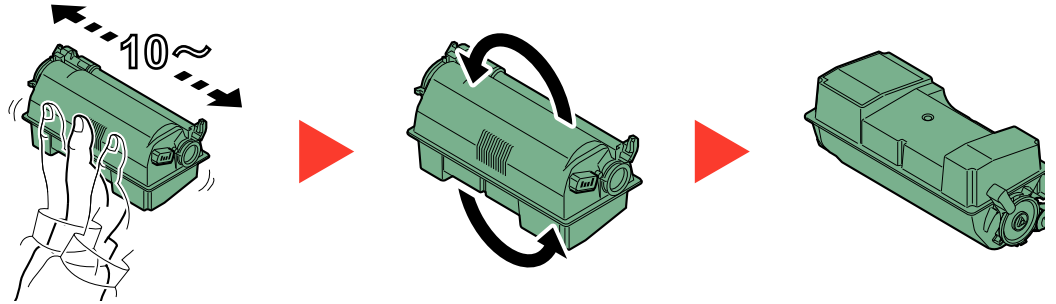

7

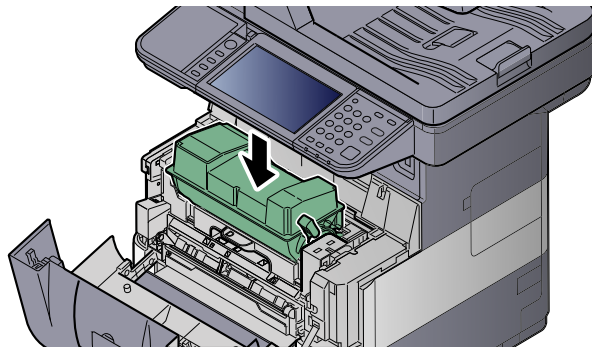

8

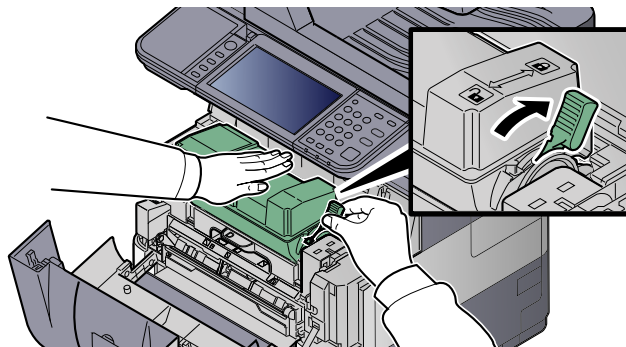

9

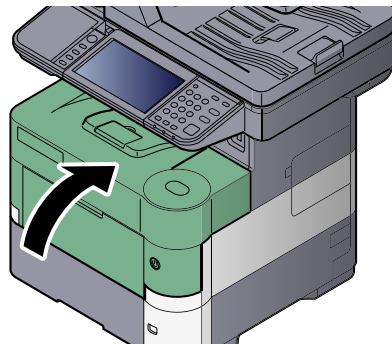

 **NOTE**

- If the front cover does not close, check that the new toner container is installed correctly (in step 7).
- Return the exhausted toner container and waste toner box to your dealer or service representative. The collected toner container and waste toner box will be recycled or disposed in accordance with the relevant regulations.

## Waste Toner Box Replacement

When the touch panel shows "Waste toner box is full.", immediately replace the waste toner box.

### CAUTION

Do not attempt to incinerate parts which contain toner. Dangerous sparks may cause burns.

1

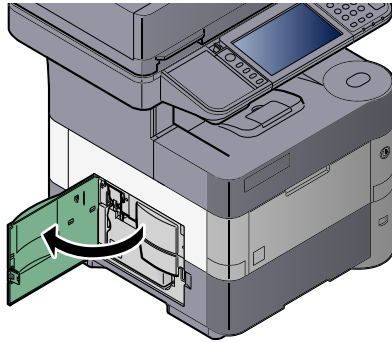

2

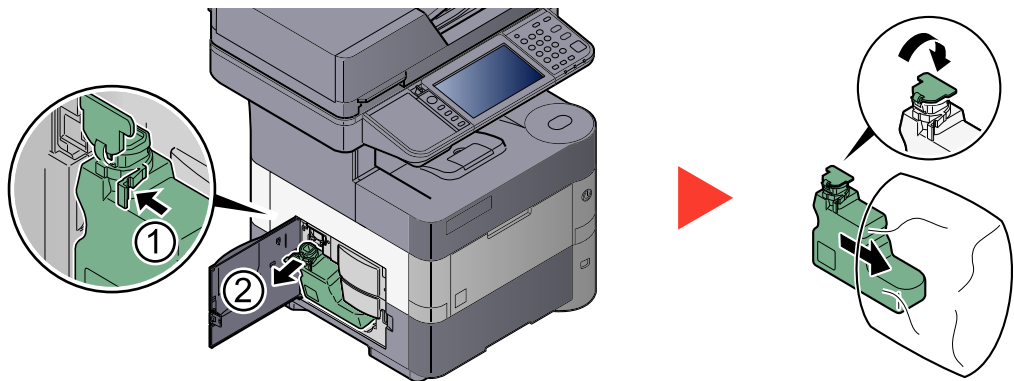

3

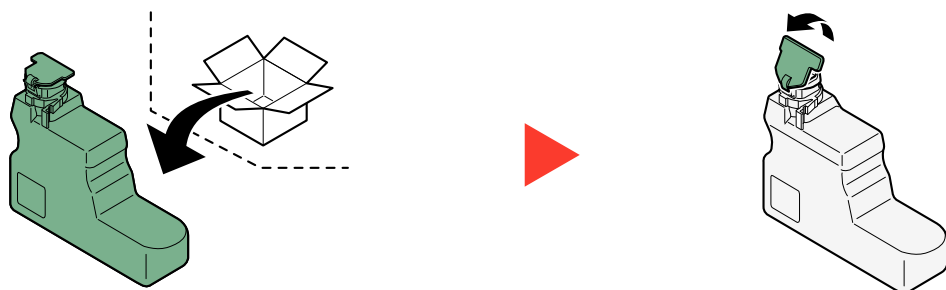

4

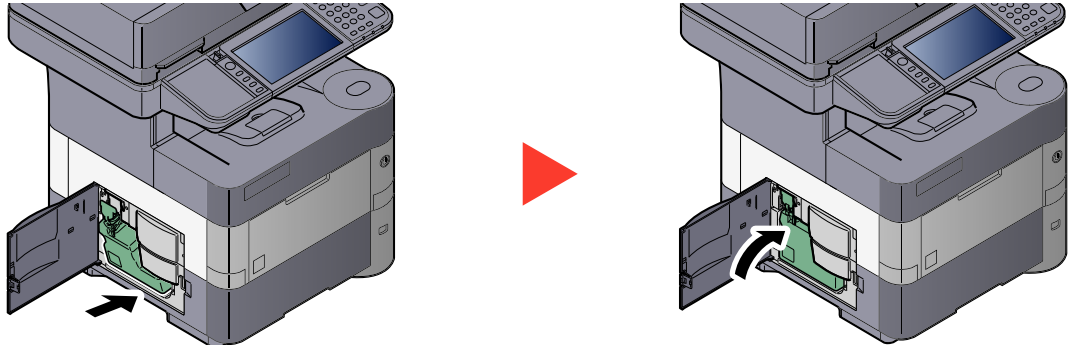

5

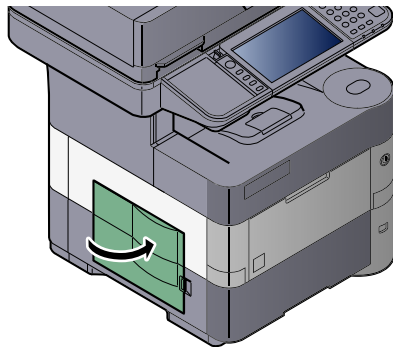

**NOTE**

Return the exhausted toner container and waste toner box to your dealer or service representative. The collected toner container and waste toner box will be recycled or disposed in accordance with the relevant regulations.

# Troubleshooting

## Solving Malfunctions

The table below provides general guidelines for problem solving.



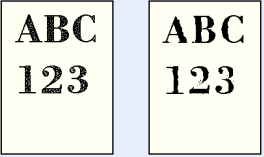
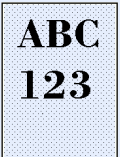

If a problem occurs with your machine, look into the checkpoints and perform procedures indicated on the following pages. If the problem persists, contact your Service Representative.

 **NOTE**



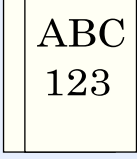
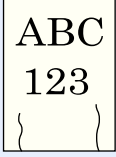

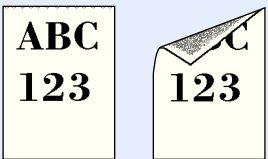
When contacting us, the serial number will be necessary. To check the serial number, refer to [Display for Device Information on page 3-8](#).

Symptom	Checkpoints	Corrective Actions	Reference Page
An application does not start.	Is the Auto Panel Reset time short?	Set the Auto Panel Reset time to 30 seconds or more.	<a href="#">page 8-37</a>
The screen does not respond when the main power switch is turned on.	Check the power cord.	Connect both ends of the power cord securely.	<a href="#">page 2-7</a>
Pressing the [Start] key does not produce copies.	Is there a message on the screen?	Determine the appropriate response to the message and respond accordingly.	<a href="#">page 10-15</a>
	Is the machine in Sleep mode?	Press any key on the operation panel to recover the machine from Sleep mode.	<a href="#">page 2-15</a>
Blank sheets are ejected. 	Are the originals loaded correctly?	When placing originals on the platen, place them face-down and align them with the original size indicator plates.	<a href="#">page 5-2</a>
	—	When placing originals in the document processor, place them face-up.	<a href="#">page 5-3</a>
	—	Check that the settings of the application software.	—
Printouts are totally too light. 	Is the paper damp?	Replace the paper with new paper.	<a href="#">page 3-12</a>
	Have you changed the density?	Select appropriate density level.	<a href="#">page 6-11</a> <a href="#">page 8-40</a>
	Is the toner distributed evenly within the toner container?	Shake the toner container from side to side several times.	<a href="#">page 10-5</a>
	Is EcoPrint mode enabled?	Disable [EcoPrint] mode.	<a href="#">page 6-12</a>
	—	Run [Drum Refresh].	<a href="#">page 10-25</a>
	—	Make sure the paper type setting is correct for the paper being used.	<a href="#">page 8-14</a>
Printouts are too dark even though the background of the scanned original is white. 	Have you changed the density?	Select appropriate density level.	<a href="#">page 6-11</a> <a href="#">page 8-40</a>

Symptom	Checkpoints	Corrective Actions	Reference Page
<p>Copies have a moire pattern (dots grouped together in patterns and not aligned uniformly).</p> 	Is the original a printed photograph?	Set the original image to [Photo].	<a href="#">page 6-11</a>
<p>Texts are not clearly printed.</p> 	Did you choose appropriate image quality for the original?	Select appropriate image quality.	<a href="#">page 6-11</a>
<p>Black or color dots appear on the white background when white original is scanned.</p> 	Is the inside of the document processor or the glass platen dirty?	Clean the inside of the document processor or the glass platen.	<a href="#">page 10-2</a>
<p>Printouts have vertical lines.</p> 	Is the slit glass dirty?	Clean the slit glass.	<a href="#">page 10-2</a>
<p>Printouts are fuzzy.</p> 	Is the machine being used in conditions of very humid, or humidity or temperature rapidly changes?	Use in an environment that has suitable humidity.	—
	—	Run [Drum Refresh].	<a href="#">page 10-25</a>
<p>Images are skewed.</p> 	Are the originals loaded correctly?	When placing originals on the platen, align them with the original size indicator plates.	<a href="#">page 5-2</a>
		When placing originals in the document processor, align the original width guides securely before placing the originals.	<a href="#">page 5-3</a>
	Is the paper loaded correctly?	Check the position of the paper width guides.	<a href="#">page 3-14</a> <a href="#">page 3-18</a>
<p>Paper often jams.</p>	Is the paper loaded correctly?	Load the paper correctly.	<a href="#">page 3-14</a> <a href="#">page 3-18</a>
	Is the paper of the supported type? Is it in good condition?	Remove the paper, turn it over, and reload it.	<a href="#">page 3-14</a>
	Is the paper curled, folded or wrinkled?	Replace the paper with new paper.	<a href="#">page 3-14</a>
	Are there any loose scraps or jammed paper in the machine?	Remove any jammed paper.	<a href="#">page 10-26</a>

Symptom	Checkpoints	Corrective Actions	Reference Page
<p>2 or more sheets are overlaps when ejected. (multi feed)</p> 	—	Load the paper correctly.	<a href="#">page 3-14</a> <a href="#">page 3-18</a>
<p>Printouts are wrinkled.</p> 	Is the paper loaded correctly?	Load the paper correctly.	<a href="#">page 3-14</a> <a href="#">page 3-18</a>
	Is the paper damp?	Replace the paper with new paper.	<a href="#">page 3-14</a>
<p>Printouts are curled.</p> 	Is the paper damp?	Replace the paper with new paper.	<a href="#">page 3-14</a>
<p>Cannot print.</p>	Is the machine plugged in?	Plug the power cord into an AC outlet.	—
	Is the machine powered on?	Turn on the power switch.	<a href="#">page 2-8</a>
	Are the printer cable and network cable connected?	Connect the correct printer cable and network cable securely.	<a href="#">page 2-6</a>
	Was the machine powered on before the printer cable was connected?	Power on the machine after connecting the printer cable.	—
	Is the print job paused?	Resume printing.	<a href="#">page 7-4</a>
<p>Cannot print with USB memory. USB memory not recognized.</p>	Is the USB host blocked?	Select [Unblock] in the USB host settings.	<a href="#">page 8-34</a>
	—	Check that the USB memory is securely plugged into the machine.	—
<p>Dirt on the top edge or back of the paper.</p> 	Is the interior of the machine dirty?	Clean the interior of the machine.	<a href="#">page 10-3</a>
<p>Part of the image is periodically faint or shows white lines.</p> 	—	Press the <b>[System Menu/Counter]</b> key, <b>[Adjustment/Maintenance]</b> , <b>[Service Setting]</b> , <b>[MC]</b> and decrease the adjustment value. Decrease the adjustment value 1 level at a time from the current value. If there is no improvement after the value is decreased by 1 level, decrease by 1 level again. If there is still no improvement, return the setting to the original value.	—
	—	Run <b>[Drum Refresh]</b> .	<a href="#">page 10-25</a>



Symptom	Checkpoints	Corrective Actions	Reference Page
<p>Irregular horizontal lines appear in the image.</p> 	—	<p>Press the <b>[System Menu/Counter]</b> key, <b>[Adjustment/Maintenance]</b>, <b>[Service Setting]</b>, <b>[MC]</b> and decrease the adjustment value. Decrease the adjustment value 1 level at a time from the current value. If there is no improvement after the value is decreased by 1 level, decrease by 1 level again. If there is still no improvement, return the setting to the original value.</p>	—
<p>The altitude is 1500 m or higher and irregular horizontal white lines appear in the image.</p> 	—	<p>Press the <b>[System Menu/Counter]</b> key, <b>[Adjustment/Maintenance]</b>, <b>[Service Setting]</b>, <b>[Altitude Adjustment]</b> and then select <b>[High 1]</b>. If there is still no improvement, change the value to <b>[High 2]</b>.</p>	—
<p>The altitude is 1500 m or higher and dots appear in the image.</p> 	—	<p>Press the <b>[System Menu/Counter]</b> key, <b>[Adjustment/Maintenance]</b>, <b>[Service Setting]</b>, <b>[Altitude Adjustment]</b> and then select <b>[High 1]</b>. If there is still no improvement, change the value to <b>[High 2]</b>.</p>	—
<p>Print on the back of the sheet is visible on the front.</p> 	—	<p>Set <b>[Prevent Bleed-through]</b> to <b>[On]</b>.</p>	<p><a href="#">page 6-14</a> <a href="#">page 8-16</a></p>
<p>The previous image remains and lightly printed.</p> 	—	<p>Press the <b>[System Menu/Counter]</b> key, <b>[Adjustment/Maintenance]</b>, <b>[Service Setting]</b>, <b>[MC]</b> and increase the adjustment value. Increase the adjustment value 1 level at a time from the current value. If there is no improvement after the value is increased by 1 level, increase by 1 level again. If there is still no improvement, return the setting to the original value.</p>	—

Symptom	Checkpoints	Corrective Actions	Reference Page
Cannot send via SMB.	Is the network cable connected?	Connect the correct network cable securely.	<a href="#">page 2-6</a>
	Have the network settings for the equipment been configured properly?	Configure the TCP/IP settings properly.	<a href="#">page 8-27</a>
	Have the folder sharing settings been configured properly?	Check sharing settings and access privileges under the folder properties.	—
	Has the SMB protocol been set to [On]?	Set the SMB protocol setting to [On].	<a href="#">page 5-26</a>
	Has [Host Name] been entered properly? *1	Check the name of the computer to which data is being sent.	<a href="#">page 5-26</a>
	Has [Path] been entered properly?	Check the share name for the shared folder.	<a href="#">page 5-26</a>
	Has [Login User Name] been entered properly? *1 *2	Check the domain name and login user name.	<a href="#">page 5-26</a>
	Has the same domain name been used for [Host Name] and [Login User Name]?	Delete the domain name and backslash ("¥") from [Login User Name].	<a href="#">page 5-26</a>
	Has [Login Password] been entered properly?	Check the login password.	<a href="#">page 5-26</a>
	Have exceptions for Windows Firewall been configured properly?	Configure exceptions for Windows Firewall properly.	<a href="#">page 3-31</a>
	Do the time settings for the equipment, domain server, and data destination computer differ?	Set the equipment, domain server, and data destination computer to the same time.	—
	Is the screen displaying Send error?	Refer to <a href="#">Responding to Send Error</a> .	<a href="#">page 10-23</a>
Cannot send via the e-mail.	Is the E-mail send size limit set in the SMTP server registered on the machine?	Check the limit value is entered to "E-mail Size Limit" of [E-mail] setting in Command Center RX and change the value as necessary.	<a href="#">page 2-41</a>

\*1 You can also enter a full computer name as the host name (for example, pc001.abcdnet.com).

\*2 You can also enter login user names in the following formats:  
 Domain\_name/user\_name (for example, abcdnet/james.smith)  
 User\_name@domain\_name (for example, james.smith@abcdnet)

## Responding to Messages

If the touch panel or the computer displays any of these messages, follow the corresponding procedure.



### NOTE

When contacting us, the serial number will be necessary. To check the serial number, refer to [Display for Device Information on page 3-8](#).

### A

Message	Checkpoints	Corrective Actions	Reference Page
<b>Activation error.</b>	—	Turn the power switch off and on. If the error exists, contact administrator.	—
<b>Add the following paper in cassette #.</b>	Does the selected paper size matches the paper size loaded in the specified paper source?	Press [Continue] to continue printing. Press [Cancel] to cancel the job.	—
	Is the indicated cassette out of paper?	Load paper. Press [Paper Selection] to select the other paper source. Press [Continue] to print on the paper in the currently selected paper source.	<a href="#">page 3-12</a>
<b>Add the following paper in the multi purpose tray.</b>	Does the selected paper size matches the paper size loaded in the specified paper source?	Press [Continue] to continue printing. Press [Cancel] to cancel the job.	—
	Is the indicated cassette out of paper?	Load paper. Press [Paper Selection] to select the other paper source. Press [Continue] to print on the paper in the currently selected paper source.	<a href="#">page 3-18</a>

### B

Message	Checkpoints	Corrective Actions	Reference Page
<b>Box is not found.</b>	—	The specified box cannot be found. Job is canceled. Press [End].	—
<b>Box limit exceeded.*1</b>	Is [End] displayed on the screen?	The specified box is full, and no further storage is available; Job is canceled. Press [End]. Try to perform the job again after printing or deleting data from the box.	—

\*1 When Auto Error Clear is set to [On], processing resumes automatically after a set amount of time elapses. For details on Auto Error Clear, refer to [Auto Error Clear on page 8-39](#).

C

Message	Checkpoints	Corrective Actions	Reference Page
<b>Cannot connect to Authentication Server.*1</b>	—	Set machine time to match the server's time.	<a href="#">page 2-11</a>
	—	Check the domain name.	<a href="#">page 9-2</a>
	—	Check the domain name.	<a href="#">page 9-2</a>
	—	Check the connection status with the server.	—
<b>Cannot connect to Server.</b>	—	Check the connection status with the server.	—
<b>Cannot duplex print on the following paper.*1</b>	Did you select a paper size/type that cannot be duplex printed?	Press [Paper Selection] to select the available paper. Press [Continue] to print without using Duplex function.	<a href="#">page 6-18</a>
<b>Cannot print the specified number of copies.*1</b>	—	<p>Only one copy is available. Press [Continue] to continue printing. Press [Cancel] to cancel the job.</p> <p>The machine may reproduce the same originals by arranging the following settings:</p> <ul style="list-style-type: none"> <li>Uncheck [RAM Disk] in the [Device Settings] tab of the printer's properties.</li> </ul> <p> <b>NOTE</b> If you unchecked the [RAM Disk], check the [RAM Disk] again after the printing is completed. If not, print speed may be reduced.</p>	—
<b>Cannot process this job.*1</b>	—	This job is canceled because it is restricted by User Authorization or Job Accounting. Press [End].	—
<b>Cassette is not installed.</b>	—	Cannot feed paper. Set the cassette indicated on the screen.	—
<b>Check the envelope switch.</b>	Does the envelope lever setting match the paper type?	Match the paper type and the envelope lever position.	<a href="#">page 3-20</a>
<b>Check the document processor.</b>	Is the document processor open?	Close the document processor.	—
<b>Check the toner container.</b>	—	The toner container is not installed correctly. Set it correctly.	<a href="#">page 10-5</a>

\*1 When Auto Error Clear is set to [On], processing resumes automatically after a set amount of time elapses. For details on Auto Error Clear, refer to [Auto Error Clear on page 8-39](#).

E

Message	Checkpoints	Corrective Actions	Reference Page
<b>Error occurred at cassette #.</b>	—	Remove the indicated cassette. Press [Next >] to follow the instructions.	—

**F**

Message	Checkpoints	Corrective Actions	Reference Page
<b>Failed to specify Job Accounting.*<sup>1</sup></b>	—	Failed to specify Job Accounting when processing the job externally. The job is canceled. Press [End].	—
<b>Failed to store job retention data.</b>	—	The job is canceled. Press [End]. Insufficient free space in the Job Box. Try to perform the job again after printing or deleting data from the Job Box.	—

\*1 When Auto Error Clear is set to [On], processing resumes automatically after a set amount of time elapses. For details on Auto Error Clear, refer to [Auto Error Clear on page 8-39](#).

**I**

Message	Checkpoints	Corrective Actions	Reference Page
<b>Incorrect account ID.*<sup>1</sup></b>	—	The account ID was incorrect when processing the job externally. The job is canceled. Press [End].	—
<b>Incorrect box password.</b>	—	The box password was incorrect when processing the job externally. The job is canceled. Press [End].	—
<b>Incorrect Login User Name or Password.*<sup>1</sup></b>	—	The login user name or password was incorrect when processing the job externally. The job is canceled. Press [End].	—
<b>Inner tray is full of paper.</b>	—	Remove paper from the inner tray. Press [Continue] to resume printing. Press [Cancel] to cancel the job.	—

\*1 When Auto Error Clear is set to [On], processing resumes automatically after a set amount of time elapses. For details on Auto Error Clear, refer to [Auto Error Clear on page 8-39](#).

**J**

Message	Checkpoints	Corrective Actions	Reference Page
<b>Job Accounting restriction exceeded.</b>	Is the acceptable printing count restricted by Job Accounting exceeded?	The printing count exceeded the acceptable count restricted by Job Accounting. Cannot print any more. This job is canceled. Press [End].	—

**K**

Message	Checkpoints	Corrective Actions	Reference Page
<b>KPDL error.*<sup>1</sup></b>	—	PostScript error has occurred. The job is canceled. Press [End].	—

\*1 When Auto Error Clear is set to [On], processing resumes automatically after a set amount of time elapses. For details on Auto Error Clear, refer to [Auto Error Clear on page 8-39](#).

**M**

Message	Checkpoints	Corrective Actions	Reference Page
<b>Machine failure.</b>	—	Internal error has occurred. Make a note of the error code displayed on the screen, and contact your Service Representative.	—
<b>Maximum number of scanned pages.</b>	Is the acceptable scanning count exceeded?	Only one copy of the scanned pages is available. Press [Continue] to print, send or store the scanned pages. Press [Cancel] to cancel printing, sending or storing.	—
<b>Memory card error.</b>	—	An error has occurred on the memory card. Job is canceled. Press [End].  04: Insufficient space on the memory card to complete this operation. Move data or delete unneeded data.	—
<b>Memory is full.*1</b>	—	The process cannot be performed due to insufficient memory. The job is canceled. Press [End].  The machine may reproduce the same originals by arranging the following setting: <ul style="list-style-type: none"> <li>Decrease [Image Quality] of [File Format].</li> </ul>	—
	—	Unable to continue the job as the memory is used up. Press [Continue] to print the scanned pages. The print job cannot be processed completely. Press [Cancel] to cancel the job.  The machine may reproduce the same originals by arranging the following settings: <ul style="list-style-type: none"> <li>Select [On] of RAM Disk Setting in System Menu, and then decrease the RAM disk size.</li> <li>Select [Printer Priority] of Optional Memory in System Menu.</li> </ul> <p> <b>NOTE</b> Before changing the RAM Disk Setting or Optional Memory setting, contact your administrator.</p>	—

\*1 When Auto Error Clear is set to [On], processing resumes automatically after a set amount of time elapses. For details on Auto Error Clear, refer to [Auto Error Clear on page 8-39](#).

**P**

Message	Checkpoints	Corrective Actions	Reference Page
<b>Paper jam.</b>	—	If a paper jam occurs, the machine will stop and the location of the jam will be indicated on the screen. Leave the machine on and follow the instruction to remove the jammed paper.	<a href="#">page 10-26</a>
<b>Performing Drum Refresh...</b>	—	The machine is under the adjustment to maintain its quality. Please wait.	—
<b>Print overrun.</b>	—	Warning. Low printer memory. The job was paused. Re-starting the job. Press [Continue].	—

**R**

Message	Checkpoints	Corrective Actions	Reference Page
<b>RAM disk error.</b>	—	An error has occurred on the RAM disk. Job is canceled. Press [End]. The possible error codes and their descriptions are as follows. 04: Insufficient space on the RAM disk. If the optional RAM dis is installed, increase the RAM disk size by changing RAM Disk Setting in System Menu.  <b>NOTE</b> The range of RAM disk size can be increased by selecting [Printer Priority] in Optional Memory.	—
<b>Removable memory error.</b>	Is writing to a removable memory prohibited?	An error occurred in the removable memory. The job stopped. Press [End]. The possible error codes and their descriptions are as follows. 01: Connect a removable memory that can be written to.	—
	—	An error occurred in the removable memory. The job stopped. Press [End]. The possible error codes and their descriptions are as follows. 01: The amount of data that can be saved at once has been exceeded. Turn the power OFF/ON. If the error still occurs, the removable memory is not compatible with the machine. Use the removable memory formatted by this machine. If the removable memory cannot be formatted, it is damaged. Connect a compatible removable memory.	—

Message	Checkpoints	Corrective Actions	Reference Page
<b>Removable Memory is full.*1</b>	—	Job is canceled. Press [End]. Insufficient free space in the removable memory. Delete unnecessary files.	—
<b>Remove originals in the document processor.</b>	Are there any originals left in the document processor?	Remove originals from the document processor.	—
<b>Replace all originals and press [Continue].</b>	—	Remove originals from the document processor, put them back in their original order, and place them again. Press [Continue] to resume printing. Press [Cancel] to cancel the job.	—
<b>Replace MK.</b>	—	Replacement of the parts in the maintenance kit is necessary at every 300,000 pages (ECOSYS M3040idn/ECOSYS M3540idn) or 500,000 pages (ECOSYS M3550idn/ECOSYS M3560idn) of printing and requires professional servicing. Contact your Service Representative.	—
<b>Running security function...</b>	—	Running security function. Please wait.	—

\*1 When Auto Error Clear is set to [On], processing resumes automatically after a set amount of time elapses. For details on Auto Error Clear, refer to [Auto Error Clear on page 8-39](#).



S

Message	Checkpoints	Corrective Actions	Reference Page
<b>Scanner memory is full.*1</b>	—	<p>Scanning cannot be performed due to insufficient memory of scanner. Only one copy of the scanned pages is available. Press [Continue] to print, send or store the scanned pages. Press [Cancel] to cancel the printing job.</p> <p>The machine may reproduce the same originals by arranging the following settings:</p> <ul style="list-style-type: none"> <li>Reduce the number of originals to be scanned at once.</li> </ul> <p>Furthermore, the machine may reproduce the same originals by arranging the following settings:</p> <ul style="list-style-type: none"> <li>Select [Copy Priority] of Optional Memory in System Menu.</li> </ul> <p> <b>NOTE</b> Before changing the Optional Memory setting, contact your administrator.</p>	—
<b>Send Error.*1</b>	—	<p>An error has occurred during transmission. The job is canceled. Press [End].</p> <p>Refer to <a href="#">Responding to Send Error</a> for the error code and corrective actions.</p>	<a href="#">page 10-23</a>
<b>SSD error.</b>	—	<p>An error has occurred on SSD. Job is canceled. Press [End].</p> <p>The possible error codes and their descriptions are as follows.</p> <p>01: The amount of data that can be saved at once has been exceeded. Turn the power OFF/ON. If the error still occurs, divide the file into smaller files. If the error occurs after the file is divided, the specified file may be damaged. Delete the file.</p> <p>04: Insufficient space on SSD to complete this operation. Move data or delete unneeded data.</p> <p>05: The specified file may be deleted.</p>	—
<b>System error.</b>	—	<p>System error has occurred. Follow the instructions on the screen.</p>	—

\*1 When Auto Error Clear is set to [On], processing resumes automatically after a set amount of time elapses. For details on Auto Error Clear, refer to [Auto Error Clear on page 8-39](#).

T

Message	Checkpoints	Corrective Actions	Reference Page
<b>The cover is open.</b>	Is the top cover of the document processor open?	Close the document processor cover.	—
	Is there any cover which is open?	Close the cover indicated on the screen.	
<b>The manufacturer assumes no responsibility for damage caused by a non-genuine toner.</b>	Is the installed toner container our own brand?	We will not be liable for any damage caused by the use of third party supplies in this machine. If you want to continue, press [Next].	—
<b>The slit glass requires cleaning.</b>	—	Clean the slit glass using the cleaning cloth supplied with a soft cloth.	<a href="#">page 10-2</a>
<b>This memory is not formatted.</b>	Is the removable memory formatted by this machine?	Perform [Format] on this machine.	<a href="#">page 7-13</a>
<b>This user account is locked out.</b>	—	Contact administrator. Job is canceled. Press [End].	—
<b>Toner is empty.</b>	—	Replace the toner container.	<a href="#">page 10-5</a>
<b>Toner is low. (Replace when empty.)</b>	—	It is almost time to replace the toner container. Obtain a new toner container.	—

U

Message	Checkpoints	Corrective Actions	Reference Page
<b>Unknown Toner Installed. PC</b>	Does the installed toner container's regional specification match the machine's?	Install the specified container.	—



W

Message	Checkpoints	Corrective Actions	Reference Page
<b>Warning low memory.</b>	—	Cannot start the job. Try again later.	—
<b>Waste toner box is full.</b>	Is the waste toner box full?	Replace the waste toner box.	<a href="#">page 10-8</a>
<b>Waste toner box is not installed.</b>	—	The waste toner box is not installed correctly. Set it correctly.	<a href="#">page 10-8</a>

Y

Message	Checkpoints	Corrective Actions	Reference Page
<b>You cannot use this box.</b>	—	You cannot use the specified box. Job is canceled. Press [End].	—

## Responding to Send Error

Error Code	Message	Corrective Actions	Reference Page
1102	Failed to send via SMB.	Check the SMB settings. <ul style="list-style-type: none"> <li>• Login user name and login password</li> </ul>  <b>NOTE</b> If the sender is a domain user, specify the domain name. <ul style="list-style-type: none"> <li>• Host name</li> <li>• Path</li> </ul>	—
	Failed to send the e-mail.	Check the following on the Command Center RX. <ul style="list-style-type: none"> <li>• SMTP login user name and login password</li> <li>• POP3 login user name and login password</li> <li>• E-mail size limit</li> </ul>	—
	Failed to send via FTP.	Check the FTP settings. <ul style="list-style-type: none"> <li>• Login user name and login password</li> </ul>  <b>NOTE</b> If the sender is a domain user, specify the domain name. <ul style="list-style-type: none"> <li>• Path</li> <li>• Folder share permissions of the recipient</li> </ul>	—
1103	Failed to send via SMB.	Check the SMB settings. <ul style="list-style-type: none"> <li>• Login user name and login password</li> </ul>  <b>NOTE</b> If the sender is a domain user, specify the domain name. <ul style="list-style-type: none"> <li>• Path</li> <li>• Folder share permissions of the recipient</li> </ul>	<a href="#">page 5-26</a>
1132	Failed to send the e-mail.	Check the following of the SMTP server. <ul style="list-style-type: none"> <li>• Is SMTP over SSL available?</li> <li>• Is the encryption available?</li> </ul>	<a href="#">page 2-34</a>
	Failed to send via FTP.	Check the following of the FTP server. <ul style="list-style-type: none"> <li>• Is FTPS available?</li> <li>• Is the encryption available?</li> </ul>	<a href="#">page 2-34</a>

Error Code	Message	Corrective Actions	Reference Page
2101	Failed to send via SMB.	Check the network and SMB settings. <ul style="list-style-type: none"> <li>• The network cable is connected.</li> <li>• The hub is not operating properly.</li> <li>• The server is not operating properly.</li> <li>• Host name and IP address</li> <li>• Port number</li> </ul>	—
	Failed to send via FTP.	Check the network and FTP settings. <ul style="list-style-type: none"> <li>• The network cable is connected.</li> <li>• The hub is not operating properly.</li> <li>• The server is not operating properly.</li> <li>• Host name and IP address</li> <li>• Port number</li> </ul>	—
	Failed to send the e-mail.	Check the network and Command Center RX. <ul style="list-style-type: none"> <li>• The network cable is connected.</li> <li>• The hub is not operating properly.</li> <li>• The server is not operating properly.</li> <li>• POP3 server name of the POP3 user</li> <li>• SMTP server name</li> </ul>	—
2102 2103	Failed to send via FTP.	Check the network. <ul style="list-style-type: none"> <li>• The network cable is connected.</li> <li>• The hub is not operating properly.</li> <li>• The server is not operating properly.</li> </ul>	—
		Check the following of the FTP server. <ul style="list-style-type: none"> <li>• Is FTP available?</li> <li>• The server is not operating properly.</li> </ul>	—
	Failed to send the e-mail.	Check the network. <ul style="list-style-type: none"> <li>• The network cable is connected.</li> <li>• The hub is not operating properly.</li> <li>• The server is not operating properly.</li> </ul>	—
2201 2202 2203 2231	Failed to send the e-mail. Failed to send via FTP. Failed to send via SMB.	Check the network. <ul style="list-style-type: none"> <li>• The network cable is connected.</li> <li>• The hub is not operating properly.</li> <li>• The server is not operating properly.</li> </ul>	—
3101	Failed to send the e-mail.	Check the authentication methods of both the sender and the recipient.	—
	Failed to send via FTP.	Check the network. <ul style="list-style-type: none"> <li>• The network cable is connected.</li> <li>• The hub is not operating properly.</li> <li>• The server is not operating properly.</li> </ul>	—

## Adjustment/Maintenance

### Drum Refresh

Remove image blur and white dots from the printout.



#### NOTE

Drum Refresh cannot be performed while printing. Execute Drum Refresh after the printing is done.

#### 1 Display the screen.

- 1 Press the [System Menu/Counter] key.

System Menu /  
Counter



- 2 Press [∨], [Adjustment/Maintenance], [∨] and then [Drum Refresh].

#### 2 Perform the drum refresh.

Press [Start] to perform Drum Refresh.

# Clearing Paper Jams

If a paper jam occurs, the touch panel will display "Paper Jam." and the machine will stop. Refer to these procedures to remove the jammed paper.

## Jam Location Indicators

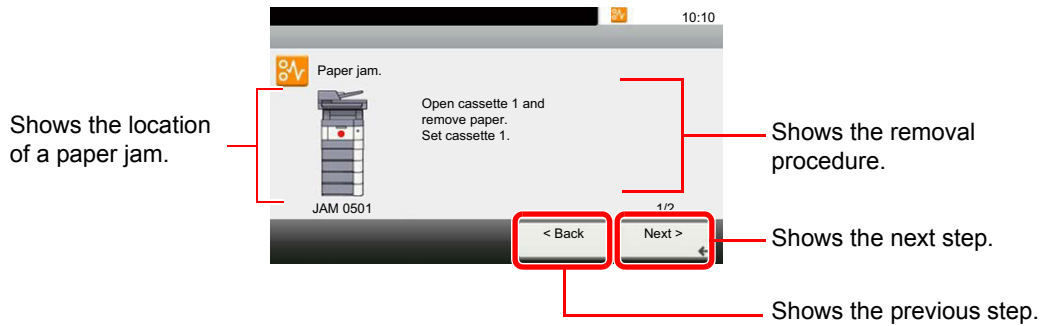

If a paper jam occurs, the location of the jam will be displayed on the touch panel as well as the clearing instructions.

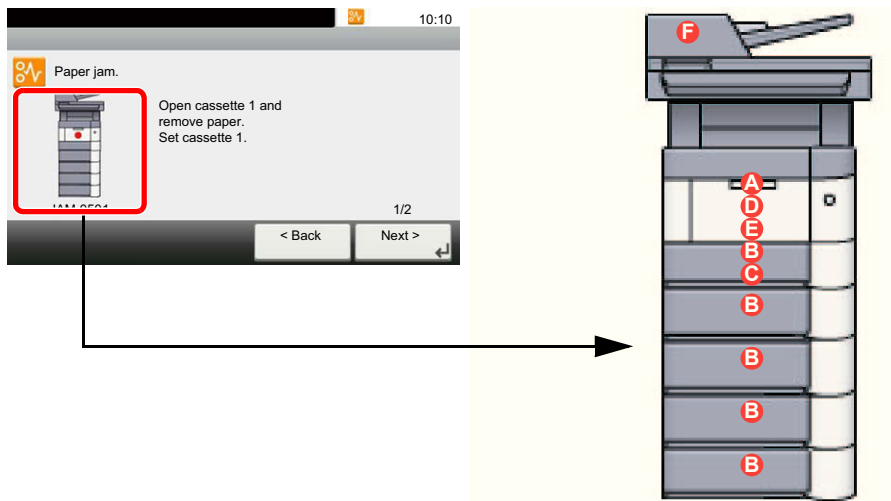

Paper Jam Location Indicator	Paper Jam Location	Reference Page
A	Multi Purpose Tray	<a href="#">page 10-27</a>
B	Cassettes 1 to 5	<a href="#">page 10-28</a>
C	Duplex Unit	<a href="#">page 10-29</a>
D	Inside the Machine	<a href="#">page 10-30</a>
E	Inner Tray / Inside Rear Cover	<a href="#">page 10-31</a>
F	Document Processor	<a href="#">page 10-32</a>

After you remove the jam, the machine will warm up again and the error message will be cleared. The machine resumes with the page that was printing when the jam occurred.

## Precautions with Paper Jams

- Do not reuse jammed papers.
- If the paper tears during removal, be sure to remove any loose scraps of paper from inside the machine. Scraps of paper left in the machine could cause subsequent jamming.



### CAUTION

The fixing unit is extremely hot. Take sufficient care when working in this area, as there is a danger of getting burned.

## Multi Purpose Tray

1

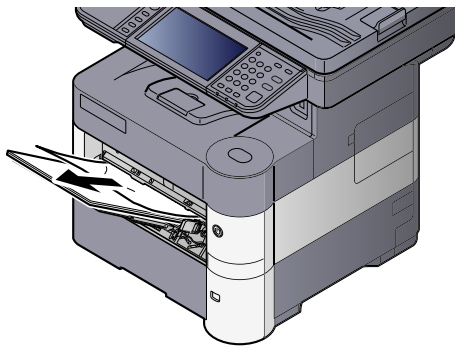

2

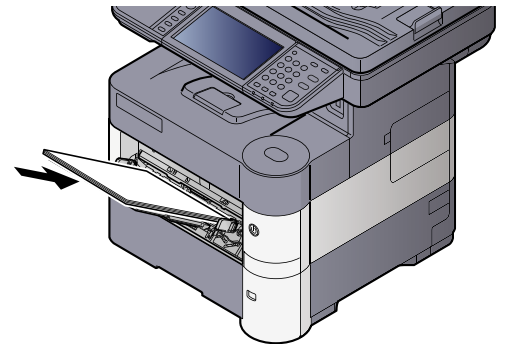
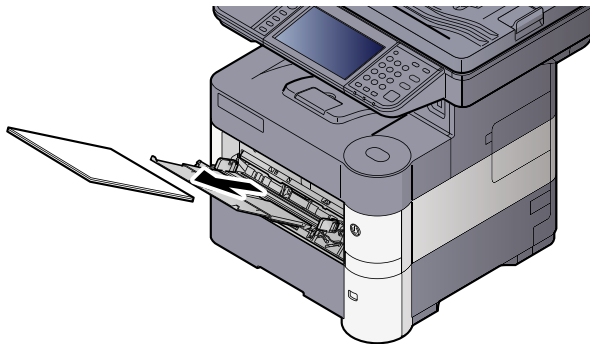

## Cassettes 1 to 5

Procedures for handling a paper jam in Cassettes 1 to 5 are all the same. This section explains procedures using Cassette 1 as an example.

1

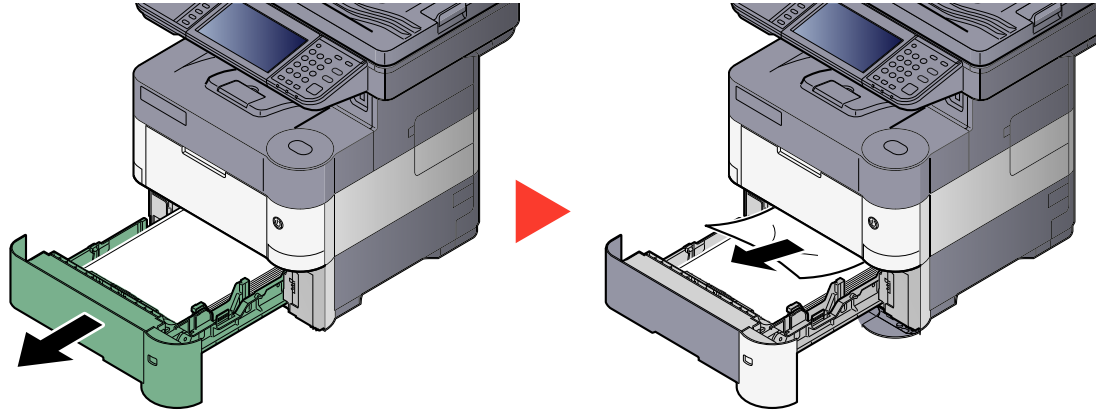

2

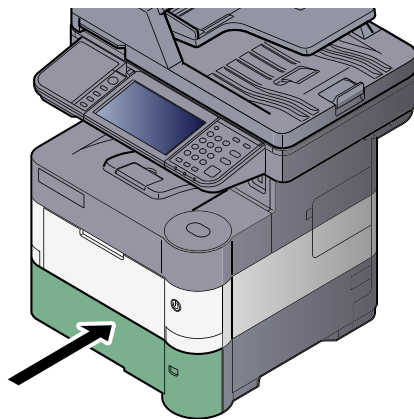



## Duplex Unit

1

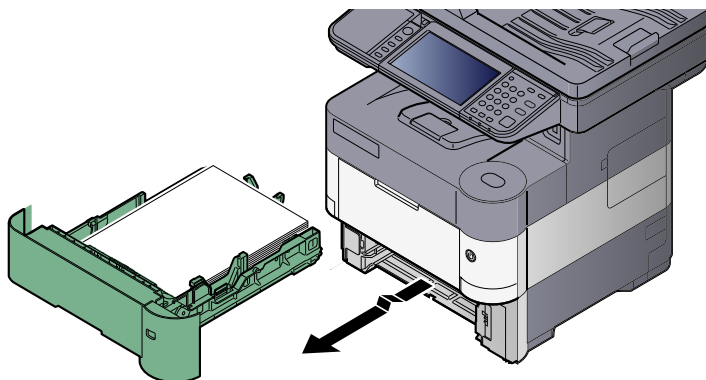

2

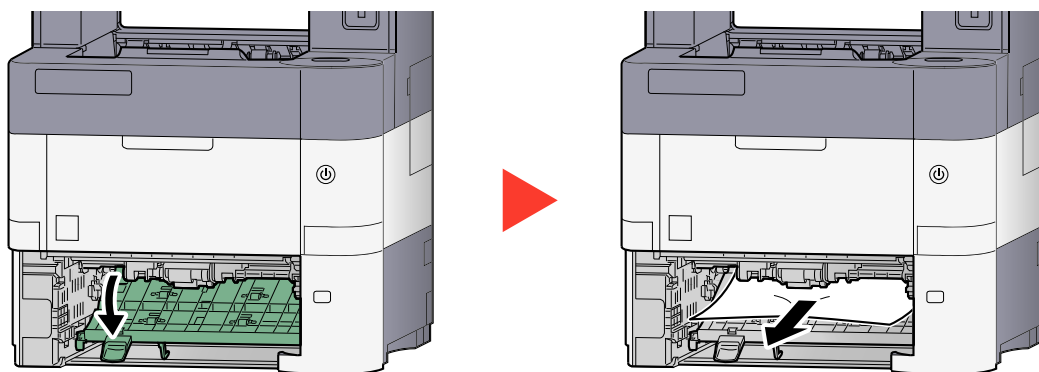

3

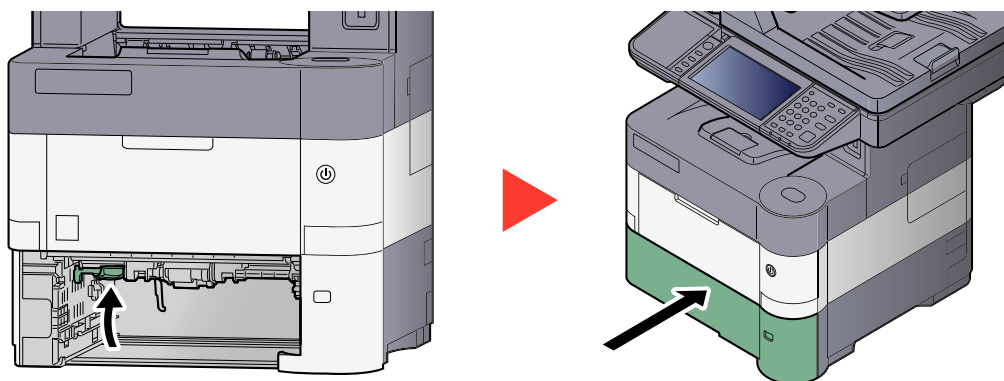

## Inside the Machine

1

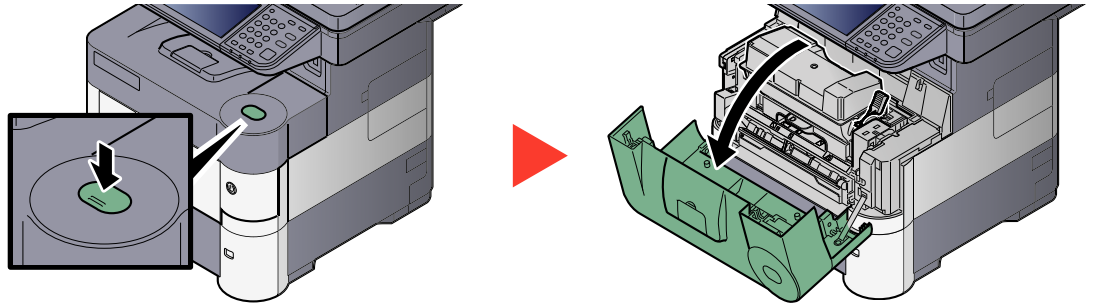

2

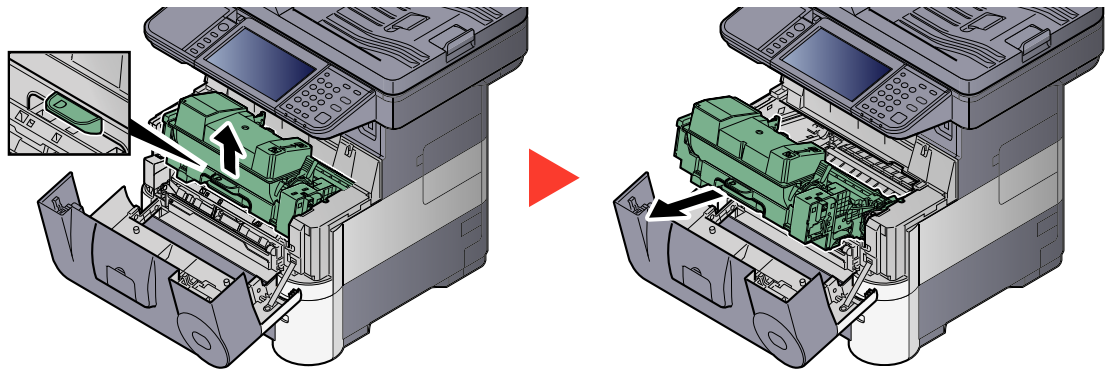

3

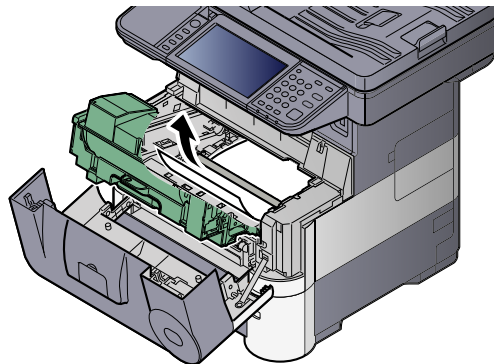

If the jammed paper appears to be pinched by rollers, pull it along the normal running direction of the paper.

If you cannot find a paper jam, try checking inside the rear of the printer. Refer to [Inner Tray / Inside Rear Cover](#) on page 10-31.

4

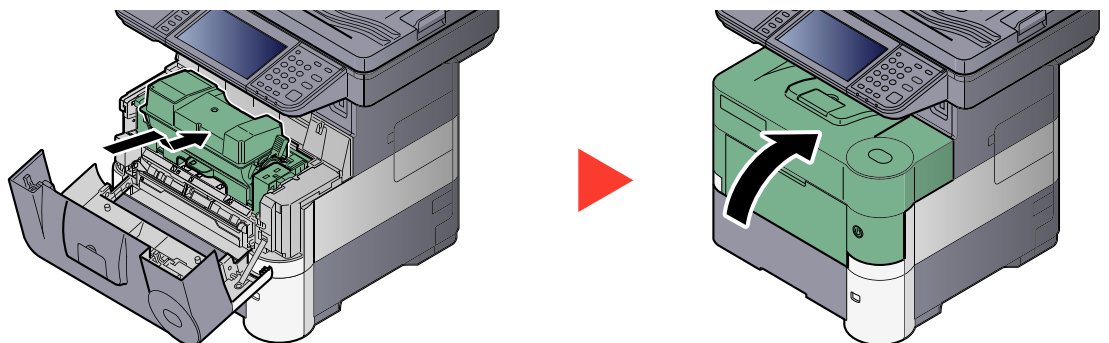

## Inner Tray / Inside Rear Cover

1

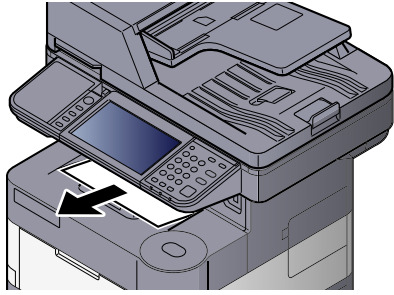

2

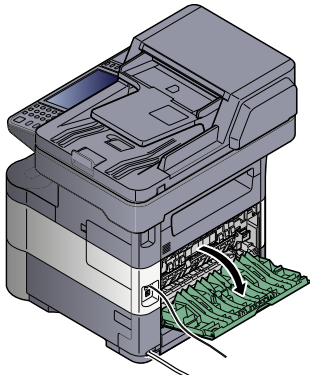

3

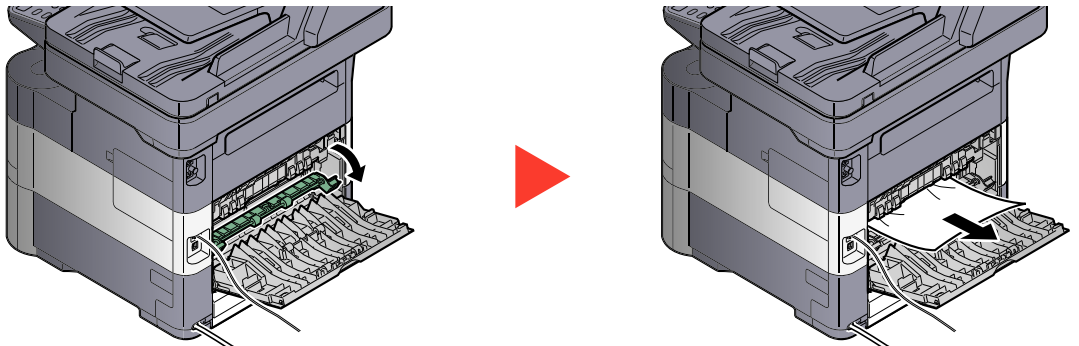

If you cannot find a paper jam, try checking inside the rear of the machine.

### CAUTION

The fixing unit is extremely hot. Take sufficient care when working in this area, as there is a danger of getting burned.

4

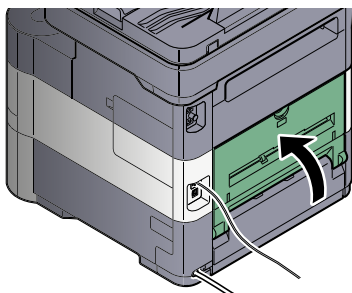

## Document Processor

1



2

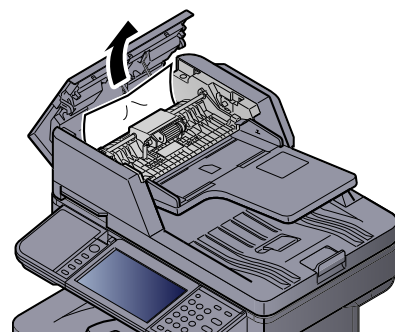
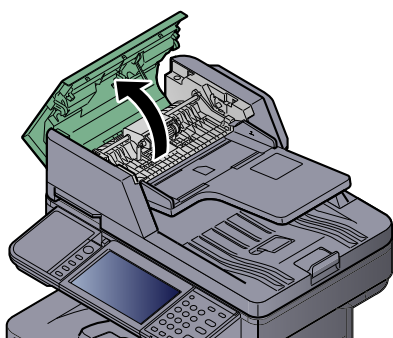

3

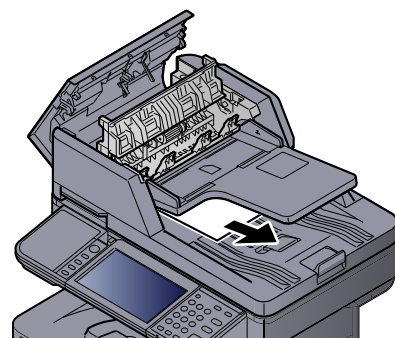
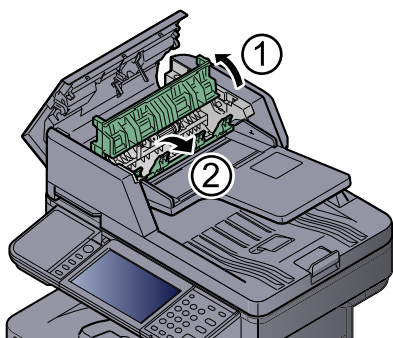

4

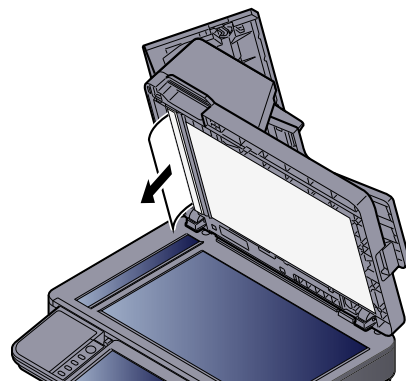
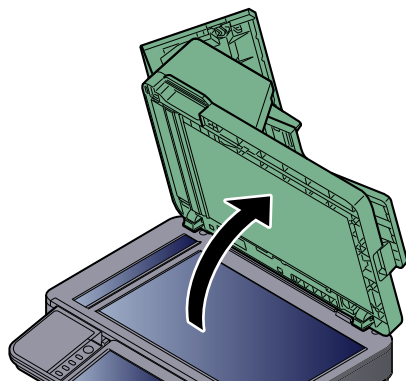

**5**

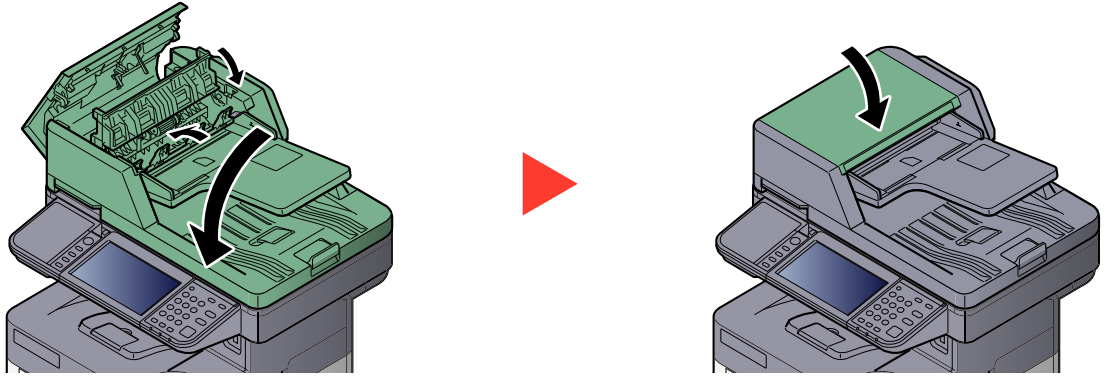

# 11 Appendix

This chapter explains the following topics:

Optional Equipment .....	11-2
Overview of Optional Equipment .....	11-2
Optional Applications .....	11-10
Character Entry Method .....	11-12
Entry Screens .....	11-12
Entering Characters .....	11-14
Paper .....	11-15
Basic Paper Specifications .....	11-15
Choosing the Appropriate Paper .....	11-16
Special Paper .....	11-19
Specifications .....	11-23
Common Functions .....	11-23
Copy Functions .....	11-25
Printer Functions .....	11-25
Scanner Functions .....	11-26
Document Processor .....	11-26
Paper Feeder (500-sheet) (Option) .....	11-27
Glossary .....	11-28

# Optional Equipment

## Overview of Optional Equipment

The following optional equipment is available for the machine.

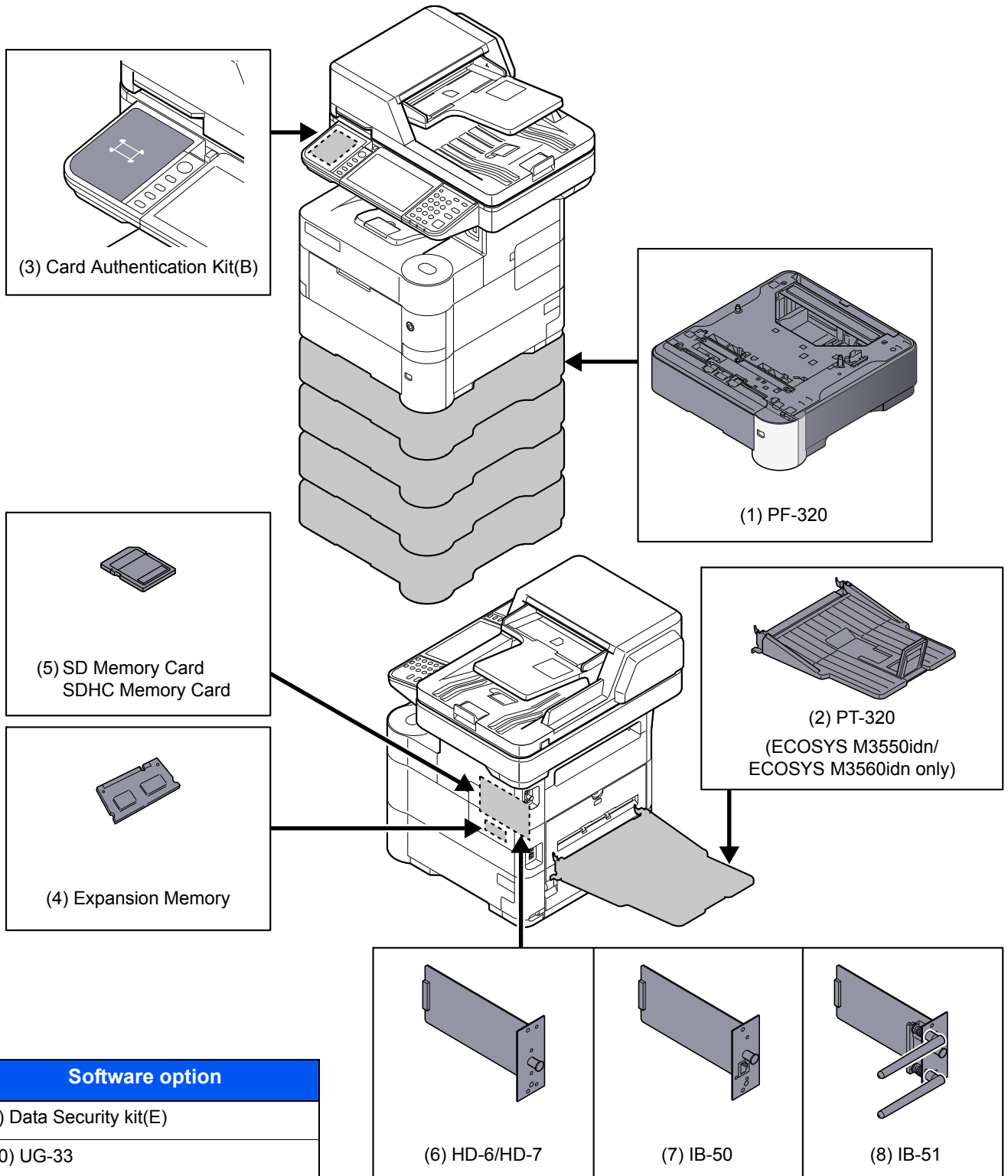

### (1) PF-320 "Paper Feeder (500-sheet x1)"

Up to four additional cassettes identical to the machine's cassettes can be installed in the machine. Paper capacity and loading method are the same as the standard cassettes. Refer to [Loading in the Cassettes on page 3-14](#) for loading paper.

### (2) PT-320 "Rear Tray" (ECOSYS M3550idn/ECOSYS M3560idn only)

Use the faceup output tray when you wish paper to be stacked with the printed side facing up (reverse order). The rear tray can only be used for printing from a PC.

#### Installing the Rear Tray

- 1 Install the paper stopper according to the size of paper to be used.

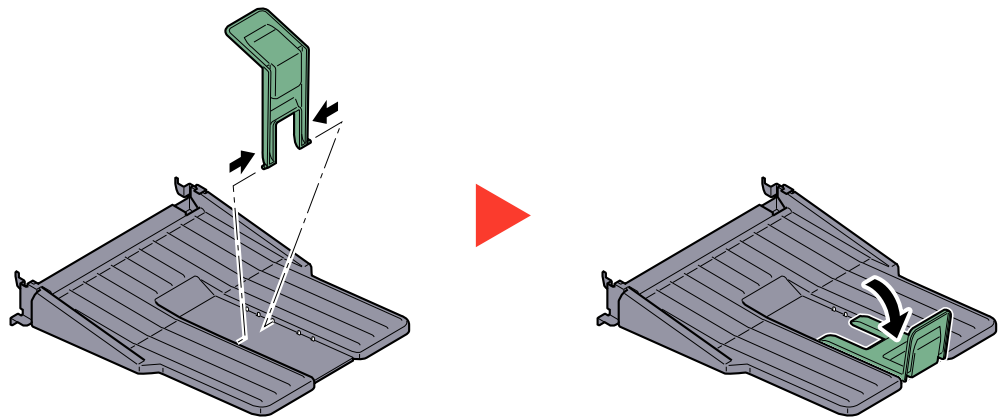

- 2 Install the rear tray on the rear of the machine.

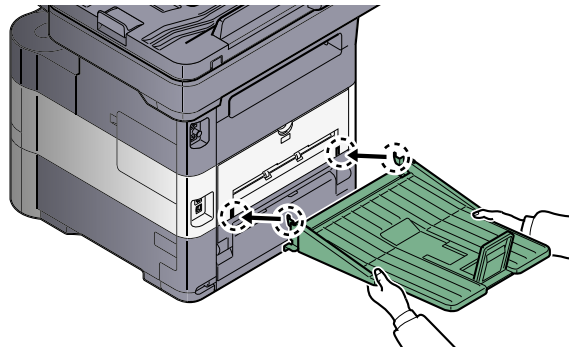

### (3) Card Authentication Kit(B) "Card Authentication Kit"

User login administration can be performed using ID cards. To do so, it is necessary to register ID card information on the previously registered local user list. For more information about how to register this information, refer to the **Card Authentication Kit(B) Operation Guide**.



## (4) "Expansion Memory"

The machine can perform the more multiple jobs simultaneously by adding more memories. You can increase the machine's memory up to 2,048 MB by plugging in the optional memory modules (512 MB, 1,024 MB).

### Precautions for Handling the Memory Modules

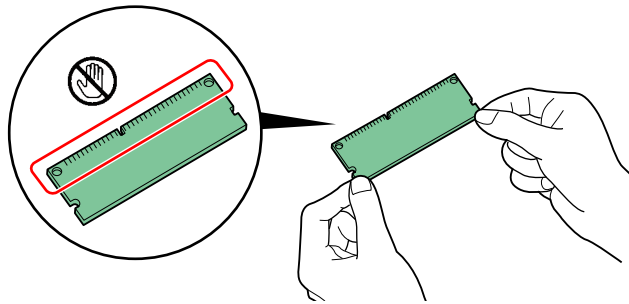

To protect electronic parts, discharge static electricity from your body by touching a water pipe (faucet) or other large metal object before handling the memory modules. Or, wear an antistatic wrist strap, if possible, when you install the memory modules.

### Installing the Memory Modules

- 1 Power off the machine and unplug the power cord.
- 2 Remove the covers.

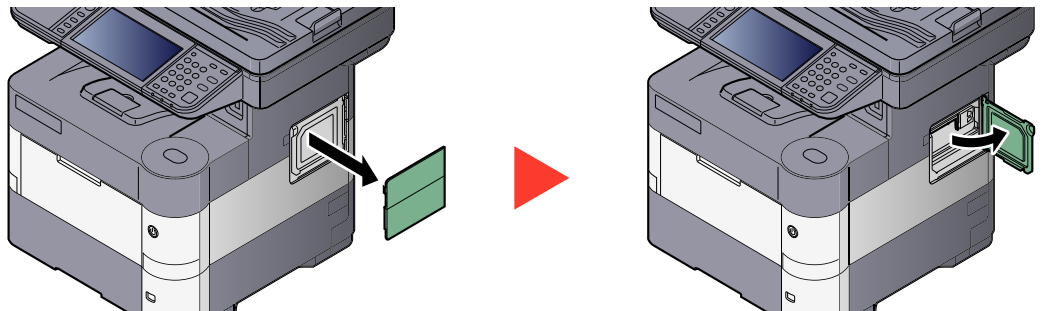

- 3 Remove the memory module from its package.
- 4 With the memory connection terminal pointing toward the socket, align the cut-out part with the socket terminal and insert directly in at an angle.

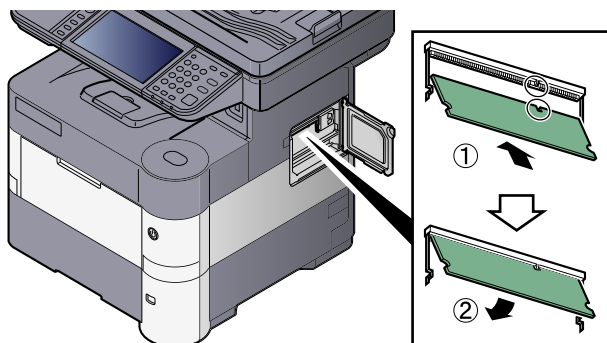

#### ✔ IMPORTANT

**Before inserting a memory module in the machine, make sure that the machine is switched off.**

- 5 Carefully press the inserted memory down and into the machine.
- 6 Reinstall the covers.

## Removing the Memory Module

To remove a memory module, remove the right cover and the memory slot cover from the machine. Then, carefully push out the two socket clamps. Ease the memory module out of the socket to remove.

## Verifying the Expanded Memory

To verify that the memory module is working properly, test it by printing a status page.

 [Report \(page 8-6\)](#)

## (5) "SD/SDHC Memory Card"

An SD/SDHC memory card is useful for storing fonts, macros, and overlays. The machine is equipped with a slot for an SDHC memory card with a maximum size of 32 GB, and an SD memory card with a maximum size of 2 GB.

## Reading the SD/SDHC Memory Card

Once inserted in the machine's slot, the contents of the SD/SDHC memory card can be read from the operation panel or automatically when you power on or reset the machine.

## Installing and Formatting the SD/SDHC Memory Card

To use an unused SD/SDHC memory card, you must first use the machine to format the SD/SDHC memory card.

- 1 Power off the machine and unplug the power cord.

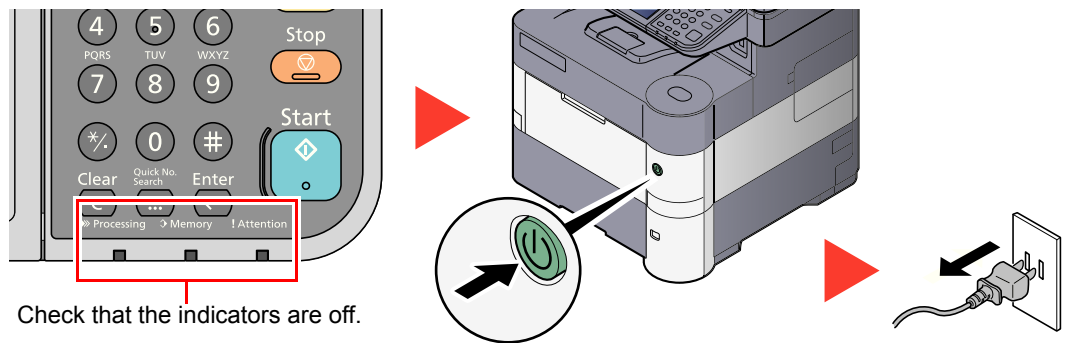

- 2 Open the rear cover and remove the two covers.

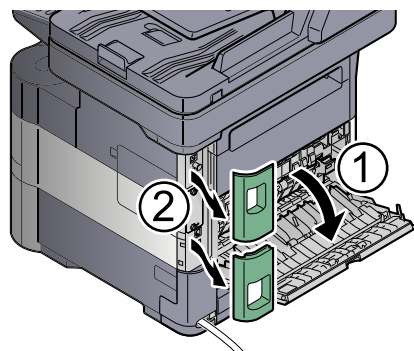

- 3** Remove the cover.

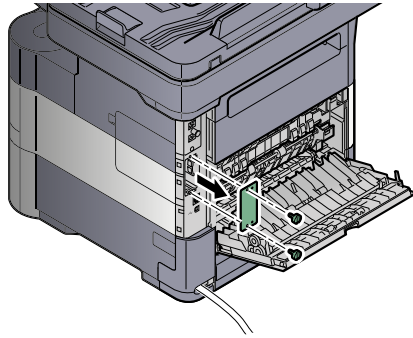

- 4** Insert the SD/SDHC memory card into the SD/SDHC memory card slot.

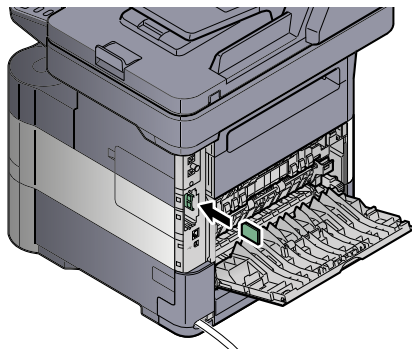

- 5** Replace the covers and close the rear cover.

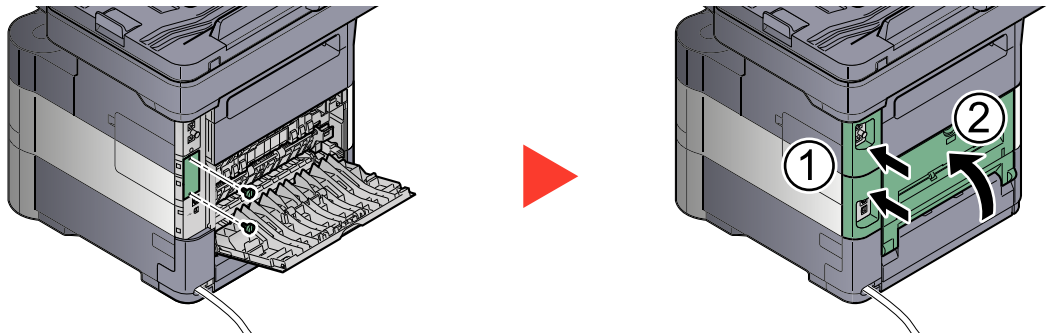

- 6** Insert the power cord into the socket and turn on the power switch.

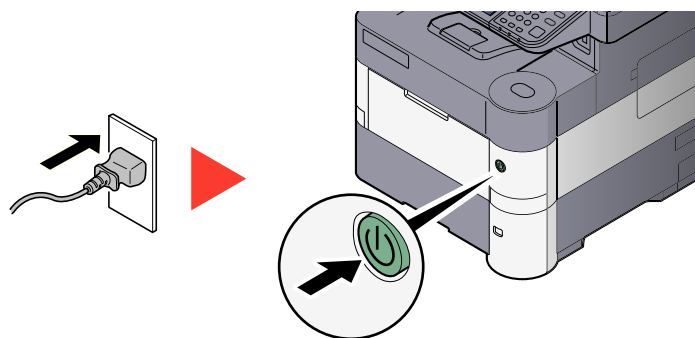

- 7** Format the SD/SDHC memory card from the operation panel. For the procedure for formatting, refer to [Format SD Card on page 8-19](#).

## (6) HD-6/HD-7 "SSD"

With SSD installed in the machine, received data can be rasterized and stored on this SSD. This enables high-speed printing of multiple copies using an electric sort function. Also, you can use the Document Box functions. For details, refer to [What is Document Box? on page 5-41](#).

### Installing SSD

- 1 Power off the machine and unplug the power cord.

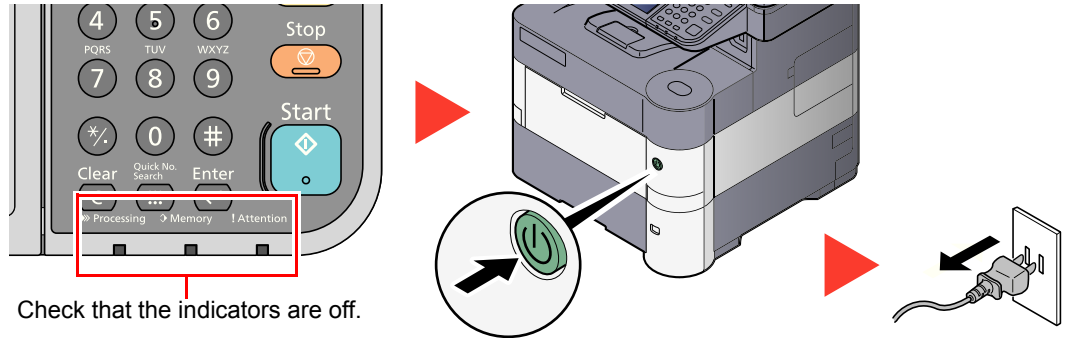

- 2 Open the rear cover and remove the two covers.

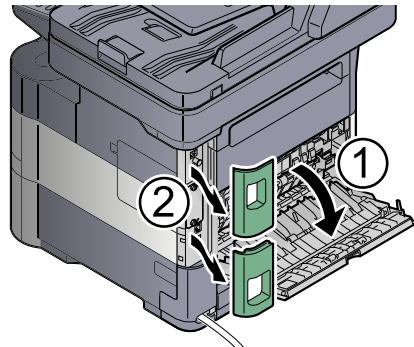

- 3 Remove the cover.

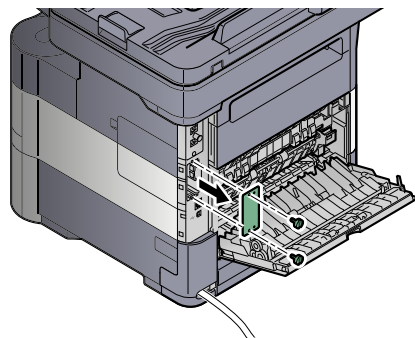

- 4 Insert straight into the Option Interface Slot.

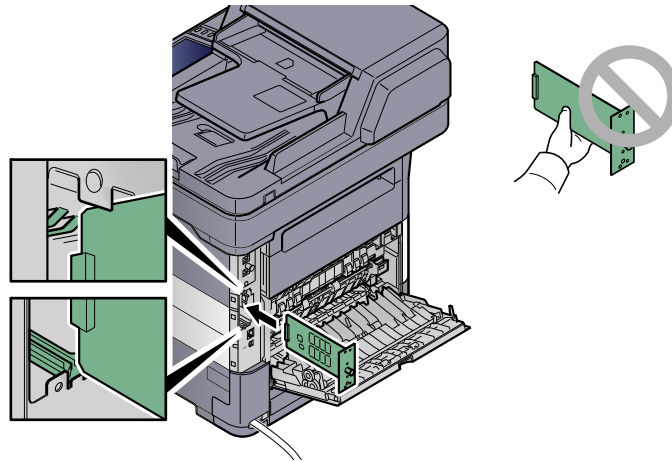

- 5 Fix it with the (2) screws.

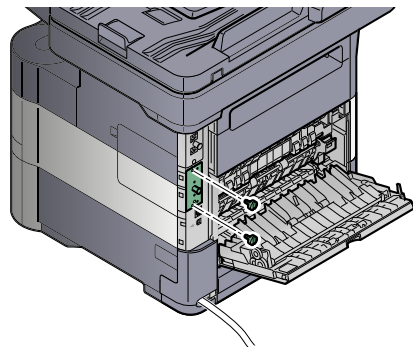

- 6 Replace the covers and close the rear cover.

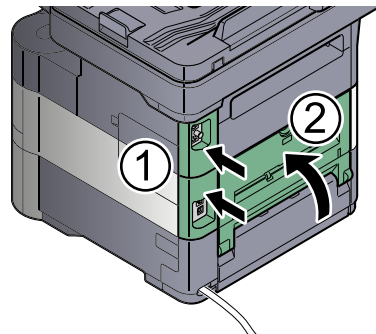

- 7 Insert the power cord into the socket and turn on the power switch.

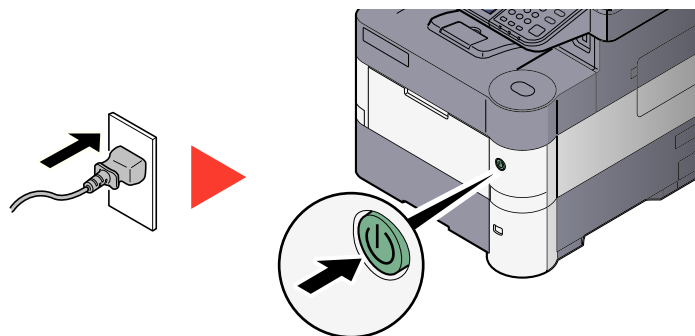

### **(7) IB-50 "Network Interface Kit"**

The Network Interface Kit provides a high-speed connection for the Gigabit-per-second interface. Settings are possible for a variety of OS and network protocols. For details, refer to **IB-50 User's Manual**.

The installation method is the same as for SSD. Refer to [HD-6/HD-7 "SSD" on page 11-7](#).

### **(8) IB-51 "Wireless Network Interface Kit"**

This is a wireless LAN interface card which supports the wireless LAN specifications IEEE802.11n (Max 300 Mbps) and 11 g/b. With the utilities supplied, settings are possible for a variety of OS and network protocols. For details, refer to **IB-51 User's Manual**.

The installation method is the same as for SSD. Refer to [HD-6/HD-7 "SSD" on page 11-7](#).

### **(9) Data Security Kit(E) "Data Security Kit"**

The Data Security Kit overwrites all unnecessary data in the storage area so that it cannot be retrieved. The Data Security Kit encrypts data before storing it in the SSD. It guarantees higher security because no data cannot be decoded by ordinary output or operations.

### **(10) UG-33 "ThinPrint Option"**

This application allows print data to be printed directly without a print driver.

### **(11) USB Keyboard "USB Keyboard"**

A USB keyboard can be used to enter information into the text fields on the operation panel. A special mount is also available to install the keyboard on the MFP. Please contact your dealer or service representative for information on keyboards that are compatible with your MFP before you purchase one.

# Optional Applications

## Overview of the Applications

The applications listed below are installed on this machine.

Application
Data Security Kit
Card Authentication Kit
ThinPrint Option *1

\*1 This can be used on a trial basis for a limited time.

### NOTE

- Restrictions such as the number of times the application can be used during the trial period differ depending on the application.
- If you change the date/time while using the trial version of an application, you will no longer be able to use the application.

## Starting Application Use

Use the procedure below to start using an application.

### 1 Display the screen.

- 1 Press the [System Menu/Counter] key.

System Menu /  
Counter



- 2 Press [∨], [System/Network], [∨] and then [Optional Function].

### NOTE

If the login user name entry screen appears during operations, enter a login user name and password, and press [Login].

The factory default login user name and login password are set as shown below.

Model Name	Login User Name	Login Password
ECOSYS M3040idn/ ECOSYS M3540idn	4000	4000
ECOSYS M3550idn	5000	5000
ECOSYS M3560idn	6000	6000

- 3 Select the desired application and press [Activate].

You can view detailed information on the selected application by pressing [].

- 4 Press [Official] and enter a license key.

Some applications do not require you to enter a license key. If the license key entry screen does not appear, go to Step 5.

To use the application as a trial, press [Trial] without entering the license key.

- 5 Press [Yes] in the confirmation screen.

**NOTE**

Icons of activated application are displayed in the Home screen.

## Checking Details of Application

Use the procedure below to check the details of application.

### 1 Display the screen.

- 1 Press the [System Menu/Counter] key.

System Menu /  
Counter



- 2 Press [∨], [System/Network], [∨] and then [Optional Function].

**NOTE**

If the login user name entry screen appears during operations, enter a login user name and password, and press [Login].

The factory default login user name and login password are set as shown below.

Model Name	Login User Name	Login Password
ECOSYS M3040idn/ ECOSYS M3540idn	4000	4000
ECOSYS M3550idn	5000	5000
ECOSYS M3560idn	6000	6000

- 3 Select the desired application and press [].

You can view detailed information on the selected application.



# Character Entry Method

To enter characters for a name, use the on-display keyboard in the touch panel following the steps as explained below.

## NOTE

### Keyboard Layout

"QWERTY", "QWERTZ" and "AZERTY" are available as keyboard layouts the same as a PC keyboard. Press the [System Menu/Counter] key, [Common Settings] and then [[Keyboard Layout] to choose the desired layout. "QWERTY" layout is used here as an example. You may use another layout following the same steps.

## Entry Screens

### Lower-case Letter Entry Screen

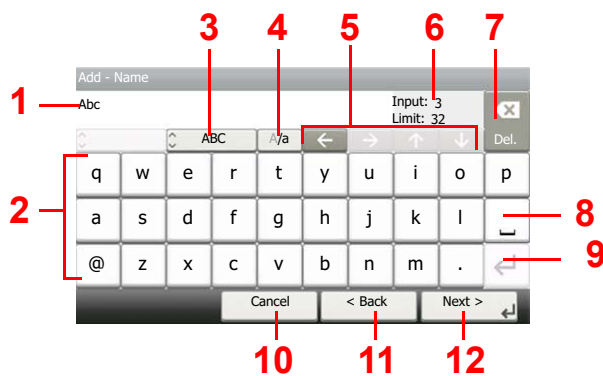

No.	Display/Key	Description
1	Display	Displays entered characters.
2	Keyboard	Press the character to enter.
3	[ABC] / [Symbol]	Select the characters that are entered. To enter symbols or numbers, select [Symbol].
4	[A/a] / [a/A]	Press to switch between upper case and lower case.
5	Cursor Key	Press to move the cursor on the display.
6	[Input] / [Limit] Display	Displays maximum number of characters and the number of characters entered.
7	Delete Key	Press to delete a character to the left of the cursor.
8	Space Key	Press to insert a space.
9	Enter Key	Press to enter a line break.
10	[Cancel]	Press to cancel entered characters and return to the screen before the entry was made.
11	[< Back]	Press to return to the previous screen.
12	[OK] / [Next >]	Press to save the entered characters and move to the next screen.

## Upper-case Letter Entry Screen



## Number/Symbol Entry Screen

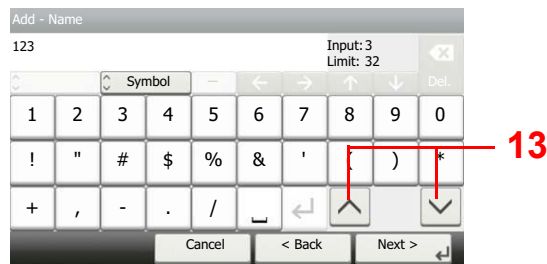

No.	Display/Key	Description
13	[▲]/[▼]	To enter a number or symbol not shown in the keyboard, press the cursor key and scroll the screen to view other numbers or symbols to enter.

## Entering Characters

Follow the steps below to enter 'List A-1' for an example.

### 1 Enter 'List', (space).



To shift from lower case to upper case letters, press [a/A]. To shift from upper case to lower case letters, press [A/a].

### 2 Enter 'A-1'.



To enter numbers or symbols, press [ABC] to display [Symbol].

### 3 Register the characters you entered.

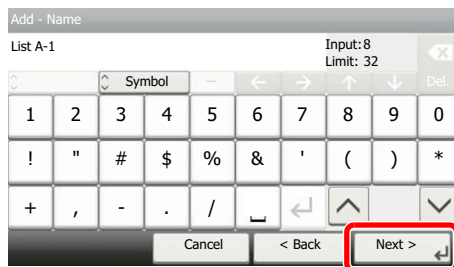

Press [Next>]. The entered characters are registered.

# Paper

This section explains the paper sizes and types that can be used in the paper source.

 For details on the sizes, types, and number of sheets of paper that can be loaded in each paper tray, refer to [Specifications on page 11-23](#).

## Basic Paper Specifications

This machine is designed to print on standard copy paper as used in regular ('dry') copiers and page printers such as laser printers. It also supports a variety of other types of paper that conform to the specifications given in this appendix.

Be careful when choosing paper. Paper unsuitable for the machine may cause jams or may be wrinkled.

### Supported Paper

Use standard copy paper for regular copiers or laser printers. The printing quality will be affected by the quality of paper. Poor quality paper may result in unsatisfactory output.

### Basic Paper Specifications

The following table lists the specifications of paper that is supported with this machine. Refer to the subsequent sections for further details.

Criteria	Specifications
Weight	Cassettes: 60 to 120 g/m <sup>2</sup>
	Multi purpose tray: 60 to 220 g/m <sup>2</sup> , 230 g/m <sup>2</sup> (Cardstock)
Dimensional accuracy	±0.7 mm
Squareness of corners	90° ±0.2°
Moisture content	4 to 6%
Pulp content	80% or more

#### NOTE

Some recycled paper does not meet requirements for use with this machine as listed in the Basic Paper Specifications shown below, such as moisture or pulp content. For this reason, we recommend purchasing a small amount of recycled paper as a sample for testing prior to use. Choose recycled paper that gives the best printing results and contains low levels of paper dust.

We are not responsible for the problems occurred from the use of paper that does not conform to our specifications.

## Choosing the Appropriate Paper

This section describes guidelines for choosing paper.

### Condition

Avoid using paper with bent corners or that is curled, dirty, or torn. Do not use paper that has a rough surface or paper fiber lint, or that is especially delicate. Use of paper in any of these conditions will not only deliver poor copies but may also cause jams and shorten the useful life of the machine. Choose paper with a smooth and even surface; however, avoid coated paper or paper with a treated surface as it may damage the drum or fusing unit.

### Ingredients

Do not use paper such as paper that has been coated or surface-treated or paper that contains plastic or carbon. Those types of paper may produce harmful fumes from the heat of printing and may damage the drum.

Be sure to use the standard paper that contains at least 80% pulp, i.e., not more than 20% of the total paper content consists of cotton or other fibers.

### Supported Paper Sizes

Paper of the following sizes is supported by the machine.

Measurements in the table take into account a  $\pm 0.7$  mm dimensional accuracy for length and width. Corner angles must be  $90^\circ \pm 0.2^\circ$ .

Paper Size	Cassette 1 (ECOSYS M3040idn/ ECOSYS M3540idn)	Cassette 1 (ECOSYS M3550idn/ ECOSYS M3560idn)	Cassettes 2 to 5	Multi Purpose Tray
Envelope Monarch (3-7/8 × 7-1/2")	×	×	○	○
Envelope #10 (4-1/8 × 9-1/2")	×	×	○	○
Envelope DL (110 × 220 mm)	×	○	○	○
Envelope C5 (162 × 229 mm)	○	○	○	○
Executive (7-1/4 × 10-1/2")	○	○	○	○
Letter	○	○	○	○
Legal	○	○	○	○
A4 (297 × 210 mm)	○	○	○	○
B5 (257 × 182 mm)	○	○	○	○
A5 (210 × 148 mm)	○	○	○	○
A6 (148 × 105 mm)	×	○	×	○
B6 (182 × 128 mm)	×	○	○	○
Envelope #9 (3-7/8 × 8-7/8")	×	×	○	○
Envelope #6 (3-5/8 × 6-1/2")	×	×	○	○
ISO B5 (176 × 250 mm)	○	○	○	○
Hagaki (100 × 148 mm)	×	×	×	○
Oufuku hagaki (148 × 200 mm)	×	○	○	○
Oficio II	○	○	○	○
216 × 340 mm	○	○	○	○
16K (273 × 197 mm)	○	○	○	○

Paper Size	Cassette 1 (ECOSYS M3040idn/ ECOSYS M3540idn)	Cassette 1 (ECOSYS M3550idn/ ECOSYS M3560idn)	Cassettes 2 to 5	Multi Purpose Tray
Statement	○	○	○	○
Folio (210 × 330 mm)	○	○	○	○
Youkei 4 (105 × 235 mm)	×	×	○	○
Youkei 2 (114 × 162 mm)	×	×	○	○
Custom	Cassette 1 ECOSYS M3040idn/ECOSYS M3540idn: 140 × 210 to 216 × 356 mm ECOSYS M3550idn/ECOSYS M3560idn: 105 × 148 to 216 × 356 mm Cassettes 2 to 5: 92 × 162 to 216 × 356 mm Multi Purpose Tray: 70 × 148 to 216 × 356 mm			

## Smoothness

The paper surface should be smooth, but it must be uncoated. With paper that is too smooth and slippery, several sheets may accidentally be supplied at once, causing jams.

## Basis Weight

In countries that use the metric system, basis weight is the weight in grams of one sheet of paper one square meter in area. In the United States, basis weight is the weight in pounds of one ream (500 sheets) of paper cut to the standard size (or trade size) for a specific grade of paper. Paper that is too heavy or too light may be supplied incorrectly or cause paper jams, which may cause excessive wear of the machine. Mixed paper weight (i.e., thickness) may cause several sheets to be supplied at once accidentally and may also cause blurring or other printing problems if the toner fails to adhere correctly.

## Moisture Content

Paper moisture content is the ratio of moisture to dryness expressed as a percentage. Moisture affects how the paper is supplied, the electrostatic chargeability of the paper, and how the toner adheres.

Paper moisture content varies depending on the relative humidity in the room. High relative humidity causes paper to become damp, making the edges expand so it appears wavy. Low relative humidity causes paper to lose moisture, making the edges tighten and weakening print contrast.

Wavy or tight edges may cause the paper to slip when it is supplied. Try to keep the moisture content between 4 to 6%.

To maintain the right level of moisture content, bear in mind the following considerations.

- Store paper in a cool, well-ventilated place.
- Store paper flat and unopened in the package. Once the package is opened, reseal it if the paper is not to be used for a while.
- Store paper sealed in the original package and box. Put a pallet under the carton to keep it raised above the floor. Especially during rainy seasons keep the paper a sufficient distance away from wooden or concrete floors.
- Before using paper that has been stored, keep it at the proper moisture level for at least 48 hours.
- Do not store paper where it is exposed to heat, sunlight, or dampness.

## Other Paper Specifications

**Porosity:** The density of the paper fibers

**Stiffness:** Paper must be stiff enough or it may buckle in the machine, causing jams.

**Curl:** Most paper naturally tends to curl after the package is opened. When paper passes through the fixing unit, it curls upward slightly. To deliver flat printouts, load the paper so that the curl faces towards the bottom of the paper tray.

**Static electricity:** During printing, paper is electrostatically charged so that the toner adheres. Choose paper that can be discharged quickly so that copies do not cling together.

**Whiteness:** Paper whiteness affects print contrast. Use whiter paper for sharper, brighter copies.

**Quality:** Machine problems may occur if sheet sizes are not uniform or if corners are not square, edges are rough, sheets are uncut, or edges or corners are crushed. In order to prevent these problems, be especially careful when you cut the paper yourself.

**Packaging:** Choose paper that is properly packaged and stacked in boxes. Ideally, the packaging itself should have been treated with a coating to inhibit moisture.

**Specially treated paper:** We do not recommend printing onto the following types of paper, even if it conforms to the basic specifications. When you use these kinds of paper, purchase a small amount first as a sample to test.

- Glossy paper
- Watermarked paper
- Paper with an uneven surface
- Perforated paper

## Special Paper

This section describes printing onto special paper and print media.

The following paper and media can be used.

- Transparencies
- Preprinted paper
- Bond paper
- Recycled paper
- Thin paper
- Letterhead
- Colored paper
- Prepunched paper
- Envelopes
- Cardstocks (Hagaki)
- Thick paper
- Labels
- High-quality paper

When using these paper and media, choose those that are designed specifically for copiers or page printers (such as laser printers). Use the multi purpose tray for transparencies, thick paper, envelopes, cardstocks, and label paper.

### Choosing Special Paper

Although special paper that meets the following requirements can be used with the machine, print quality will vary considerably due to differences in the construction and quality of special paper. Thus, special paper is more likely than regular paper to cause printing problems. Before purchasing special paper in volume, try testing a sample to ensure the print quality is satisfactory. General precautions when printing onto special paper are given below. Note that we are not responsible for any harm to the user or damage to the machine caused by moisture or specifications of special paper.

Select a cassette or multi purpose tray for special paper.

### Transparencies

Transparencies must be able to withstand the heat of printing. Transparencies must meet the following conditions.

<b>Heat resistance</b>	Must withstand at least 190°C
<b>Thickness</b>	0.100 to 0.110 mm
<b>Material</b>	Polyester
<b>Dimensional accuracy</b>	±0.7 mm
<b>Squareness of corners</b>	90° ±0.2°

To avoid problems, use the multi purpose tray for transparencies and load transparencies with the long side facing the machine.

If transparencies jam frequently at output, try pulling the leading edge of sheets gently as they are ejected.



## Label

Be sure to feed labels from the multi purpose tray.

For selecting labels, use extreme care so that the adhesive may not come in direct contact with any part of the machine and that the labels are not easily peeled from the carrier sheet. Adhesives that stick to the drum or rollers and peeled labels remaining in the machine may cause a failure.

When printing onto labels, you must be liable for the print quality and possible trouble.

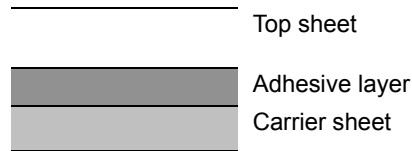

Labels consist of three layers as shown in the illustration. The adhesive layer contains materials that are easily affected by the force applied in the machine. The carrier sheet bears the top sheet until the label is used. This composition of labels may cause more problems.

The label surface must be covered completely with the top sheet. Gaps between labels may cause peeling of labels, resulting in a serious failure.

Some label paper has large margins on the top sheet. When using such paper, do not peel these margins from the carrier sheet before completing output.

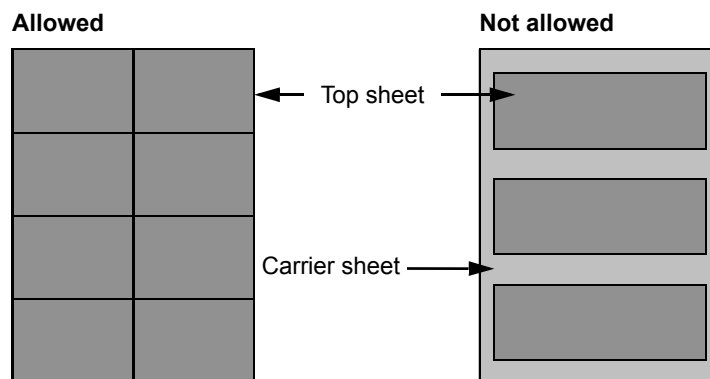

Use label paper that conforms to the following specifications.

<b>Top sheet weight</b>	44 to 74 g/m <sup>2</sup>
<b>Basis weight (overall paper weight)</b>	104 to 151 g/m <sup>2</sup>
<b>Top sheet thickness</b>	0.086 to 0.107 mm
<b>Overall paper thickness</b>	0.115 to 0.145 mm
<b>Moisture content</b>	4 to 6 % (composite)

## Hagaki

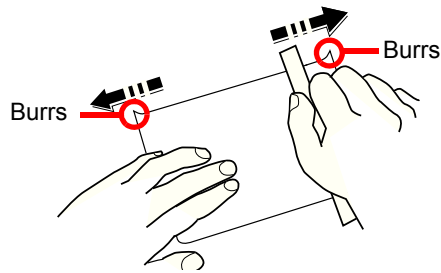

Before loading Hagaki into the multi purpose tray, fan them and align the edges. If the Hagaki paper is curled, straighten it before loading. Printing onto curled Hagaki may cause jams.

Use unfolded Oufuku hagaki (available at post offices). Some Hagaki may still have rough edges developed by a paper cutter on the back side. Remove any such rough edges by placing the Hagaki on a flat surface and rubbing the edges gently a few times with a ruler.

## Envelopes

Envelopes should be fed from the MP tray with the print-side up or the optional paper feeder (PF-320) with the print-side down.



### NOTE

Do not load paper above the load limits located on the paper width guide of the optional paper feeder.

For ECOSYS M3040idn/ECOSYS M3540idn, set envelope mode. Refer to [Switching to Envelop Mode \(ECOSYS M3040idn/ECOSYS M3540idn\) on page 3-20](#).

Due to the structure of envelopes, printing evenly over the entire surface may not be possible in some cases. Thin envelopes in particular may be wrinkled by the machine in some cases as they pass through. Before purchasing envelopes in volume, try testing a sample to ensure the print quality.

Storing envelopes for a long period may cause them to become wrinkled. Thus, keep the package sealed until you are ready to use them.

Keep the following points in mind.

- Do not use envelopes with exposed adhesive. In addition, do not use the type of envelope in which the adhesive is exposed after the top layer is peeled off. Serious damage may be caused if the paper covering the adhesive comes off in the machine.
- Do not use envelopes with certain special features. For example, do not use envelopes with a grommet for winding a string to close the flap or envelopes with an open or film-covered window.
- If paper jams occur, load fewer envelopes at once.
- To prevent paper jams when printing onto multiple envelopes, do not allow more than ten envelopes to remain in the Inner tray at once.

## Thick Paper

Before loading thick paper in the multi purpose tray, fan it and align the edges. Some thick paper may still have rough edges developed by a paper cutter on the back side. Remove any such rough edges just as with Hagaki by placing the paper on a flat surface and rubbing the edges gently a few times with a ruler. Printing onto paper with rough edges may cause jams.



### NOTE

If the paper is not supplied correctly even after it is smoothed, load the paper in the multi purpose tray with the leading edge raised a few millimeters.

## Colored Paper

Colored paper must conform to the specifications listed on page 11-15. In addition, the pigments in the paper must be able to withstand the heat of printing (up to 200°C or 392°F).

## Preprinted Paper

Preprinted paper must conform to the specifications listed on page 11-15. The colored ink must be able to withstand the heat of printing. It must be resistant to silicone oil as well. Do not use paper with a treated surface such as glossy paper used for calendars.

## Recycled Paper

Recycled paper must conform to the specifications listed on page 11-15; however, its whiteness may be considered separately.



### NOTE

Before purchasing recycled paper in volume, try testing a sample to ensure satisfactory print quality.

# Specifications

 **IMPORTANT**

Specifications are subject to change without notice.

 **NOTE**

For more information on using the FAX, refer to the **FAX Operation Guide**.

## Common Functions

Item		Description
<b>Type</b>		Desktop
<b>Printing Method</b>		Electrophotography by semiconductor laser
<b>Paper Weight</b>	<b>Cassette</b>	60 to 120 g/m <sup>2</sup>
	<b>Multi Purpose Tray</b>	60 to 220 g/m <sup>2</sup> , 230 g/m <sup>2</sup> (Cardstock)
<b>Paper Type</b>	<b>Cassette</b>	Plain, Rough, Recycled, Preprinted, Bond, Color (Colour), Prepunched, Letterhead, High Quality, Custom 1 to 8 (Duplex: Same as Simplex)
	<b>Multi Purpose Tray</b>	Plain, Transparency (OHP film), Rough, Vellum, Labels, Recycled, Preprinted, Bond, Cardstock, Color (Colour), Prepunched, Letterhead, Envelope, Thick, High Quality, Custom 1 to 8
<b>Paper Size</b>	<b>Cassette</b>	A4, A5, A6 <sup>*1</sup> , B5, B6 <sup>*1</sup> , Letter, Legal, Statement, Executive, Oficio II, Folio, 216 × 340 mm, 16K, ISO B5, Envelope DL <sup>*1</sup> , Envelope C5, Oufuku Hagaki <sup>*1</sup> , Custom
	<b>Multi Purpose Tray</b>	A4, A5, A6, B5, B6, Folio, 216 × 340 mm, Letter, Legal, Statement, Executive, Oficio II, 16K, ISO B5, Envelope #10, Envelope #9, Envelope #6, Envelope Monarch, Envelope DL, Envelope C5, Hagaki, Oufuku Hagaki, Youkei 4, Youkei 2, Custom
<b>Warm-up Time (22°C/71.6°F, 60%)</b>	<b>Power on</b>	ECOSYS M3040idn: 21 seconds or less ECOSYS M3540idn: 21 seconds or less ECOSYS M3550idn: 21 seconds or less ECOSYS M3560idn: 25 seconds or less
	<b>Low Power</b>	10 seconds or less
	<b>Sleep</b>	ECOSYS M3040idn: 15 seconds or less ECOSYS M3540idn: 15 seconds or less ECOSYS M3550idn: 20 seconds or less ECOSYS M3560idn: 25 seconds or less
<b>Paper Capacity</b>	<b>Cassette</b>	500 sheets (80 g/m <sup>2</sup> ) <sup>*2</sup>
	<b>Multi Purpose Tray</b>	100 sheets (80 g/m <sup>2</sup> )

\*1 ECOSYS M3550idn/ECOSYS M3560idn only.

\*2 Up to upper limit height line in the cassette.

Item		Description
Output Tray Capacity	Inner tray	ECOSYS M3040idn: 250 sheets (80 g/m <sup>2</sup> ) ECOSYS M3540idn: 250 sheets (80 g/m <sup>2</sup> ) ECOSYS M3550idn: 500 sheets (80 g/m <sup>2</sup> ) ECOSYS M3560idn: 500 sheets (80 g/m <sup>2</sup> )
	Rear tray <sup>*1</sup>	250 sheets (80 g/m <sup>2</sup> )
Image Write System		Semiconductor laser and electrophotography
Memory		1024 MB
Interface	Standard	USB Interface Connector: 1 (Hi-Speed USB) Network interface: 1 (10 BASE-T/100 BASE-TX/1000 BASE-T) USB Port: 2 (Hi-Speed USB) Fax: 1 <sup>*2</sup>
	Option	Network interface: 1 (10 BASE-T/100 BASE-TX/1000 BASE-T)
Operating Environment	Temperature	10 to 32.5°C/50 to 90.5°F
	Humidity	15 to 80 %
	Altitude	2,500 m/8,202 ft maximum
	Brightness	1,500 lux maximum
Dimension (W × D × H)		ECOSYS M3040idn/ECOSYS M3540idn: 18 11/16 × 17 15/16 × 22 5/8" 475 × 455 × 575 mm ECOSYS M3550idn/ECOSYS M3560idn: 18 11/16 × 17 15/16 × 23 1/4" 475 × 455 × 590 mm (without document processor tray)
Weight		ECOSYS M3040idn/ECOSYS M3540idn: Approx. 48.4 lb/Approx. 22.0 kg ECOSYS M3550idn/ECOSYS M3560idn: Approx. 51.26 lb/Approx. 23.3 kg (without toner container)
Space Required (W × D) (Using multi purpose tray)		18 11/16 × 24 7/8" 475 × 632 mm
Power Source		ECOSYS M3040idn/ECOSYS M3540idn 120 V Specification Model: 120 V ~ 60 Hz 8.4 A 230 V Specification Model: 220 to 240 V ~ 50/60 Hz 4.4 A ECOSYS M3550idn/ECOSYS M3560idn 120 V Specification Model: 120 V ~ 60 Hz 10.4 A 230 V Specification Model: 220 to 240 V ~ 50/60 Hz 5.2 A
Options		Refer to <a href="#">Optional Equipment on page 11-2</a> .

\*1 ECOSYS M3550idn/ECOSYS M3560idn only.

\*2 Only on products with the fax function installed.

## Copy Functions

Item		Description	
Copy Speed	ECOSYS M3040idn/ ECOSYS M3540idn	A4-R	40 sheets/min
		Letter-R	42 sheets/min
		Legal	33 sheets/min
		B5-R	33 sheets/min
		A5-R	22 sheets/min
	ECOSYS M3550idn	A4-R	50 sheets/min
		Letter-R	52 sheets/min
		Legal	42 sheets/min
		B5-R	40 sheets/min
A5-R/A6-R		27 sheets/min	
ECOSYS M3560idn	A4-R	60 sheets/min	
	Letter-R	62 sheets/min	
	Legal	50 sheets/min	
	B5-R	48 sheets/min	
	A5-R/A6-R	32 sheets/min	
First Copy Time (A4, feed from Cassette)	Black and White	ECOSYS M3040idn/ECOSYS M3540idn: 9.0 seconds or less ECOSYS M3550idn/ECOSYS M3560idn: 8.0 seconds or less	
Zoom Level		Manual mode: 25 to 400%, 1% increments Auto mode: Preset Zoom	
Continuous Copying		1 to 999 sheets	
Resolution		600 × 600 dpi	
Supported Original Types		Sheet, Book, 3-dimensional objects (maximum original size: Legal/Folio)	
Original Feed System		Fixed	

## Printer Functions

Item		Description	
Printing Speed		Same as Copying Speed.	
First Print Time (A4, feed from Cassette)	Black and White	ECOSYS M3040idn/ECOSYS M3540idn: 9.0 seconds or less ECOSYS M3550idn/ECOSYS M3560idn: 8.0 seconds or less	
Resolution		Fast1200, 600 dpi, 300 dpi	
Operating System		Windows XP, Windows Server 2003, Windows Vista, Windows 7, Windows 8, Windows Server 2008/R2, Windows Server 2012, Mac OS 10.5 or later	
Interface		USB Interface Connector: 1 (Hi-Speed USB) Network interface: 1 (10 BASE-T/100 BASE-TX/1000 BASE-T) Optional Interface (Option): 1 (For IB-50/IB-51 mounting)	
Page Description Language		PRESCRIBE	
Emulations		PCL6 (PCL5e, PCL-XL, PCL5c), KPDL3, XPS, Line Printer, IBM Proprinter, EPSON LQ-850	

## Scanner Functions

Item	Description	
<b>Resolution</b>	600×600 dpi, 400×400 dpi, 300×300 dpi, 200×400 dpi, 200×200 dpi, 200×100 dpi	
<b>File Format</b>	TIFF (MMR/JPEG compression), JPEG, PDF (MMR/JPEG compression), XPS, PDF/A, High compressive PDF	
<b>Scanning Speed<sup>*1</sup></b>	ECOSYS M3040idn/ ECOSYS M3540idn	1-sided      B/W 40 Images/min Color 30 Images/min 2-sided      B/W 17 Images/min Color 13 Images/min (A4 landscape, 300 dpi, Image quality: Text/Photo original)
	ECOSYS M3550idn/ ECOSYS M3560idn	1-sided      B/W 60 Images/min Color 40 Images/min 2-sided      B/W 26 Images/min Color 17 Images/min (A4 landscape, 300 dpi, Image quality: Text/Photo original)
<b>Interface</b>	Ethernet (10 BASE-T/100 BASE-TX/1000 BASE-T), USB	
<b>Transmission System</b>	SMB, SMTP, FTP, FTP over SSL, USB, TWAIN <sup>*2</sup> , WIA <sup>*3</sup> , WSD	

\*1 When using the document processor (except TWAIN and WIA scanning)

\*2 Available Operating System: Windows XP/Windows Server 2003/Windows Vista/Windows Server 2008/Windows Server 2008 R2/Windows 7/Windows 8/Windows Server 2012

\*3 Available Operating System: Windows Vista/Windows Server 2008/Windows Server 2008 R2/Windows 7/Windows 8/Windows Server 2012

## Document Processor

Item	Description
<b>Original Feed Method</b>	Automatic feed
<b>Supported Original Types</b>	Sheet originals
<b>Paper Size</b>	Maximum: Legal/Folio Minimum: Statement-R/A6-R
<b>Paper Weight</b>	1-sided: 50 to 120 g/m <sup>2</sup> 2-sided: 50 to 120 g/m <sup>2</sup>
<b>Loading Capacity</b>	75 sheets (50 to 80 g/m <sup>2</sup> ) maximum <sup>*1</sup>

\*1 Up to upper limit height line in the document processor

## Paper Feeder (500-sheet) (Option)

Item	Description
<b>Paper Supply Method</b>	Friction retard feeder (No. Sheets: 500, 80 g/m <sup>2</sup> )
<b>Paper Size</b>	A4, A5, B5, B6, Folio, 216 × 340 mm, Letter, Legal, Statement, Executive, Oficio II, 16K, ISO B5, Envelope #10, Envelope #9, Envelope #6, Envelope Monarch, Envelope DL, Envelope C5, Oufuku Hagaki, Youkei 4, Youkei 2, Custom (92 × 162 to 216 × 356 mm)
<b>Supported Paper</b>	Paper weight: 60 to 120 g/m <sup>2</sup> Media types: Plain, Rough, Recycled, Preprinted, Bond, Color (Colour), Prepunched, Letterhead, Envelope, High Quality, Custom 1 to 8
<b>Dimensions (W) × (D) × (H)</b>	15 × 16 1/8 × 4 3/4" 380 × 410 × 121 mm
<b>Weight</b>	8.8 lbs. or less/ 4.0 kg or less



### NOTE

Consult your dealer or service representative for recommended paper types.



# Glossary

## Accessibility

The machine is designed featuring good accessibility even for the elderly and those who are physically challenged or visually impaired. Touch panel is adjustable in two angles.

## Auto Form Feed Timeout

During data transmission, the machine may sometimes have to wait until receiving the next data. This is the auto form feed timeout. When the preset timeout passes, the machine automatically prints output. However, no output is performed if the last page has no data to be printed.

## Auto-IP

Auto-IP is a module that enables dynamic IPv4 addresses to be assigned to a device on startup. However, DHCP requires a DHCP server. Auto-IP is a server-less method of choosing an IP address. IP addresses between 169.254.0.0 to 169.254.255.255 are reserved for Auto-IP and assigned automatically.

## Auto Paper Selection

A function to automatically select paper in the same size as originals when printing

## Auto Sleep

A mode designed for electrical power saving, activated when the machine is left unused or there is no data transfer for a specific period. In Sleep mode, power consumption is kept to a minimum.

## Bonjour

Bonjour, also known as zero-configuration networking, is a service that automatically detects computers, devices and services on an IP network. Bonjour, because an industry-standard IP protocol is used, allows devices to automatically recognize each other without an IP address being specified or DNS server being set. Bonjour also sends and receives network packets by UDP port 5353. If a firewall is enabled, the user must check that UDP port 5353 is left open so that Bonjour will run correctly. Some firewalls are set up so as to reject only certain Bonjour packets. If Bonjour does not run stably, check the firewall settings and ensure that Bonjour is registered on the exceptions list and that Bonjour packets are accepted. If you install Bonjour on Windows XP Service Pack 2 or later, the Windows firewall will be set up correctly for Bonjour.

## Default Gateway

This indicates the device, such as a computer or router, that serves as the entrance/exit (gateway) for accessing computers outside the network that you are on. When no specific gateway is designated for a destination IP address, data is sent to the host designated as the Default Gateway.

## DHCP (Dynamic Host Configuration Protocol)

Dynamic Host Configuration Protocol (DHCP) that automatically resolves IP addresses, subnet masks, and gateway addresses on a TCP/IP network. DHCP minimizes the load of network management employing a large number of client computers because it relieves individual clients including printers from the IP address being assigned.

## DHCP (IPv6)

DHCP (IPv6) is the next-generation of the Internet's Dynamic Host Configuration Protocol and supports IPv6. It extends the BOOTP startup protocol that defines the protocols used for transferring configuration information to hosts on the network. DHCP (IPv6) permits the DHCP server to use its expanded functionality to send configuration parameters to an IPv6 node. Because the network addresses that can be used are allocated automatically, the IPv6 node management workload is reduced in systems where the administrator has to exercise close control over IP address allocation.

## **dpi (dots per inch)**

A unit for resolution, representing the number of dots printed per inch (25.4 mm).

## **EcoPrint Mode**

A printing mode that helps save toner. Copies made in this mode are thus lighter than normal.

## **Emulation**

The function to interpret and execute other printers' page description languages. The machine emulates operation of PCL6, KPDL3 (PostScript 3 compatible).

## **FTP (File Transfer Protocol)**

A protocol to transfer files on the TCP/IP network, whether the Internet or an intranet. Along with HTTP and SMTP/POP, FTP is now frequently used on the Internet.

## **Grayscale**

A computer color expression. Displayed images of this sort are typically composed of shades of gray, varying from black at the weakest intensity to white at the strongest, without any other colors. Gray levels are displayed in numerical levels: that is, white and black only for 1 bit; 256 gray levels (including white and black) for 8 bits; and 65,536 gray levels for 16 bits.

## **Help**

A ? (Help) key is provided on this machine's operation panel. If you are unsure of how to operate the machine, would like more information on its functions or are having problems getting the machine to work properly, press the ? (Help) key to view a detailed explanation on the touch panel.

## **IP Address**

An Internet protocol address is a unique number that represents a specific computer or related device on the network. The format of an IP address is four sets of numbers separated by dots, e.g. 192.168.110.171. Each number should be between 0 and 255.

## **IPP**

IPP (Internet Printing Protocol) is a standard that uses TCP/IP networks such as the Internet to enable print jobs to be sent between remote computers and printers. IPP is an extension of the HTTP protocol used to view websites and enables printing to be carried out via routers on printers in remote locations. It also supports the HTTP authentication mechanisms along with SSL server and client authentication as well as encryption.

## **KPDL (Kyocera Page Description Language)**

Kyocera's PostScript page description language compatible with Adobe PostScript Level 3.

## **Multi Purpose (MP) Tray**

The paper supply tray on the right side of the machine. Use this tray instead of the cassettes when printing onto envelopes, Hagaki, transparencies, or labels.

## **NetBEUI (NetBIOS Extended User Interface)**

An interface, developed by IBM in 1985, as an update from NetBIOS. It enables more advanced functions on smaller networks than other protocols such as TCP/IP, etc. It is not suitable for larger networks due to lack of routing capabilities to choose the most appropriate routes. NetBEUI has been adopted by IBM for its OS/2 and Microsoft for its Windows as a standard protocol for file sharing and printing services.

## **PDF/A**

This is "ISO 19005-1. Document management - Electronic document file format for long-term preservation - Part 1: Use of PDF (PDF/A)", and is a file format based on PDF 1.4. It has been standardized as ISO 19005-1, and is a specialization of PDF, which has been mainly used for printing, for long-term storage. A new part, ISO 19005-2 (PDF/A-2), is currently being prepared.

## **POP3 (Post Office Protocol 3)**

A standard protocol to receive E-mail from the server in which the mail is stored on the Internet or an intranet.

## **PostScript**

A page description language developed by Adobe Systems. It enables flexible font functions and highly-functional graphics, allowing higher quality printing. The first version called Level 1 was launched in 1985, followed by Level 2 that enabled color printing and two-byte languages (e.g. Japanese) in 1990. In 1996, Level 3 was released as an update for the Internet access and PDF format as well as gradual improvements in implementation technologies.

## **PPM (prints per minute)**

This indicates the number of A4 size printouts made in one minute.

## **Printer Driver**

The software to enable you to print data created on any application software. The printer driver for the machine is contained in the DVD enclosed in the package. Install the printer driver on the computer connected to the machine.

## **RA(Stateless)**

The IPv6 router communicates (transmits) information such as the global address prefix using ICMPv6. This information is the Router Advertisement (RA). ICMPv6 stands for Internet Control Message Protocol, and is a IPv6 standard defined in the RFC 2463 "Internet Control Message Protocol (ICMPv6) for the Internet Protocol Version 6 (IPv6) Specification".

## **Send as E-mail**

A function to send the image data stored in the machine as an E-mail attachment. E-mail addresses can be selected from the list or entered at each time.

## **SMTP (Simple Mail Transfer Protocol)**

A protocol for E-mail transmission over the Internet or an intranet. It is used for transferring mail between mail servers as well as for sending mail from clients to their servers.

## **Status Page**

The page lists machine conditions, such as the memory capacity, total number of prints and scans, and paper source settings.

## **Subnet Mask**

The subnet mask is a way of augmenting the network address section of an IP address. A subnet mask represents all network address sections as 1 and all host address sections as 0. The number of bits in the prefix indicates the length of the network address. The term "prefix" refers to something added to the beginning and, in this context, indicates the first section of the IP address. When an IP address is written, the length of the network address is indicated by the prefix length after a forward slash (/). For example, "24" in the address "133.210.2.0/24". In this way, "133.210.2.0/24" denotes the IP address "133.210.2.0" with a 24-bit prefix (network section). This new network address section (originally part of the host address) made possible by the subnet mask is referred to as the subnet address. When you enter the subnet mask, be sure to set the "DHCP" setting to "Off".

## **TCP/IP (Transmission Control Protocol/Internet Protocol)**

TCP/IP is a suite of protocols designed to define the way computers and other devices communicate with each other over a network.

## **TCP/IP (IPv6)**

TCP/IP (IPv6) is based on the current Internet protocol, TCP/IP (IPv4). IPv6 is the next-generation Internet protocol and expands the available address space, which resolves the problem of the lack of addresses under IPv4, while also introducing other improvements such as additional security functionality and the capacity to prioritize data transmission.

## **TWAIN (Technology Without An Interesting Name)**

A technical specification for connecting scanners, digital cameras, and other image equipment to computers. The TWAIN compatible devices enable you to process image data on any relevant application software. TWAIN is adopted on a large amount of graphic software (e.g. Adobe Photoshop) and OCR software.

## **USB (Universal Serial Bus) 2.0**

A USB interface standard for Hi-Speed USB 2.0. The maximum transfer rate is 480 Mbps. This machine is equipped with USB 2.0 for high-speed data transfer.

## **WIA (Windows Imaging Acquisition)**

A function to import images supported after Windows Me/XP from digital cameras and other peripheral devices. This function replaces what TWAIN used to do. The feature is provided as a part of Windows functions and improves ease of operation, so that you import images directly to My Computer without using any application.

---

# Index

## A

- Accessibility 11-28
- Address Book 3-35
  - Adding 3-35
  - Contact 3-35
  - Editing and Deleting 3-39
  - Group 3-38
- Address Book/One Touch 8-23
- Adjustment/Maintenance 8-40
- AirPrint 4-7
- Apache License (Version 2.0) 1-14
- Application 5-11, 8-23
- Auto Color Correction 8-40
- Auto Drum Refresh 8-41
- Auto Error Clear 8-39
- Auto Form Feed Timeout 11-28
- Auto Low Power Mode 2-14
- Auto Panel Reset 8-37
- Auto Paper Selection 11-28
- Auto Sleep 2-15, 11-28
- Auto-IP 11-28
  - Settings 8-27
- Automatic 2-Sided Copy Function 1-17

## B

- Background Density Adjustment 6-13, 8-40
  - Default 8-16
- Bonjour 11-28
  - Setup 8-28

## C

- Cables 2-5
- Card Authentication Kit 11-3
- Card Reader 2-4
- Cassette
  - Loading Paper 3-14
  - Paper Size and Media Type 3-22, 8-9
- Cassette 1 2-2
- Cassette Settings 3-22
- Cassette/MP Tray Settings 8-9
- Cassettes 2 to 5 2-4
- Character Entry Method 11-12
- Checking the Counter 2-31
- Cleaning
  - Glass Platen 10-2
  - Registration Roller 10-3
  - Slit Glass 10-2
- Collate 6-10
  - Default 8-15
- Color Selection 6-12
  - Default 8-15
- Combine 6-16
- Command Center RX 2-34

- Common Settings 8-11
  - Default Screen 8-11
  - Display Status/Log 8-19
  - Error Handling 8-17
  - Format SD Card 8-19
  - Format SSD 8-18
  - Function Defaults 8-15
  - Function Key Usage 8-19
  - Keyboard Layout 8-18
  - Low Toner Alert Level 8-18
  - Measurement 8-17
  - Original Settings 8-12
  - Paper Settings 8-13
  - Preset Limit 8-17
  - Sound 8-11
  - USB Keyboard Type 8-18
- Connecting
  - LAN Cable 2-6
  - Power Cable 2-7
  - USB cable 2-7
- Connection Method 2-5
- Continuous Scan 6-19
  - Default 8-16
- Conventions Used in This Guide xv
- Copy 5-16
- Copy Settings 8-20
  - Auto % Priority 8-20
  - Auto Paper Selection 8-20
  - DP Read Action 8-20
  - Reserve Next Priority 8-20
- Copy Speed 11-25
- Correcting Black Line 8-40
- Counting the Number of Pages Printed
  - Counter 2-31
  - Each Job Account 9-46
  - Print Accounting Report 9-47
  - Total Accounting 9-46
  - Unknown ID Job 9-50
- Custom Box
  - Creating a New Box 5-43
  - Deleting Documents 5-49
  - Editing and Deleting Custom Box 5-45
  - Editing Documents 5-48
  - Printing Documents 5-47
  - Storing Documents 5-46

## D

- Data Sanitization 8-36
- Data Security 8-36
- Data Security Kit 11-9
- Date Format 8-37
- Date/Time 8-37

- Date/Timer/Energy Saver 8-37
  - Auto Error Clear 8-39
  - Auto Panel Reset 8-37
  - Date Format 8-37
  - Date/Time 8-37
  - Error Clear Timer 8-39
  - Low Power Timer 8-37
  - Panel Reset Timer 8-37
  - Power Off Rule 8-39
  - Power Off Timer 8-39
  - Sleep Level 8-38
  - Sleep Rules 8-38
  - Sleep Timer 8-38
  - Time Zone 8-37
  - Unusable Time 8-39
- Default Gateway 11-28
  - Settings 8-27
- Default Screen 8-11
- Delete after Printed 6-28
- Density 6-11
- Density Adjustment 8-40
- Destination
  - Adding a Destination 3-35
  - Address Book 5-22
  - Checking and Editing 5-30
  - Confirmation Screen of Destinations 5-31
  - Dest. Check before Send 8-21
  - Entering a New E-mail Address 5-25
  - Entry Check for New Dest. 8-21
  - Multi Sending 5-33
  - One Touch Key 3-41
  - Search 5-23
  - Sort 8-24
  - Specifying a New PC Folder 5-26
- Device 7-13
- DHCP 11-28
  - Settings 8-27
- DHCP (IPv6) 11-28
  - Settings 8-28
- Display Brightness 8-40
- Display Status/Log 8-19
- Document Box
  - Basic Operation 5-42
  - Custom Box 5-41, 5-43
  - Job Box 4-8, 5-41
  - Removable Memory Box 5-42
  - What is Document Box? 5-41
- Document Box Settings 8-22
  - Custom Box 8-22
  - Job Box 8-22
  - Polling Box 8-22
  - Sub Address Box 8-22
- Document Processor
  - How to Load Originals 5-3
  - Loading Originals 5-3
  - Originals Not Supported by the Document Processor 5-3
  - Originals Supported by the Document Processor 5-3
  - Part Names 2-2
- dpi 11-29
- Drum Refresh 8-41
- Duplex 6-18
- Duplex (2-sided Original) 6-22
- Duplex Cover 2-3
- E**
- EcoPrint 6-12, 11-29
  - Default 8-16
  - Printer 8-25
- Edit Destination
  - Address Book 8-23
  - Address Book Defaults 8-24
  - Contact 3-35
  - Group 3-38
  - One Touch Key 3-41
- E-mail Settings 2-41
- E-mail Subject/Body 6-27
  - Default 8-16
- Emulation 11-29
  - Selection 8-25
- Encrypted PDF Password 6-29
- Energy Saving Control Function 1-17
- Energy Star (ENERGY STAR®) Program 1-18
- Enhanced WSD 8-30
- Enhanced WSD (SSL) 8-30
- Enter key 3-10
- Entry
  - File Name 6-21
  - Subject 6-27
- Envelope Lever 2-3
- Environment 1-3
- Error Clear Timer 8-39
- Error Handling 8-17
- Expansion Memory 11-4
- F**
- Favorites 5-5
  - Editing and Deleting 5-10
  - Recalling 5-9
  - Registering 5-6
- FAX 8-22
- File
  - Format 6-24
  - PDF 6-25
  - Separation 6-27
- File Format 6-24
  - Default 8-15
- File Name Entry 6-21
  - Default 8-16
- File Separation 6-27
  - Default 8-15
- First Copy Time 11-25
- First Print Time 11-25
- FMU Connection 5-39
- Format SD Card 8-19
- Format SSD 8-18
- Front Cover 2-2
- Front Cover Open Button 2-2
- FTP 11-29

---

FTP Client (Transmission)  
  Protocol Detail 8-29  
FTP Encrypted TX 6-28  
  Default 8-16  
FTP Server (Reception)  
  Protocol Detail 8-29  
Function Defaults 8-15  
Function Key Usage 8-19  
Fuser Cover 2-3

## G

Glossary 11-28  
GPL/LGPL 1-12  
Grayscale 11-29  
Group Authorization Set. 9-20  
  Group Authorization 9-20  
  Group List 9-21  
Guides Provided with the Machine [xiii](#)

## H

Handle 2-2  
Help 3-11, 11-29  
High-Compression PDF 6-24  
  Default 8-17  
Home 8-19  
  Customize Desktop 3-5  
  Customize Taskbar 3-5  
  Wallpaper 3-5  
Home Screen 3-4  
Host Name 8-27  
HTTP  
  Protocol Detail 8-29  
HTTPS  
  Protocol Detail 8-29

## I

Image Quality 6-24  
  Default 8-17  
Inner Tray 2-2  
Install  
  Macintosh 2-27  
  Software 2-20  
  Windows 2-21  
Interface Block 8-34  
Internet 8-23  
  Proxy 8-23, 8-32  
IP Address 11-29  
  Settings 8-27  
IPP 11-29  
  Protocol Detail 8-29  
IPP over SSL  
  Protocol Detail 8-29  
IPSec  
  Setup 8-31

## J

Job  
  Available Status 7-2  
  Canceling 7-12  
  Checking History 7-9  
  Checking Status 7-2  
  Detailed Information 7-8  
  Detailed Information of Histories 7-11  
  Details of the Status Screens 7-4  
  Displaying History Screen 7-10  
  Displaying Status Screens 7-3  
  Pause and Resumption 7-12  
  Sending the Log History 7-11  
Job Accounting  
  Adding an Account 9-35  
  Counting the Number of Pages Printed 9-46  
  Default Setting 9-45  
  Deleting an Account 9-40  
  Editing an Account 9-38  
  Enabling Job Accounting 9-33  
  FAX Driver 9-44  
  Job Accounting Access 9-34  
  Login 9-49  
  Logout 9-49  
  Overview of Job Accounting 9-32  
  Print Accounting Report 9-47  
  Printing 9-41  
  Restricting the Use of the Machine 9-37  
  TWAIN 9-42  
  WIA 9-43  
Job Box  
  Deletion of Job Retention 8-22  
  Private Print Box 4-8  
  Proof and Hold Box 4-17  
  Quick Copy Box 4-14  
  Quick Copy Job Retention 8-22  
  Specifying the Job Box from a Computer and Storing  
    the Job 4-8  
  Storage Media 8-22  
  Stored Job Box 4-11  
Job Finish Notice 6-20  
JPEG/TIFF Print 6-30  
  Default 8-16

## K

Keyboard Layout 8-18  
KIR 8-26  
Knopflerfish License 1-14  
KPD L 11-29

## L

Label 11-20  
LAN Cable 2-5  
  Connecting 2-6  
LAN Interface 8-31  
Language 8-6  
LDAP  
  Protocol Detail 8-29  
Left Cover 2-4  
Legal Information 1-11



- Legal Restriction on Copying 1-10
- Legal Restriction on Scanning 1-10
- LINE Connector 2-3
- Loading Originals
  - Loading Originals in the Document Processor 5-3
  - Placing Originals on the Platen 5-2
- Local Authorization 9-19
- Login 2-9
- Logout 2-10
- Low Power Mode 2-14
- Low Power Timer 8-37
- Low Toner Alert Level 8-18
- LPD
  - Protocol Detail 8-29

## M

- Management 9-1
- Manual Setting (IPv6) 8-28
- Measurement 8-17
- Media Type Setting 8-14
- Monotype Imaging License Agreement 1-13
- Multi Purpose Tray 2-3, 11-29
  - Paper Size and Media Type 3-23, 8-10
- Multi Sending 5-33

## N

- NetBEUI 11-29
  - Protocol Detail 8-29
- Network
  - Preparation 2-13
  - Settings 8-27
- Network Interface 2-5
- Network Interface (Send) 8-34
- Network Interface Connector 2-3
- Network Interface Kit 11-9
- New E-mail Address 5-25
- New PC Folder 5-26

## O

- One Touch Key
  - Adding 3-41
  - Editing and Deleting 3-42
- OpenSSL License 1-12
- Operation Panel 2-2
- Option
  - Card Authentication Kit 11-3
  - Data Security Kit 11-9
  - Expansion Memory 11-4
  - Network Interface Kit 11-9
  - Overview 11-2
  - Paper Feeder 11-3
  - Rear Tray 11-3
  - SD Card 11-5
  - SSD 11-7
  - ThinPrint Option 11-9
  - USB Keyboard 11-9
  - Wireless Network Interface Kit 11-9
- Option Interface 2-3
- Optional Applications 11-10

- Optional Function 8-37
- Optional Memory 8-36
- Optional Network
  - Basic 8-32
  - Wireless Network 8-33
- Original
  - Custom Original Size 8-12
  - Default Original Size 8-12
  - Settings 8-12
- Original eject table 2-2
- Original Image 6-11
  - Default 8-15
- Original Orientation 6-10
  - Default 8-15
- Original Settings 8-12
- Original Size 6-8
- Original Size Indicator Plates 2-2
- Original SSLeay License 1-12
- Original Stopper 2-2, 5-4
- Original Table 2-2
- Original Width Guides 2-2

## P

- Panel Reset Timer 8-37
- Paper
  - Checking the Remaining Amount of Paper 7-15
  - Appropriate Paper 11-16
  - Cassette 8-9
  - Custom Paper Size 8-13
  - Default Paper Source 8-14
  - Loading Cardstock 3-20
  - Loading Envelopes 3-20
  - Loading Paper 3-12
  - Loading Paper in the Cassettes 3-14
  - Loading Paper in the Multi Purpose Tray 3-18
  - Media for Auto 8-14
  - Media Type Setting 8-14
  - Multi Purpose Tray 8-10
  - Paper Settings 8-13
  - Precaution for Loading Paper 3-13
  - Size and Media Type 3-22, 8-9, 11-15
  - Special Paper 11-19
  - Special Paper Action 8-14
  - Specifications 11-15
  - Weight 8-14
- Paper Feed Mode 8-26
- Paper Feeder 11-3
- Paper Jams 10-26
  - Cassettes 1 to 5 10-28
  - Document Processor 10-32
  - Duplex Unit 10-29
  - Inner Tray 10-31
  - Inside Rear Cover 10-31
  - Inside the Machine 10-30
  - Jam Location Indicators 10-26
  - Multi Purpose Tray 10-27
- Paper Length Guide 2-3, 3-15
- Paper Selection 6-9
- Paper Settings 8-13
- Paper Stopper 2-2, 2-4, 3-24



- Paper Width Guides [2-3, 3-14](#)
- Part Names [2-2](#)
- PDF/A [6-24, 11-30](#)
  - Default [8-17](#)
- Platen [2-2](#)
- POP3 [11-30](#)
- POP3 (E-mail RX)
  - Protocol Detail [8-29](#)
- PostScript [11-30](#)
- Power Cable
  - Connecting [2-7](#)
- Power Management [1-17](#)
- Power Off [2-8](#)
- Power Off Rule [8-39](#)
- Power Off Timer [8-39](#)
- Power On [2-8](#)
- Power Switch [2-2](#)
- PPM [11-30](#)
- Precaution for Loading Paper [3-13](#)
- Precautions for Use [1-4](#)
- Preset Limit [8-17](#)
- Prevent Bleed-thru [6-14](#)
  - Default [8-16](#)
- Print Density [8-40](#)
- Print Settings [4-5](#)
- Printer [8-25](#)
  - Auto Cassette Change [8-26](#)
  - Copies [8-25](#)
  - CR Action [8-26](#)
  - Duplex [8-25](#)
  - EcoPrint [8-25](#)
  - Emulation [8-25](#)
  - Form Feed TimeOut [8-25](#)
  - Job Name [8-26](#)
  - KIR [8-26](#)
  - LF Action [8-26](#)
  - MP Tray Priority [8-26](#)
  - Orientation [8-25](#)
  - Override A4/Letter [8-25](#)
  - Paper Feed Mode [8-26](#)
  - Paper Output [8-25](#)
  - Print setting [4-5](#)
  - Printing from PC [4-2](#)
  - Resolution [8-26](#)
  - User Name [8-26](#)
  - Wide A4 [8-25](#)
- Printer Driver [11-30](#)
  - Help [4-6](#)
- Printing from PC [4-2](#)
- Printing Speed [11-25](#)
- Priority Override [6-21](#)
- Product Library [xiii](#)

## Q

- Quick No. Search key [3-10](#)
- Quick Setup Wizard [2-17](#)
- Quiet Mode [6-21](#)
- Quiet Mode Settings [8-40](#)

## R

- RA (Stateless) [11-30](#)
  - Settings [8-28](#)
- RAM Disk Setting [8-35](#)
- Raw Port
  - Protocol Detail [8-29](#)
- Rear Cover [2-2](#)
- Rear Tray [2-4, 11-3](#)
- Recycled Paper [11-22](#)
- Regarding Trade Names [1-11](#)
- Registration Roller [2-4](#)
- Regular Maintenance [10-2](#)
  - Toner Container Replacement [10-5](#)
  - Waste Toner Box Replacement [10-8](#)
- Remaining amount of toner [7-15](#)
- Report
  - Admin Report Settings [8-7](#)
  - Report Print [8-6](#)
  - Result Report Settings [8-8](#)
  - Sending Log History [8-8](#)
- Report Print [8-6](#)
  - Accounting Report [8-7](#)
  - Font List [8-6](#)
  - Network Status [8-7](#)
  - Optional Network Status [8-7](#)
  - Service Status [8-7](#)
  - Status Page [8-6](#)
- Reserve Next [5-17](#)
- Resolution [6-27, 11-25](#)
- Responding to Messages [10-15](#)
- Restart [8-35](#)
- Restart Network [8-31](#)

## S

- Safety Conventions in This Guide [1-2](#)
- Scan Resolution [6-27](#)
  - Default [8-15](#)
- SD Card [11-5](#)
  - Format [8-19](#)
- Secure Protocol [8-31](#)
- Security Level [8-35](#)
- Send and Forward [8-21](#)
- Send as E-mail [5-19](#)
- Send Result Report [8-8](#)
- Send Settings [8-21](#)
  - Color TIFF Compression [8-21](#)
  - Default Screen [8-21](#)
  - Dest. Check before Send [8-21](#)
  - Entry Check for New Dest. [8-21](#)
  - New Destination Entry [8-21](#)
  - Recall Destination [8-21](#)
  - Send and Forward [8-21](#)
- Send to Folder (FTP) [5-19](#)
- Send to Folder (SMB) [5-19](#)
- Sending [5-19](#)
  - Preparation for Sending a Document to a PC [3-25](#)
- Sending Size [6-23](#)
- Setting Date and Time [2-11](#)
- Sharpness [6-13](#)

- Shortcuts
  - Adding [5-14](#)
  - Editing and Deleting Shortcuts [5-15](#)
- Simple Login [2-10](#)
- Simple Login Settings
  - Simple Login [9-25](#)
  - Simple Login Setup [9-26](#)
- Size Dial [2-3](#)
- Sleep [2-15](#)
- Sleep Level [2-16, 8-38](#)
- Sleep Rules [2-15, 8-38](#)
- Sleep Timer [8-38](#)
- Slit Glass [2-2](#)
- SMB Client (Transmission)
  - Protocol Detail [8-29](#)
- SMTP [11-30](#)
- SMTP (E-mail TX)
  - Protocol Detail [8-29](#)
- SNMP
  - Protocol Detail [8-29](#)
- SNMPv3
  - Protocol Detail [8-29](#)
- Solving Malfunctions [10-10](#)
- Sound [8-11](#)
- Specifications [11-23](#)
  - Common Functions [11-23](#)
  - Copy Functions [11-25](#)
  - Document Processor [11-26](#)
  - Paper Feeder (500-sheet) (Option) [11-27](#)
  - Printer Functions [11-25](#)
  - Scanner Functions [11-26](#)
- Specifying Destination [5-22](#)
- SSD [11-7](#)
  - Format [8-18](#)
- SSD Initialization [8-36](#)
- SSL [8-31](#)
- Status Page [11-30](#)
- Status/Job Cancel [7-1](#)
- Storing Size [6-29](#)
- Subnet Mask [11-30](#)
  - Settings [8-27](#)
- Supplies
  - Checking the Remaining Amount [7-15](#)
- Support Tray Section of the Multi Purpose Tray [2-3](#)
- Symbols [1-2](#)

- System Menu [8-2](#)
  - Address Book/One Touch [8-23](#)
  - Adjustment/Maintenance [8-40](#)
  - Application [8-23](#)
  - Cassette/MP Tray Settings [8-9](#)
  - Common Settings [8-11](#)
  - Copy [8-20](#)
  - Date/Timer/Energy Saver [8-37](#)
  - Document Box [8-22](#)
  - FAX [8-22](#)
  - Home [3-4](#)
  - Internet [8-23](#)
  - Language [8-6](#)
  - Operation Method [8-2](#)
  - Printer [8-25](#)
  - Quick Setup Wizard [2-17](#)
  - Report [8-6](#)
  - Send [8-21](#)
  - System/Network [8-27](#)
  - User Login/Job Accounting [8-24, 9-2](#)
  - User Property [9-11](#)
- System/Network [8-27](#)
  - Data Security [8-36](#)
  - Interface Block [8-34](#)
  - Network [8-27](#)
  - Network Interface (Send) [8-34](#)
  - Optional Function [8-37](#)
  - Optional Memory [8-36](#)
  - Optional Network [8-32](#)
  - RAM Disk Setting [8-35](#)
  - Restart [8-35](#)
  - Security Level [8-35](#)

## T

- TCP/IP [11-31](#)
  - Settings [8-27](#)
- TCP/IP (IPv4)
  - Settings [8-27](#)
  - Setup [2-13](#)
- TCP/IP (IPv6) [11-28](#)
  - Settings [8-28](#)
- TEL Connector [2-3](#)
- ThinPrint
  - Protocol Detail [8-30](#)
- ThinPrint Option [11-9](#)
- ThinPrint Over SSL
  - Protocol Detail [8-30](#)
- Time Zone [8-37](#)
- Toner Container (Black) [2-4](#)
- Toner Container Lock Lever [2-4](#)
- Toner Container Replacement [10-5](#)
- Touch Panel [3-4](#)
- Troubleshooting [10-10](#)
- TWAIN [11-31](#)
  - Scanning using TWAIN [5-37](#)
  - Setting TWAIN Driver [2-29](#)

## U

- USB [11-31](#)

---

- USB Cable
  - Connecting [2-7](#)
- USB Interface [2-5](#)
- USB Interface Connector [2-3](#)
- USB Keyboard [11-9](#)
- USB Keyboard Type [8-18](#)
- USB Memory
  - Printing [5-50](#)
  - Remove [5-54](#)
  - Save [5-52](#)
- USB Memory Slot [2-2](#)
- User Login Administration [9-2](#)
  - Adding a User [9-5](#)
  - Changing User Properties [9-9](#)
  - Enabling User Login Administration [9-3](#)
  - FAX Driver [9-18](#)
  - Group Authorization Set. [9-20](#)
  - ID Card Settings [9-29](#)
  - Local Authentication [9-19](#)
  - Login [2-9](#)
  - Logout [2-10](#)
  - Obtain NW User Property [9-23](#)
  - Overview of User Login Administration [9-2](#)
  - Printing [9-15](#)
  - Simple Login Settings [9-25](#)
  - TWAIN [9-16](#)
  - User Account Lockout Setting [9-13](#)
  - WIA [9-17](#)
- User Login/Job Accounting
  - Job Accounting [9-32](#)
  - Unknown ID Job [9-50](#)
  - User Login [9-2](#)
- User Property [8-9](#)

## W

- Waste Toner Box [2-4](#)
- Waste Toner Box Replacement [10-8](#)
- WIA [11-31](#)
  - Setting WIA Driver [2-30](#)
- Wireless Network Interface Kit [11-9](#)
- WSD Print
  - Setup [8-30](#)
- WSD Scan
  - Setup [8-30](#)

## X

- XPS Fit to Page [6-30](#)
  - Default [8-16](#)

## Z

- Zoom [6-14](#)
  - Default [8-16](#)

**QUALITY  
CERTIFICATE**

This machine has passed  
all quality controls and  
final inspection.

**KYOCERA Document Solutions America, Inc.****Headquarters**

225 Sand Road,  
Fairfield, New Jersey 07004-0008, USA  
Phone: +1-973-808-8444  
Fax: +1-973-882-6000

**Latin America**

8240 NW 52nd Terrace Dawson Building, Suite 100  
Miami, Florida 33166, USA  
Phone: +1-305-421-6640  
Fax: +1-305-421-6666

**KYOCERA Document Solutions Canada, Ltd.**

6120 Kestrel Rd., Mississauga, ON L5T 1S8,  
Canada  
Phone: +1-905-670-4425  
Fax: +1-905-670-8116

**KYOCERA Document Solutions  
Mexico, S.A. de C.V.**

Calle Arquimedes No. 130, 4 Piso, Colonia Polanco  
Chapultepec, Delegacion Miguel Hidalgo,  
Distrito Federal, C.P. 11560, México  
Phone: +52-555-383-2741  
Fax: +52-555-383-7804

**KYOCERA Document Solutions Brazil, Ltda.**

Alameda África, 545, Pólo Empresarial Consbrás,  
Tamboré, Santana de Parnaíba-SP, CEP 06543-306,  
Brazil  
Phone: +55-11-4195-8496  
Fax: +55-11-4195-6167

**KYOCERA Document Solutions  
Australia Pty. Ltd.**

Level 3, 6-10 Talavera Road North Ryde N.S.W, 2113,  
Australia  
Phone: +61-2-9888-9999  
Fax: +61-2-9888-9588

**KYOCERA Document Solutions  
New Zealand Ltd.**

Ground Floor, 19 Byron Avenue, Takapuna, Auckland,  
New Zealand  
Phone: +64-9-415-4517  
Fax: +64-9-415-4597

**KYOCERA Document Solutions Asia Limited**

16/F., Mita Centre, 552-566, Castle Peak Road  
Tsuenwan, NT, Hong Kong  
Phone: +852-2610-2181  
Fax: +852-2610-2063

**KYOCERA Document Solutions  
(China) Corporation**

8F, No. 288 Nanjing Road West, Huangpu District,  
Shanghai, 200003, China  
Phone: +86-21-5301-1777  
Fax: +86-21-5302-8300

**KYOCERA Document Solutions  
(Thailand) Corp., Ltd.**

335 Ratchadapisek Road, Bangsue, Bangkok 10800,  
Thailand  
Phone: +66-2-586-0333  
Fax: +66-2-586-0278

**KYOCERA Document Solutions  
Singapore Pte. Ltd.**

12 Tai Seng Street #04-01A,  
Luxasia Building, Singapore 534118  
Phone: +65-6741-8733  
Fax: +65-6748-3788

**KYOCERA Document Solutions  
Hong Kong Limited**

16/F., Mita Centre, 552-566, Castle Peak Road  
Tsuenwan, NT, Hong Kong  
Phone: +852-3582-4000  
Fax: +852-3185-1399

**KYOCERA Document Solutions  
Taiwan Corporation**

6F., No.37, Sec. 3, Minquan E. Rd.,  
Zhongshan Dist., Taipei 104, Taiwan R.O.C.  
Phone: +886-2-2507-6709  
Fax: +886-2-2507-8432

**KYOCERA Document Solutions Korea Co., Ltd.**

18F, Kangnam bldg, 1321-1,  
Seocho-Dong, Seocho-Gu, Seoul, Korea  
Phone: +822-6933-4050  
Fax: +822-747-0084

**KYOCERA Document Solutions  
India Private Limited**

First Floor, ORCHID CENTRE  
Sector-53, Golf Course Road, Gurgaon 122 002,  
India  
Phone: +91-0124-4671000  
Fax: +91-0124-4671001

**KYOCERA Document Solutions Europe B.V.**

Bloemlaan 4, 2132 NP Hoofddorp,  
The Netherlands  
Phone: +31-20-654-0000  
Fax: +31-20-653-1256

**KYOCERA Document Solutions Nederland B.V.**

Beechavenue 25, 1119 RA Schiphol-Rijk,  
The Netherlands  
Phone: +31-20-5877200  
Fax: +31-20-5877260

**KYOCERA Document Solutions (U.K.) Limited**

Eldon Court, 75-77 London Road,  
Reading, Berkshire RG1 5BS,  
United Kingdom  
Phone: +44-118-931-1500  
Fax: +44-118-931-1108

**KYOCERA Document Solutions Italia S.p.A.**

Via Verdi, 89/91 20063 Cernusco s/N.(MI),  
Italy  
Phone: +39-02-921791  
Fax: +39-02-92179-600

**KYOCERA Document Solutions Belgium N.V.**

Sint-Martinusweg 199-201 1930 Zaventem,  
Belgium  
Phone: +32-2-7209270  
Fax: +32-2-7208748

**KYOCERA Document Solutions France S.A.S.**

Espace Technologique de St Aubin  
Route de l'Orme 91195 Gif-sur-Yvette CEDEX,  
France  
Phone: +33-1-69852600  
Fax: +33-1-69853409

**KYOCERA Document Solutions Espana, S.A.**

Edificio Kyocera, Avda. de Manacor No.2,  
28290 Las Matas (Madrid), Spain  
Phone: +34-91-6318392  
Fax: +34-91-6318219

**KYOCERA Document Solutions Finland Oy**

Atomitie 5C, 00370 Helsinki,  
Finland  
Phone: +358-9-47805200  
Fax: +358-9-47805390

**KYOCERA Document Solutions  
Europe B.V., Amsterdam (NL) Zürich Branch**

Hohlstrasse 614, 8048 Zürich,  
Switzerland  
Phone: +41-44-9084949  
Fax: +41-44-9084950

**KYOCERA Document Solutions  
Deutschland GmbH**

Otto-Hahn-Strasse 12, 40670 Meerbusch,  
Germany  
Phone: +49-2159-9180  
Fax: +49-2159-918100

**KYOCERA Document Solutions Austria GmbH**

Eduard-Kittenberger-Gasse 95, 1230 Vienna,  
Austria  
Phone: +43-1-863380  
Fax: +43-1-86338-400

**KYOCERA Document Solutions Nordic AB**

Esbogatan 16B 164 75 Kista, Sweden  
Phone: +46-8-546-550-00  
Fax: +46-8-546-550-10

**KYOCERA Document Solutions Norge Nuf**

Postboks 150 Oppsal, 0619 Oslo,  
Norway  
Phone: +47-22-62-73-00  
Fax: +47-22-62-72-00

**KYOCERA Document Solutions Danmark A/S**

Ejby Industrivej 60, DK-2600 Glostrup,  
Denmark  
Phone: +45-70223880  
Fax: +45-45765850

**KYOCERA Document Solutions Portugal Lda.**

Rua do Centro Cultural, 41 (Alvalade) 1700-106 Lisboa,  
Portugal  
Phone: +351-21-843-6780  
Fax: +351-21-849-3312

**KYOCERA Document Solutions  
South Africa (Pty) Ltd.**

KYOCERA House, Hertford Office Park,  
90 Bekker Road (Cnr. Allandale), Midrand, South Africa.  
Phone: +27-11-540-2600  
Fax: +27-11-466-3050

**KYOCERA Document Solutions Russia LLC**

Botanichesky pereulok 5, Moscow, 129090,  
Russia  
Phone: +7(495)741-0004  
Fax: +7(495)741-0018

**KYOCERA Document Solutions Middle East**

Dubai Internet City, Bldg. 17,  
Office 157 P.O. Box 500817, Dubai,  
United Arab Emirates  
Phone: +971-04-433-0412

**KYOCERA Document Solutions Inc.**

2-28, 1-chome, Tamatsukuri, Chuo-ku  
Osaka 540-8585, Japan  
Phone: +81-6-6764-3555  
<http://www.kyoceradocumentsolutions.com>

