



DS-570W

User's Guide

Copyright

Copyright

No part of this publication may be reproduced, stored in a retrieval system, or transmitted in any form or by any means, electronic, mechanical, photocopying, recording, or otherwise, without the prior written permission of Seiko Epson Corporation. No patent liability is assumed with respect to the use of the information contained herein. Neither is any liability assumed for damages resulting from the use of the information herein. The information contained herein is designed only for use with this Epson product. Epson is not responsible for any use of this information as applied to other products.

Neither Seiko Epson Corporation nor its affiliates shall be liable to the purchaser of this product or third parties for damages, losses, costs, or expenses incurred by the purchaser or third parties as a result of accident, misuse, or abuse of this product or unauthorized modifications, repairs, or alterations to this product, or (excluding the U.S.) failure to strictly comply with Seiko Epson Corporation's operating and maintenance instructions.

Seiko Epson Corporation and its affiliates shall not be liable for any damages or problems arising from the use of any options or any consumable products other than those designated as Original Epson Products or Epson Approved Products by Seiko Epson Corporation.

Seiko Epson Corporation shall not be held liable for any damage resulting from electromagnetic interference that occurs from the use of any interface cables other than those designated as Epson Approved Products by Seiko Epson Corporation.

© 2016 Seiko Epson Corporation. All rights reserved.

The contents of this manual and the specifications of this product are subject to change without notice.

Trademarks

- ❑ EPSON® is a registered trademark, and EPSON EXCEED YOUR VISION or EXCEED YOUR VISION is a trademark of the Seiko Epson Corporation.
- ❑ Microsoft®, Windows®, Windows Server®, and Windows Vista® are either registered trademarks or trademarks of Microsoft Corporation in the United States and/or other countries.
- ❑ Apple®, Mac OS®, and OS X® are trademarks of Apple Inc., registered in the U.S. and other countries.
- ❑ Adobe®, Adobe Reader®, and Acrobat® are registered trademarks of Adobe Systems Incorporated.
- ❑ Intel® is a registered trademark of Intel Corporation.
- ❑ Wi-Fi®, Wi-Fi Alliance®, and Wi-Fi Protected Access® (WPA) are registered trademarks of the Wi-Fi Alliance. Wi-Fi Protected Setup™, and WPA2™ are trademarks of the Wi-Fi Alliance.
- ❑ The SuperSpeed USB Trident Logo is a registered trademark of USB Implementers Forum, Inc.
- ❑ Epson Scan 2 Software is based in part on the work of the Independent JPEG Group.
- ❑ libtiff

Copyright © 1988-1997 Sam Leffler

Copyright © 1991-1997 Silicon Graphics, Inc.

Permission to use, copy, modify, distribute, and sell this software and its documentation for any purpose is hereby granted without fee, provided that (i) the above copyright notices and this permission notice appear in all copies of the software and related documentation, and (ii) the names of Sam Leffler and Silicon Graphics may not be used in any advertising or publicity relating to the software without the specific, prior written permission of Sam Leffler and Silicon Graphics.

THE SOFTWARE IS PROVIDED "AS-IS" AND WITHOUT WARRANTY OF ANY KIND, EXPRESS, IMPLIED OR OTHERWISE, INCLUDING WITHOUT LIMITATION, ANY WARRANTY OF MERCHANTABILITY OR FITNESS FOR A PARTICULAR PURPOSE.

IN NO EVENT SHALL SAM LEFFLER OR SILICON GRAPHICS BE LIABLE FOR ANY SPECIAL, INCIDENTAL, INDIRECT OR CONSEQUENTIAL DAMAGES OF ANY KIND, OR ANY DAMAGES WHATSOEVER RESULTING FROM LOSS OF USE, DATA OR PROFITS, WHETHER OR NOT ADVISED OF THE POSSIBILITY OF DAMAGE, AND ON ANY THEORY OF LIABILITY, ARISING OUT OF OR IN CONNECTION WITH THE USE OR PERFORMANCE OF THIS SOFTWARE.

- ❑ General Notice: Other product names used herein are for identification purposes only and may be trademarks of their respective owners. Epson disclaims any and all rights in those marks.

Contents

Copyright

Trademarks

About This Manual

Introducing the Manuals.	7
Marks and Symbols.	7
Descriptions Used in this Manual.	7
Operating System References.	8

Important Instructions

Safety Instructions.	9
Restrictions on Copying.	10

Scanner Basics

Part Names and Functions.	11
Buttons and Lights on the Control Panel.	13
Buttons.	13
Lights.	14
Error Indicators.	15
Information on Applications.	16
Epson Scan 2.	16
Document Capture Pro / Document Capture.	17
Presto! BizCard.	17
EPSON Software Updater.	17
Epson DocumentScan.	17
EpsonNet Config.	17
Web Config.	17
Option Items and Consumables Information.	18
Network Interface Unit Codes.	18
Carrier Sheet Codes.	18
Roller Assembly Kit Codes.	19
Cleaning Kit Codes.	20

Specifications of Originals and Placing Originals

Specifications of Originals.	21
General Specifications for Originals being Scanned.	21
Types of Originals that Require Attention.	24
Types of Originals that Must Not be Scanned.	24
Placing Originals.	25
Standard Size Originals.	25

Long Paper.	31
Plastic Cards.	33
Laminated Cards.	36
Large Size Originals.	39
Irregular Shaped Originals.	41
Photographs.	44
Envelopes.	47
Mixture of Originals.	50

Basic Scanning

Scanning Using Epson Scan 2.	53
Required Settings for Special Originals in Epson Scan 2.	56
Setting a Resolution That Suits the Scanning Purpose.	57
Scanning Using Document Capture Pro (Windows).	57
Scanning Using Document Capture (Mac OS X).	60
Scanning Using a Scanner Button.	62

Advanced Scanning

Scanning Different Sizes or Types of Originals One by One (Automatic Feeding Mode).	64
Creating Scanned Images to Suit Your Needs.	65
Image Adjustment Features.	65
Editing Scanned Pages Using Epson Scan 2.	72
Saving as a Searchable PDF.	72
Saving as an Office Format File (for Windows Only).	73
Various Types of Saving and Transferring.	75
Sorting and Saving Scanned Images into a Separate Folder (for Windows Only).	75
Scanning to a Cloud Service.	75
Uploading to an FTP Server.	77
Attaching Scanned Images to an Email.	77
Printing Scanned Images.	78
Scanning Using Specified Scanning Settings (Job).	78
Setting a Job.	79
Assigning a Job to the Scanner Button.	79
Scanning Business Cards Using Presto! BizCard.	80
Scanning from Smart Devices Using NFC Tag.	81

Network Settings

Network Connection Types.	83
Wi-Fi Connection.	83

Contents

AP Mode Connection.	83
Connecting to a Computer.	84
Connecting to a Smart Device.	86
Making Wi-Fi Settings from the Control Panel.	86
Making Wi-Fi Settings by Push Button Setup (WPS).	86
Making Wi-Fi Settings by PIN Code Setup (WPS).	87
Making AP Mode Settings.	87
Checking the Network Status Using Network Light.	88
Replacing or Adding New Access Points.	88
Changing the Connection Method to a Computer.	88
Disabling the Network Setting from the Control Panel.	89
Restoring the Network Settings from the Control Panel.	90

Maintenance

Cleaning Outside the Scanner.	91
Cleaning Inside the Scanner.	91
Replacing the Roller Assembly Kit.	96
Resetting the Number of Scans.	100
Energy Saving.	101
Transporting the Scanner.	102
Updating Applications and Firmware.	103

Solving Problems

Scanner Problems.	105
Scanner Lights Indicate an Error.	105
The Scanner Does Not Turn On.	105
Problems Starting Scanning.	105
Cannot Start Epson Scan 2.	105
Pressing a Scanner Button Does Not Start the Correct Application.	106
Paper Feeding Problems.	106
Multiple Originals Are Fed.	106
Removing Jammed Originals from the Scanner.	107
The Original Jams in the Scanner Frequently.	108
The Originals Get Dirty.	108
Scanning Speed Slows Down when Scanning Continuously.	109
Scanning Takes a Long Time.	109
Scanned Image Problems.	109
Straight Lines Appear when Scanning from ADF.	109
The Image Quality is Rough.	109

Expanding or Contracting the Scanned Image.	110
Offset Appears in the Background of Images.	110
Text is Blurred.	110
Moiré Patterns (Web-Like Shadows) Appear.	111
The Edge of the Original is Not Scanned when Automatically Detecting the Size of the Original.	111
Text is Not Recognized Correctly when Saving as a Searchable PDF.	111
Cannot Solve Problems in the Scanned Image.	112
Network Problems.	113
When You Cannot Make Network Settings.	113
The Scanner Suddenly Cannot Scan over a Network Connection.	115
The Scanner Suddenly Cannot Scan Using a USB Connection.	116
Uninstalling and Installing Applications.	116
Uninstalling Your Applications.	116
Installing Your Applications.	118

Technical Specifications

General Scanner Specifications.	119
Wi-Fi Specifications.	120
Security Protocol.	120
Dimensional Specifications.	120
Electrical Specifications.	121
Scanner Electrical Specifications.	121
AC Adapter Electrical Specifications.	121
Environmental Specifications.	121
System Requirements.	122

Standards and Approvals

Standards and Approvals for U.S. Models.	123
Standards and Approvals for European Models.	123
Standards and Approvals for Australian Models.	124

Where to Get Help

Technical Support Web Site.	125
Contacting Epson Support.	125
Before Contacting Epson.	125
Help for Users in Europe.	125
Help for Users in Taiwan.	126
Help for Users in Australia.	126
Help for Users in Singapore.	127
Help for Users in Thailand.	127
Help for Users in Vietnam.	127
Help for Users in Indonesia.	128

Contents

Help for Users in Hong Kong.	129
Help for Users in Malaysia.	130
Help for Users in India.	130
Help for Users in the Philippines.	131

About This Manual

Introducing the Manuals

The latest versions of the following manuals are available from the Epson support website.

<http://www.epson.eu/Support> (Europe)

<http://support.epson.net/> (outside Europe)

Setup Guide (paper manual)

Provides you with information on setting up the product and installing the application.

User's Guide (digital manual)

Provides instructions on using the product, maintenance, and solving problems.

Administrator's Guide (digital manual)

Provides network administrators with information on management and scanner settings.

As well as the manuals above, see the help included in the various Epson applications.

Marks and Symbols



Caution:

Instructions that must be followed carefully to avoid bodily injury.



Important:

Instructions that must be observed to avoid damage to your equipment.

Note:

Provides complementary and reference information.

Related Information

➔ Links to related sections.

Descriptions Used in this Manual

Screenshots for the applications are from Windows 10 or Mac OS X v10.10.x. The content displayed on the screens varies depending on the model and situation.

Illustrations used in this manual are for reference only. Although they may differ slightly from the actual product, the operating methods are the same.

Operating System References

Windows

In this manual, terms such as "Windows 10", "Windows 8.1", "Windows 8", "Windows 7", "Windows Vista", "Windows XP", "Windows Server 2012 R2", "Windows Server 2012", "Windows Server 2008 R2", "Windows Server 2008", "Windows Server 2003 R2", and "Windows Server 2003" refer to the following operating systems. Additionally, "Windows" is used to refer to all versions.

- Microsoft® Windows® 10 operating system
- Microsoft® Windows® 8.1 operating system
- Microsoft® Windows® 8 operating system
- Microsoft® Windows® 7 operating system
- Microsoft® Windows Vista® operating system
- Microsoft® Windows® XP operating system Service Pack 3
- Microsoft® Windows® XP Professional x64 Edition operating system Service Pack 2
- Microsoft® Windows Server® 2012 R2 operating system
- Microsoft® Windows Server® 2012 operating system
- Microsoft® Windows Server® 2008 R2 operating system
- Microsoft® Windows Server® 2008 operating system
- Microsoft® Windows Server® 2003 R2 operating system
- Microsoft® Windows Server® 2003 operating system Service Pack 2

Mac OS X

In this manual, "Mac OS X v10.11.x" refers to OS X El Capitan, "Mac OS X v10.10.x" refers to OS X Yosemite, "Mac OS X v10.9.x" refers to OS X Mavericks, and "Mac OS X v10.8.x" refers to OS X Mountain Lion. Additionally, "Mac OS X" is used to refer to "Mac OS X v10.11.x", "Mac OS X v10.10.x", "Mac OS X v10.9.x", "Mac OS X v10.8.x", "Mac OS X v10.7.x", and "Mac OS X v10.6.8".

Important Instructions

Safety Instructions

Read and follow these instructions to ensure safe use of this product and options. Make sure you keep this manual for future reference. Also, be sure to follow all warnings and instructions marked on the product and options.

- ❑ Some of the symbols used on your product and options are to ensure safety and proper use of the product. Visit the following Web site to learn the meaning of the symbols.
<http://support.epson.net/symbols>
- ❑ Place the product and options on a flat, stable surface that extends beyond the base of the product and options in all directions. If you place the product and options by the wall, leave more than 10 cm between the back of the product and options and the wall.
- ❑ Place the product and options close enough to the computer for the interface cable to reach it easily. Do not place or store the product and options or the AC adapter outdoors, near excessive dirt or dust, water, heat sources, or in locations subject to shocks, vibrations, high temperature or humidity, direct sunlight, strong light sources, or rapid changes in temperature or humidity.
- ❑ Do not use with wet hands.
- ❑ Place the product and options near an electrical outlet where the adapter can be easily unplugged.
- ❑ The AC adapter cord should be placed to avoid abrasions, cuts, fraying, crimping, and kinking. Do not place objects on top of the cord and do not allow the AC adapter or the cord to be stepped on or run over. Be particularly careful to keep the cord straight at the end.
- ❑ Use only the power cord supplied with the product and do not use the cord with any other equipment. Use of other cords with this product or the use of the supplied power cord with other equipment may result in fire or electric shock.
- ❑ Use only the AC adapter that comes with your product. Using any other adapter could cause fire, electrical shock, or injury.
- ❑ The AC adapter is designed for use with the product with which it was included. Do not attempt to use it with other electronic devices unless specified.
- ❑ Use only the type of power source indicated on the AC adapter's label, and always supply power directly from a standard domestic electrical outlet with the AC adapter that meets the relevant local safety standards.
- ❑ When connecting this product and options to a computer or other device with a cable, ensure the correct orientation of the connectors. Each connector has only one correct orientation. Inserting a connector in the wrong orientation may damage both devices connected by the cable.
- ❑ Avoid using outlets on the same circuit as photocopiers or air control systems that regularly switch on and off.
- ❑ If you use an extension cord with the product, make sure the total ampere rating of the devices plugged into the extension cord does not exceed the cord's ampere rating. Also, make sure the total ampere rating of all devices plugged into the wall outlet does not exceed the wall outlet's ampere rating.
- ❑ Never disassemble, modify, or attempt to repair the AC adapter, product, or product options by yourself except as specifically explained in the product's guides.
- ❑ Do not insert objects into any opening as they may touch dangerous voltage points or short out parts. Beware of electrical shock hazards.
- ❑ If damage occurs to the plug, replace the cord set or consult a qualified electrician. If there are fuses in the plug, make sure you replace them with fuses of the correct size and rating.

Important Instructions

- ❑ Unplug the product, options, and the AC adapter, and refer servicing to qualified service personnel under the following conditions: The AC adapter or plug is damaged; liquid has entered the product, options, or the AC adapter; the product or the AC adapter has been dropped or the case has been damaged; the product, options, or the AC adapter does not operate normally or exhibits a distinct change in performance. (Do not adjust controls that are not covered by the operating instructions.)
- ❑ Unplug the product and the AC adapter before cleaning. Clean with a damp cloth only. Do not use liquid or aerosol cleaners except as specifically explained in the product's guides.
- ❑ If you are not going to use the product for a long period, be sure to unplug the AC adapter from the electrical outlet.
- ❑ After replacing consumable parts, dispose of them correctly following the rules of your local authority. Do not disassemble them.
- ❑ Keep this product at least 22 cm away from cardiac pacemakers. Radio waves from this product may adversely affect the operation of cardiac pacemakers.
- ❑ Do not use this product inside medical facilities or near medical equipment. Radio waves from this product may adversely affect the operation of electrical medical equipment.
- ❑ Do not use this product near automatically controlled devices such as automatic doors or fire alarms. Radio waves from this product may adversely affect these devices, and could lead to accidents due to malfunction.

Restrictions on Copying

Observe the following restrictions to ensure the responsible and legal use of your product.

Copying of the following items is prohibited by law:

- ❑ Bank bills, coins, government-issued marketable securities, government bond securities, and municipal securities
- ❑ Unused postage stamps, pre-stamped postcards, and other official postal items bearing valid postage
- ❑ Government-issued revenue stamps, and securities issued according to legal procedure

Exercise caution when copying the following items:

- ❑ Private marketable securities (stock certificates, negotiable notes, checks, etc.), monthly passes, concession tickets, etc.
- ❑ Passports, driver's licenses, warrants of fitness, road passes, food stamps, tickets, etc.

Note:

Copying these items may also be prohibited by law.

Responsible use of copyrighted materials:

Products can be misused by improperly copying copyrighted materials. Unless acting on the advice of a knowledgeable attorney, be responsible and respectful by obtaining the permission of the copyright holder before copying published material.

Scanner Basics

Part Names and Functions

Front

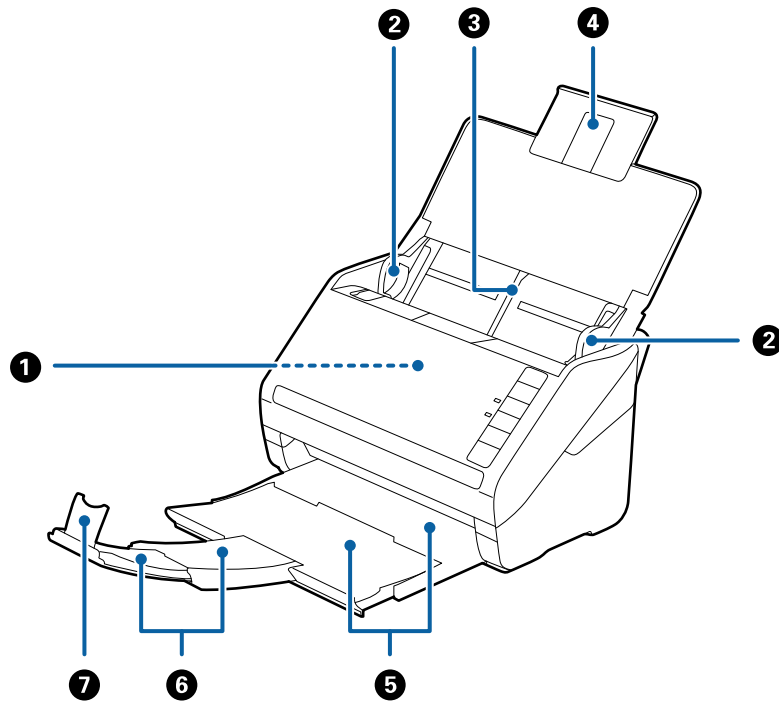

①	ADF (Automatic Document Feeder)	Feeds loaded originals automatically.
②	Edge guides	Feeds originals straight into the scanner. Slide to the edges of the originals.
③	Input tray	Loads originals. Pull out the tray extension if originals are too big for the input tray. This prevents paper from curling and causing paper jams.
④	Input tray extension	
⑤	Output tray	Holds originals ejected from the scanner. Pull out the extension tray to the length of the originals.
⑥	Output tray extension	
⑦	Stopper	Prevents ejected originals from falling off the extension tray. Adjust it to the length of the originals.

Scanner Basics

Back

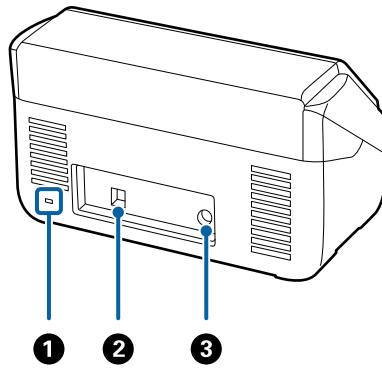

①	Security slot	Inserts a security lock for theft prevention.
②	USB port	Connects a USB cable.
③	DC inlet	Connects the AC adapter.

Inside

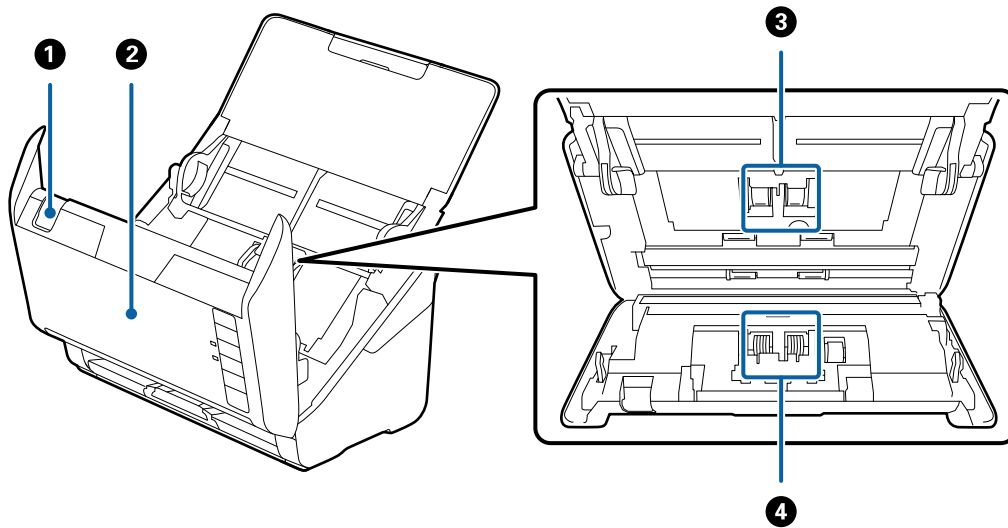

①	Cover open lever	Pull the cover open lever and open the scanner cover.
②	Scanner cover	Pull the cover open lever and open the scanner cover when cleaning inside of the scanner and removing jammed paper.
③	Pickup roller	Feeds originals. This needs to be replaced when the number of scans exceeds the service number of papers.
④	Separation roller	Feeds originals separately one by one. This needs to be replaced when the number of scans exceeds the service number of papers.

Related Information

- ➔ [“Cleaning Inside the Scanner” on page 91](#)
- ➔ [“Replacing the Roller Assembly Kit” on page 96](#)

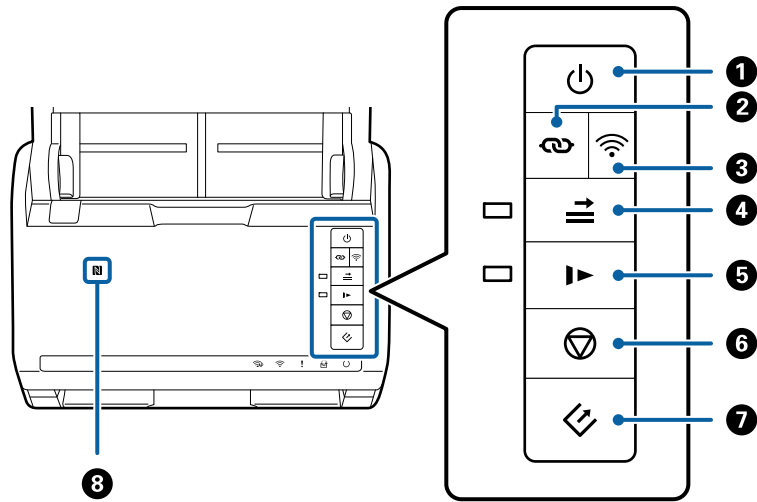

Buttons and Lights on the Control Panel

Buttons







1		Power button	Turns the scanner on or off.
2		Wi-Fi connect button	Press the WPS button on the access point, and then press the button for more than three seconds to connect to a Wi-Fi network. See the chapter "Network Settings" for more details. Press the button to cancel the settings.
3		Wi-Fi on/off button	Press this button for more than three seconds to turn off the wireless signal. Press again to turn on the signal.
4		Double feed detection skip button	Normally, an error occurs when detecting double feeds when loading envelopes, plastic cards, originals with labels or stickers, and so on. Press the button before scanning to skip this error once (one sheet). The light is on when this is enabled. Follow the steps below to restart scanning when a double feed error has occurred (the error light flashes). <ol style="list-style-type: none"> 1. Open the scanner cover, and then remove the originals. 2. Close the scanner cover, and then press the button. 3. Load the originals. 4. Restart scanning by pressing the start button or the software button.
5		Slow mode button	Slow down the feeding speed when scanning. The light is on when this is enabled. Press this button in the following situations: <input type="checkbox"/> when originals jam frequently <input type="checkbox"/> when loading thin originals

Scanner Basics

6		Stop button	<ul style="list-style-type: none"> <input type="checkbox"/> Cancels scanning. <input type="checkbox"/> Finishes Automatic Feeding Mode. <input type="checkbox"/> Cancels Wi-Fi settings by push button setup (WPS). <input type="checkbox"/> Press this to release the error when a network connection error occurs. <input type="checkbox"/> Cancels a firmware update over a network connection.
7		Start button	<ul style="list-style-type: none"> <input type="checkbox"/> Starts scanning. <input type="checkbox"/> Press this when cleaning the inside of the scanner.
8		NFC tag	Hold a smart device over this tag to scan directly from the smart device.

Additional functions are available with different combinations of buttons.

	Hold down the  and  buttons for more than three seconds to start PIN Code Setup (WPS). See the chapter "Network Settings" for more details.
	Turn on the scanner while holding down the  button to restore the default network settings.

Related Information





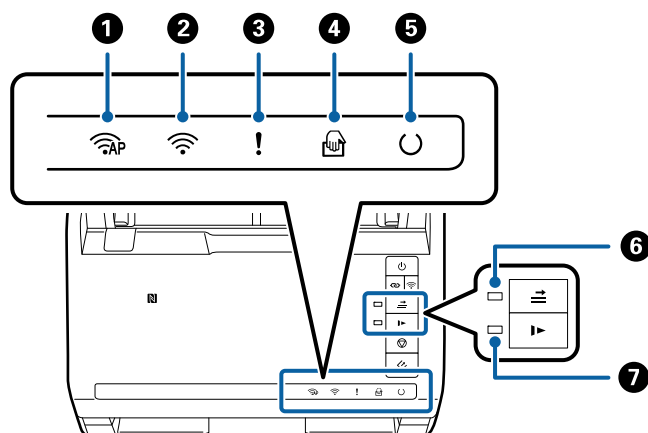

- ➔ ["Network Settings" on page 83](#)
- ➔ ["Placing Plastic Cards" on page 34](#)
- ➔ ["Placing Envelopes" on page 48](#)
- ➔ ["Placing Laminated Cards" on page 37](#)
- ➔ ["Cleaning Inside the Scanner" on page 91](#)
- ➔ ["Scanning from Smart Devices Using NFC Tag" on page 81](#)

Lights



1		AP mode light	Indicates that the scanner is connected wirelessly in AP mode.
---	---	---------------	--

Scanner Basics







2		Wi-Fi light	Blue indicates that the scanner is connected to a wireless (Wi-Fi) network. White indicates it is searching for an access point.	
3		Error light	An error has occurred. See "Light Error Indicators" for more details.	
4		Automatic Feeding Mode light	The scanner is in Automatic Feeding Mode. Scanning starts when an original is placed in the input tray.	
5		Ready light	On:	The scanner is ready to be used.
			Flashing:	The scanner is scanning, waiting to scan, processing, or sleeping.
			Off:	The scanner cannot be used because the power is off or an error has occurred.
6		Skip double feed detection light	This is on when skipping double feed detection is enabled.	
7		Slow mode light	This is on during slow mode.	

Related Information







- ➔ ["Error Indicators" on page 15](#)
- ➔ ["Placing a Mixture of Originals at Different Sizes" on page 51](#)

Error Indicators







Scanner errors

Indicators	Situation	Solutions
 Flashing slowly	A paper jam or double feed occurred.	Open the scanner cover, and then remove jammed originals. Close the cover to release the error. Load the originals again.
 On	The scanner cover is opened.	Close the scanner cover.
 Flashing fast  Flashing fast  Flashing fast  Flashing fast	A fatal error has occurred.	Turn the power off and on again. If the error continues to occur, contact your local dealer.

Scanner Basics

Indicators	Situation	Solutions
 AP On  On  On  On  Off  On  On	The scanner has started in recovery mode because the firmware update failed.	<p>Follow the steps below to try to update the firmware again.</p> <ol style="list-style-type: none"> 1. Connect the computer and the scanner with a USB cable. (During recovery mode, you cannot update the firmware over a network connection.) 2. Visit your local Epson website for further instructions.

Network connection errors

Indicators	Situation	Solutions
 Flashing slowly  On	An access point settings error has occurred.	Press the  button to release the error, and then restart the devices you want to connect to the network. Reconnect to the network.
 Flashing slowly  Flashing slowly	An access point settings error has occurred (a security error).	
 Flashing slowly (white)  Flashing slowly	A network connection error has occurred (the Date and Time has not been set correctly)	Re-set the Date and Time in Web Config.

Related Information

- ➔ [“Removing Jammed Originals from the Scanner” on page 107](#)
- ➔ [“Making Wi-Fi Settings from the Control Panel” on page 86](#)
- ➔ [“Network Problems” on page 113](#)
- ➔ [“Web Config” on page 17](#)

Information on Applications

This section introduces the software products available for your scanner. The latest software can be installed at the Epson Web site.

Epson Scan 2

Epson Scan 2 is a driver for controlling your scanner, enabling a variety of scan settings. This also allows you to start either as a standalone application or by using TWAIN-compliant application software.

See the Epson Scan 2 help for details on using the application.

Document Capture Pro / Document Capture

This application allows you to rearrange pages or correct rotation for image data, and then save the data, send it by email, send it to a server, or send it to a cloud service. By registering frequently used scan process settings with a name such as "job", you can scan by simply selecting "job".

Document Capture Pro is for Windows only. For Mac OS X, use Document Capture, and for Windows Server, use Document Capture Pro Server.

See the Document Capture Pro help for details on using the application.

Presto! BizCard

Presto! BizCard by NewSoft provides a full range of contact management functions for adding business cards without typing. Use the BizCard recognition system to scan business cards, edit, and synchronize the information to the most frequently used personal database management software. You can easily save and manage your contact information.

EPSON Software Updater

EPSON Software Updater is an application that checks for new or updated applications on the internet and installs them.

You can also update the scanner's digital manual.

Note:

Windows Server operating systems are not supported.

Epson DocumentScan

Epson DocumentScan is an application that allows you to scan documents through smart devices such as smartphones and tablet devices. You can save the scanned data in smart devices or cloud services, and send by e-mail. You can download and install this app from the App Store or Google Play.

EpsonNet Config

EpsonNet Config is an application that allows you to set network interface addresses and protocols. See the operations guide for EpsonNet Config or the application's help for more details.

Note:

You can run Web Config from EpsonNet Config.

Web Config

Web Config is an application that allows you to boot in a Web browser such as Internet Explorer or Chrome using a computer or a smart device. You can also set a network service or change settings for scanners. Make sure you connect the scanner and devices to the same network when using Web Config.

To run Web Config, enter the IP address of the scanner on web browser. You can check the IP address on Epson Scan 2.

Scanner Basics

❑ Format:

IPv4: http://the scanner's IP address/

IPv6: http://[the scanner's IP address]/

❑ Examples:

IPv4: http://192.168.100.201/

IPv6: http://[2001:db8::1000:1]/

Note:

You can also run Web Config from EpsonNet Config or using WSD port.

Option Items and Consumables Information

Network Interface Unit Codes

You can scan through a network by using Document Capture Pro (Windows only). By registering frequently used scan process settings such as save, sort, transfer, and so on, with a name such as "job", you can reduce the workload and increase efficiency by simply selecting "job" on the control panel. See the manual for more details.

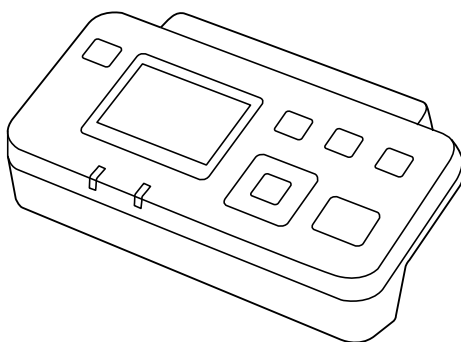

Part name	Codes	Specifications
Network Interface Unit *	B12B808451	Available for 1000BASE-T/100BASE-TX/10BASE-T, IPv6, IEEE802.3az

* When mounted, you cannot use the scanner or a computer over a USB connection.

Carrier Sheet Codes

Using a Carrier Sheet allows you to scan irregular shaped originals or photos that can be easily scratched when feeding paper. You can scan originals larger than A4 size with a carrier sheet by folding it in half.

Part name	Codes
Carrier Sheet*	B12B819051 B12B819061 (China only)

* You can only use the carrier sheet with the code.

Scanner Basics

Related Information

- ➔ [“General Specifications for Originals being Scanned” on page 21](#)
- ➔ [“Placing Large Size Originals” on page 39](#)
- ➔ [“Placing Irregular Shaped Originals” on page 42](#)
- ➔ [“Placing Photographs” on page 45](#)

Roller Assembly Kit Codes

Parts (the pickup roller and a separation roller) should be replaced when the number of scans exceeds the service number. You can check the latest number of scans in Epson Scan 2 Utility.

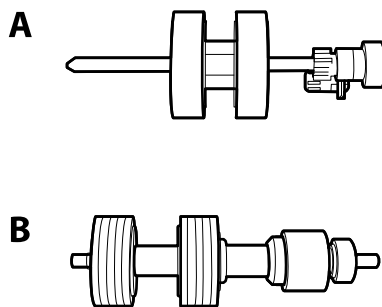

A: pickup roller, B: separation roller

Part name	Codes	Life cycle
Roller Assembly Kit	B12B819031 B12B819041 (China only)	200,000*

* This number was reached by consecutively scanning using Epson test original papers, and is a guide to the replacement cycle. The replacement cycle may vary depending on different paper types, such as paper that generates a lot of paper dust or paper with a rough surface that may shorten the life cycle.

Related Information

- ➔ [“Replacing the Roller Assembly Kit” on page 96](#)
- ➔ [“Resetting the Number of Scans” on page 100](#)

Cleaning Kit Codes

Use this when cleaning inside the scanner.

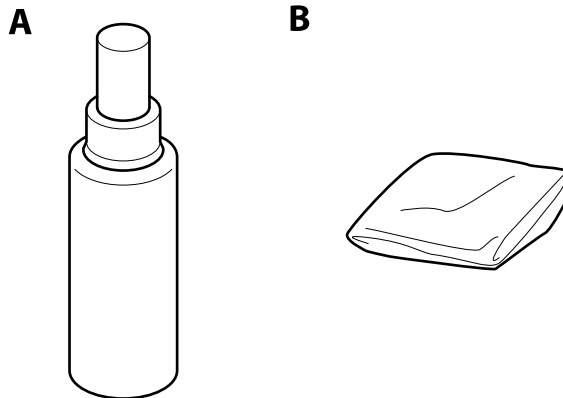

A: cleaner, B: cleaning cloth

Part name	Codes
Cleaning Kit	B12B819291

Related Information

➔ [“Cleaning Inside the Scanner” on page 91](#)

Specifications of Originals and Placing Originals

Specifications of Originals

This section explains the specifications and conditions of originals that can be loaded in the ADF.

General Specifications for Originals being Scanned

Type of Original	Thickness	Size
Plain paper	27 to 413 g/m ²	Maximum: 215.9×6,096.0 mm (8.5×240.0 in.)
Fine paper	A8 size or less: 127 to 413 g/m ²	Minimum: 50.8×50.8 mm (2.0×2.0 in.)
Recycled paper	Plastic cards: 1.24 mm (0.05 in.) or less (including emboss)	The loadable size varies depending on the type of originals.
Post card	Laminated Cards: 0.8 mm (0.03 in.) or less	
Business card		
Envelopes		
Plastic cards complying with ISO781A ID-1 type (with or without emboss)		
Laminated cards		
Thermal paper		

Note:

- ❑ All originals must be flat at the leading edge.
- ❑ Make sure that curls on the leading edge of the originals are kept within the following range.

The ① must be 3 mm or less.

The ② must be 1 mm or less while the ② is equal to or less than ③. When ③ is equal to or more than 10 times the ②, ② can be more than 1 mm.

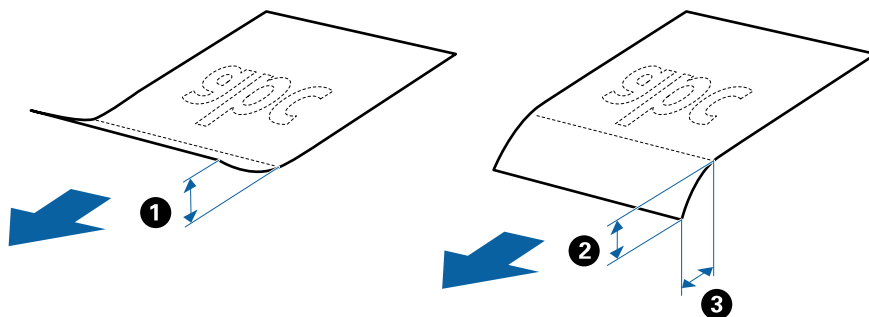

Specifications of Standard Size Originals

The list of the standard size originals you can load on the scanner.

Specifications of Originals and Placing Originals

Size	Measurement	Thickness	Paper Type	Loading Capacity *
A4	210×297 mm (8.3×11.7 in.)	27 to 413 g/m ²	Plain paper Fine paper Recycled paper	Thickness of the originals stack: under 6 mm (0.23 in.) 80 g/m ² : 50 sheets 90 g/m ² : 43 sheets 104 g/m ² : 37 sheets 127 g/m ² : 31 sheets 157 g/m ² : 25 sheets 209 g/m ² : 19 sheets 256 g/m ² : 15 sheets 413 g/m ² : 9 sheets The loading capacity varies depending on the paper type.
Letter	215.9×279.4 mm (8.5×11 in.)			
Legal	215.9×355.6 mm (8.5×14 in.)			
B5	182×257 mm (7.2×10.1 in.)			
A5	148×210 mm (5.8×8.3 in.)			
B6	128×182 mm (5.0×7.2 in.)			
A6	105×148 mm (4.1×5.8 in.)			
A8	52×74 mm (2.1×2.9 in.)	127 to 413 g/m ²		
Business Card	55×89 mm (2.1×3.4 in.)	210 g/m ²		Thickness of the originals stack: under 6 mm (0.23 in.) 15 sheets

* You can refill the originals up to the maximum capacity during scanning.

Specifications of Long Paper

The specification of long paper you can load into the scanner.

Size	Thickness	Paper Type	Loading Capacity
Width: 50.8 to 215.9 mm (2.0 to 8.5 in.) Length: 393.7 to 6,096.0 mm (15.5 to 240.0 in.)	50 to 130 g/m ²	Plain paper Fine paper Recycled paper	1 sheet

Specifications of Plastic Cards

The specification of plastic card you can load into the scanner.

Specifications of Originals and Placing Originals

Size	Card Type	Thickness	Loading Capacity	Loading Direction
ISO781A ID-1 Type 54.0×85.6 mm (2.1×3.3 in.)	With embossing	1.24 mm (0.05 in.) or less	1 card	Horizontal (Landscape)
	Without embossing	0.76 mm (0.03 in.) or less	5 cards	

Specifications of Laminated Cards

The specification of laminated cards you can load into the scanner.

Size	Thickness	Loading Capacity
120.0×150.0 mm (4.7×5.9 in.) or less	0.8 mm (0.03 in.) or less	1 card

Specifications for Originals Using the Carrier Sheet

The optional Carrier Sheet is a sheet designed to transport originals through the scanner. You can scan originals that are larger than A4/Letter size, important documents or photos which must not be damaged, thin paper, irregular shaped originals, and so on.

The following table provides the conditions for using the Carrier Sheet.

Type	Size	Thickness	Loading Capacity of the Carrier Sheet
Originals that cannot be loaded directly into the scanner	A3* ¹ A4 B4* ¹ Letter Legal* ¹ B5 A5 B6 A6 A8 Custom size: <input type="checkbox"/> Width: up to 431.8 mm (17 in.) * ² <input type="checkbox"/> Length: up to 297 mm (11.7 in.) * ³	0.3 mm (0.012 in.) or less (excluding the thickness of the Carrier Sheet)	5 sheets

*1 Fold in half to set.

*2 Originals that are wider than 215.9 mm (8.5 in.) need to be folded in half.

*3 The leading edge of the original must be placed at the binding part of the Carrier Sheet when scanning an original approximately 297 mm (11.7 in.) long. Otherwise, the length of the scanned image may be longer than intended as the scanner scans to the end of the Carrier Sheet when you select **Auto Detect** as the **Document Size** setting in Epson Scan 2.

Specifications of Originals and Placing Originals

Related Information

➔ [“Carrier Sheet Codes” on page 18](#)

Specifications of Envelopes

The specification of envelopes you can load into the scanner.

Size	Measurement	Thickness	Loading Capacity
C6	114×162 mm (4.49×6.38 in.) (standard size)	0.38 mm (0.015 in.) or less	5 envelopes
DL	110×220 mm (4.33×8.66 in.) (standard size)		

Types of Originals that Require Attention

The following types of originals may not be successfully scanned.

- Originals with an uneven surface such as letter head paper.
- Originals with crinkles or fold lines
- Perforated originals
- Original with labels or stickers
- Carbon-less paper
- Curled originals
- Coated paper

Note:

- Because carbon-less paper contains chemical substances that may harm the rollers, if paper jams occur frequently, clean the pickup roller and the separation roller.*
- Crinkled originals may scan better if you slow down the feeding speed during scanning or smooth out the crinkles before loading.*
- To scan delicate originals or originals that are easily crinkled, use the Carrier Sheet (sold separately).*
- To scan originals that are incorrectly detected as double feeds, press the  (Double Feed Detection Skip) button before scanning or select **Off** in **Detect Double Feed** on the **Main Settings** tab in Epson Scan 2.*
- Labels or stickers must be firmly stuck to the originals with no glue protruding.*
- Try to flatten the curled originals before scanning.*

Related Information

- ➔ [“Scanner Basics” on page 11](#)
- ➔ [“Maintenance” on page 91](#)

Types of Originals that Must Not be Scanned

The following types of originals must not be scanned.

Specifications of Originals and Placing Originals

- Photos
- Booklets
- Non-paper original (such as clear files, fabric, and metal foil)
- Originals with staples or paper clips
- Originals with glue attached
- Ripped originals
- Heavily wrinkled or curled originals
- Transparent originals such as OHP film
- Originals with carbon paper on the back
- Originals with wet ink
- Originals with sticky notes attached

Note:

- Do not feed photos, valuable original artwork, or important documents which you do not want to damage or deface into the scanner directly. Misfeeding may wrinkle or damage the original. When scanning such originals, make sure you use the Carrier Sheet (sold separately).*
- Rippled, wrinkled, or curled originals can also be scanned if you use the Carrier Sheet (sold separately).*

Related Information

- ➔ [“Photographs” on page 44](#)

Placing Originals

Standard Size Originals

Specifications of Standard Size Originals

The list of the standard size originals you can load on the scanner.

Specifications of Originals and Placing Originals

Size	Measurement	Thickness	Paper Type	Loading Capacity *
A4	210×297 mm (8.3×11.7 in.)	27 to 413 g/m ²	Plain paper Fine paper Recycled paper	Thickness of the originals stack: under 6 mm (0.23 in.) 80 g/m ² : 50 sheets 90 g/m ² : 43 sheets 104 g/m ² : 37 sheets 127 g/m ² : 31 sheets 157 g/m ² : 25 sheets 209 g/m ² : 19 sheets 256 g/m ² : 15 sheets 413 g/m ² : 9 sheets The loading capacity varies depending on the paper type.
Letter	215.9×279.4 mm (8.5×11 in.)			
Legal	215.9×355.6 mm (8.5×14 in.)			
B5	182×257 mm (7.2×10.1 in.)			
A5	148×210 mm (5.8×8.3 in.)			
B6	128×182 mm (5.0×7.2 in.)			
A6	105×148 mm (4.1×5.8 in.)			
A8	52×74 mm (2.1×2.9 in.)	127 to 413 g/m ²		
Business Card	55×89 mm (2.1×3.4 in.)	210 g/m ²		Thickness of the originals stack: under 6 mm (0.23 in.) 15 sheets

* You can refill the originals up to the maximum capacity during scanning.

Specifications of Originals and Placing Originals

Placing Standard Size Originals

1. Open the input tray and extend the input tray extension. Slide out the output tray, extend the output tray extension, and then raise the stopper.

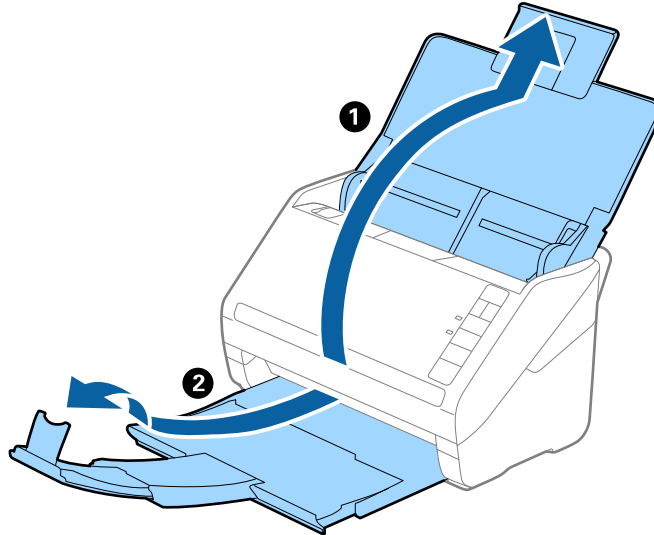

Note:

- ❑ For A4 size or larger originals, make sure you pull out and extend the input tray extension.
- ❑ Make sure you pull out and extend the output tray extensions so that they are a little bit longer than the length of the original, and raise the stopper so that the ejected originals can be stacked comfortably on the output tray.
- ❑ The stopper can move forward and backward on the output tray extension so that you can easily adjust the stopper position to the best position for the originals being scanned.
- ❑ If thick originals bump into the output tray and fall from it, store the output tray and do not use it to stack the ejected originals.
- ❑ If scanned images are still affected by ejected originals hitting the surface below the scanner, we recommend placing the scanner on the edge of a table where the ejected originals can drop freely and you can catch them.

2. Slide the edge guides on the input tray all the way out.

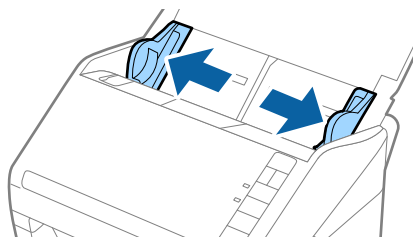

Specifications of Originals and Placing Originals

3. Fan the originals.

Hold both ends of the originals and fan them a few times.

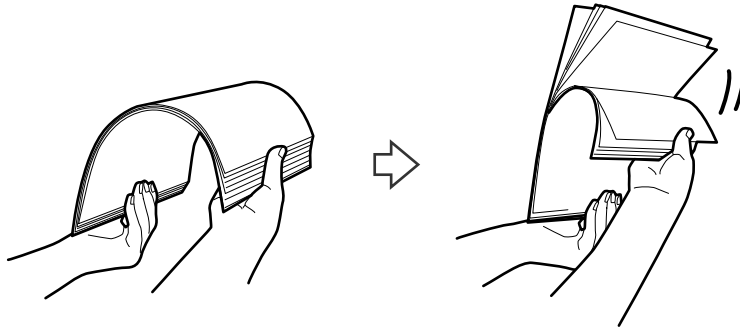

4. Align the edges of the originals with the printed side facing down and slide the leading edge into a wedge shape.

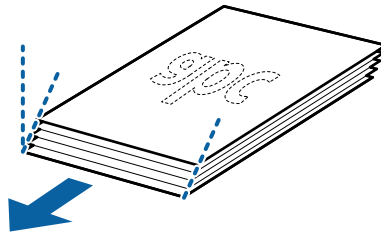

5. Load the originals into the input tray facing down with the top edge facing into the ADF.

Slide the originals into the ADF until they meet resistance.

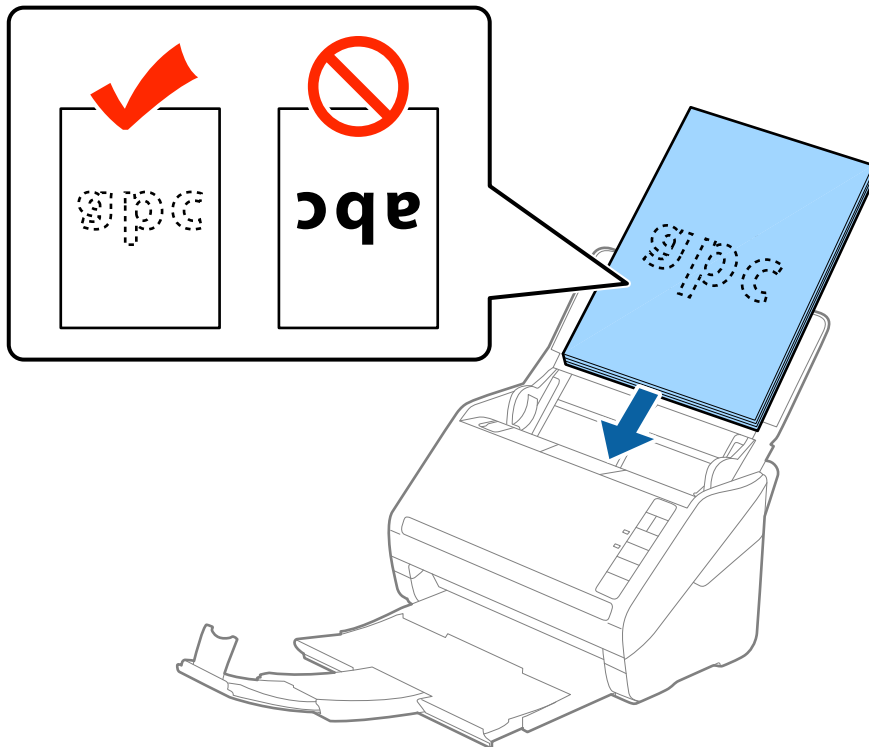

Specifications of Originals and Placing Originals

6. Slide the edge guides to fit the edge of the originals making sure there are no gaps between the originals and the edge guides. Otherwise, the originals may be fed skewed.

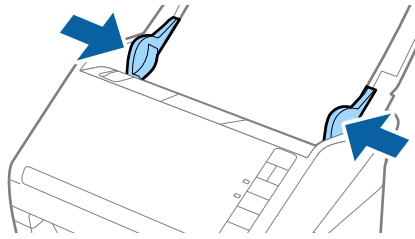



Specifications of Originals and Placing Originals

Note:

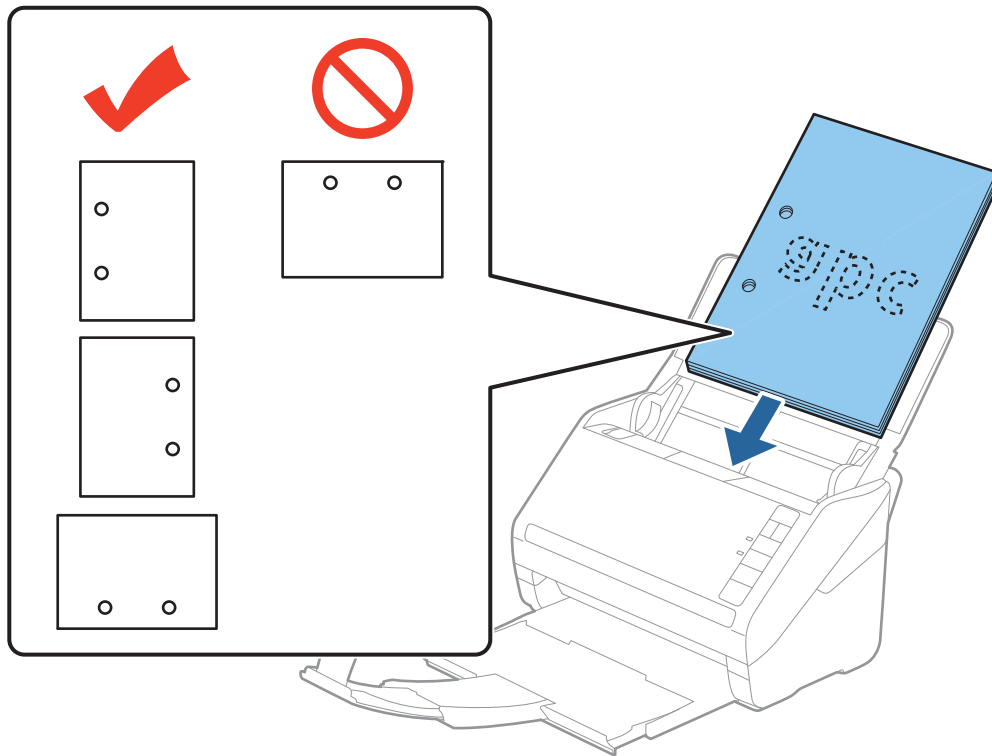
- ❑ When scanning originals with punch holes such as loose leaf paper, load the originals with the holes facing the side or facing down. There must not be any holes within a 30 mm (1.2 inches) strip at the center of the originals. However, there can be holes within 30 mm (1.2 inches) from the leading edge of the originals. Make sure that the edges of the punch holes do not have burrs or curls.



- ❑ When scanning thin paper with crinkles that are causing paper jams or double feeds, you may be able to improve the situation by pressing the  (Slow Mode) button to slow down the feeding speed. Pressing the  (Slow Mode) button once slows down the paper feeding speed; press it again to return to normal speed.

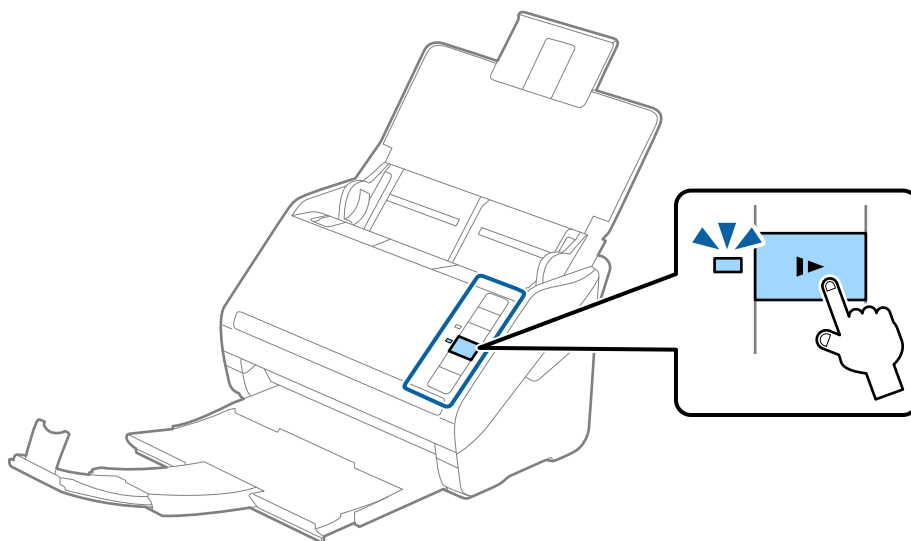

Specifications of Originals and Placing Originals

Long Paper

Specifications of Long Paper

The specification of long paper you can load into the scanner.

Size	Thickness	Paper Type	Loading Capacity
Width: 50.8 to 215.9 mm (2.0 to 8.5 in.) Length: 393.7 to 6,096.0 mm (15.5 to 240.0 in.)	50 to 130 g/m ²	Plain paper Fine paper Recycled paper	1 sheet

Placing Long Paper

1. Open the input tray, and then slide out the output tray.

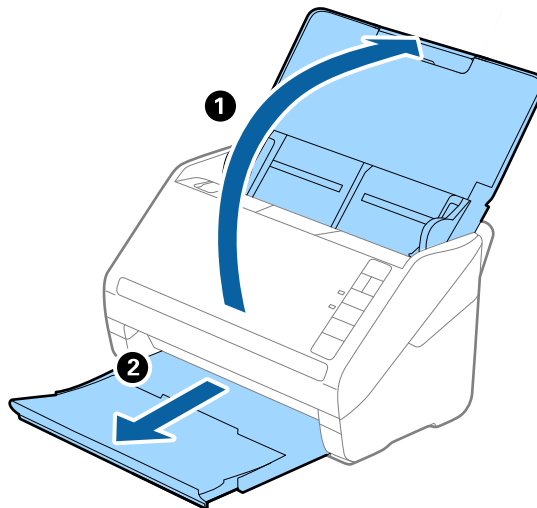

Note:

Do not extend the input tray extension and output tray extensions and do not raise the stopper.

2. Slide the edge guides on the input tray all the way out.

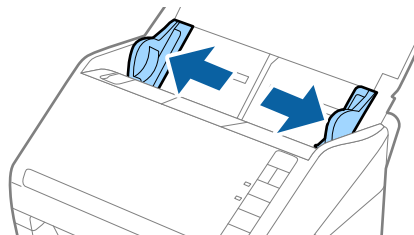

Specifications of Originals and Placing Originals

3. Load the original straight into the input tray, facing down with the top edge facing into the ADF. Slide the original into the ADF until it meets resistance.

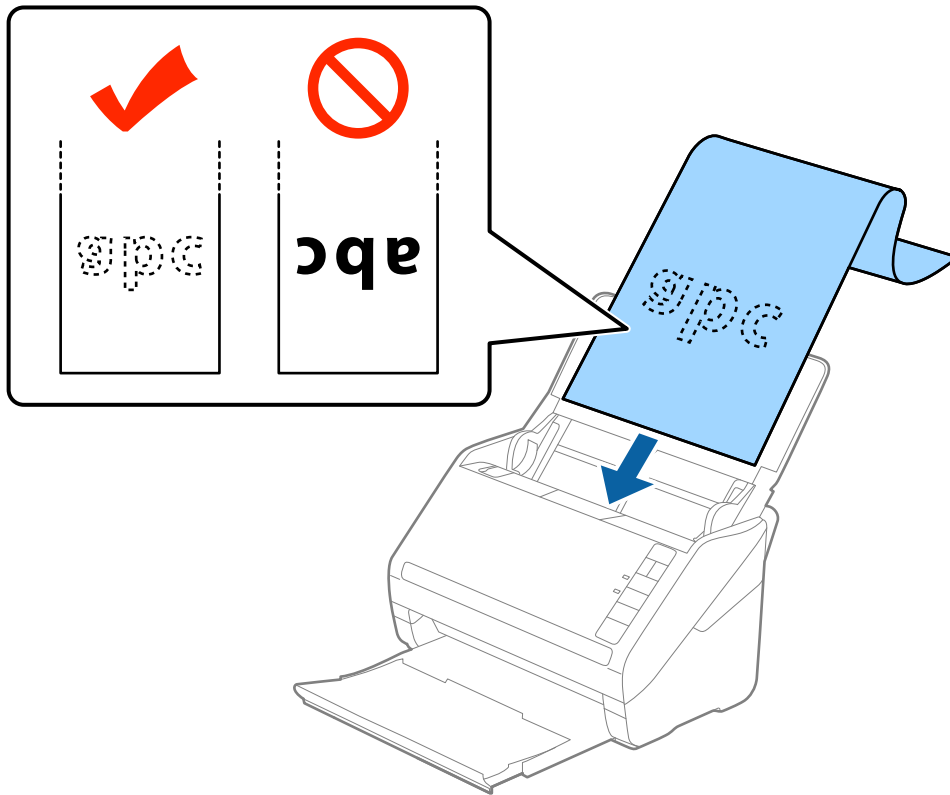

4. Adjust the edge guides to fit the edge of the long paper making sure there are no gaps between the edge of the paper and the edge guides. Otherwise, the originals may be fed skewed.

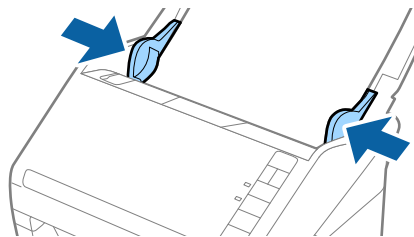

Specifications of Originals and Placing Originals

Note:

❑ You can scan long paper up to 5,461 mm (215 inches) in length with a resolution of 300 dpi or less, and over 5,461 mm (215 inches) to 6,096 mm (240 inches) with a resolution of 200 dpi or less.

❑ You need to specify the paper size in Epson Scan 2. There are three ways to specify the paper size in Epson Scan 2, if the paper length is 863.6 mm (34 inches) or less, you can select **Auto Detect (Long Paper)** to detect the size automatically.

If the paper length is more than 863.6 mm (34 inches), you need to select **Customize** and enter the size of the paper. If the paper length is 5,461 mm (215 inches) or less, you can use **Detect paper length** instead of entering the paper height. If the paper is longer than 5,461 mm (215 inches), you need to enter both width and height size of the paper.

❑ Support the long paper at the input side so that it does not drop out of the ADF, and the output side so that the ejected paper does not fall from the output tray.

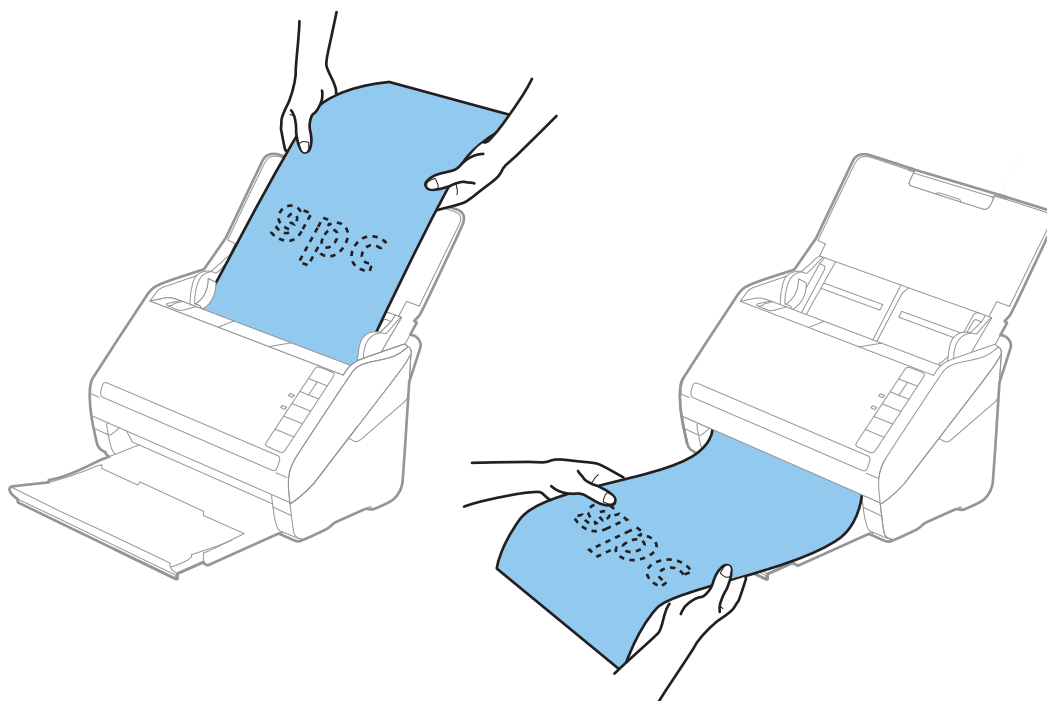

Related Information

➔ [“Required Settings for Special Originals in Epson Scan 2” on page 56](#)

Plastic Cards

Specifications of Plastic Cards

The specification of plastic card you can load into the scanner.

Size	Card Type	Thickness	Loading Capacity	Loading Direction
ISO781A ID-1 Type 54.0×85.6 mm (2.1×3.3 in.)	With embossing	1.24 mm (0.05 in.) or less	1 card	Horizontal (Landscape)
	Without embossing	0.76 mm (0.03 in.) or less	5 cards	

Specifications of Originals and Placing Originals

Placing Plastic Cards

1. Open the input tray, and then slide out the output tray and raise the stopper.

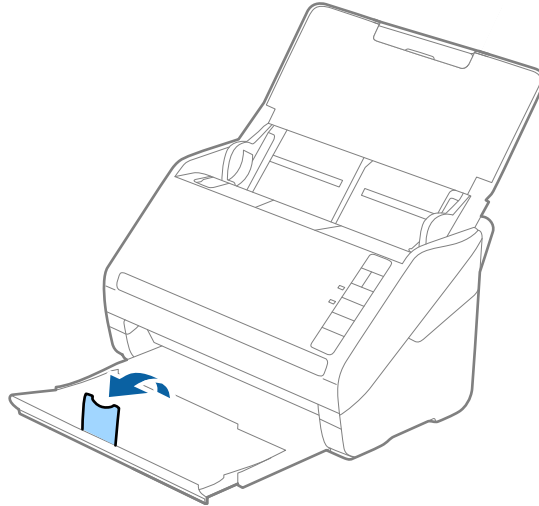

2. Slide the edge guides on the input tray all the way out.

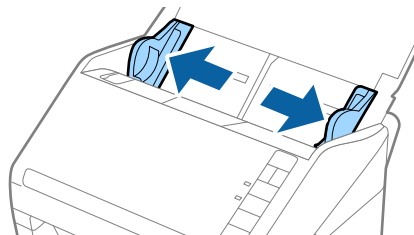

3. Load the plastic cards into the input tray facing down with the top edge facing into the ADF. Slide the plastic cards into the ADF until they meet resistance.

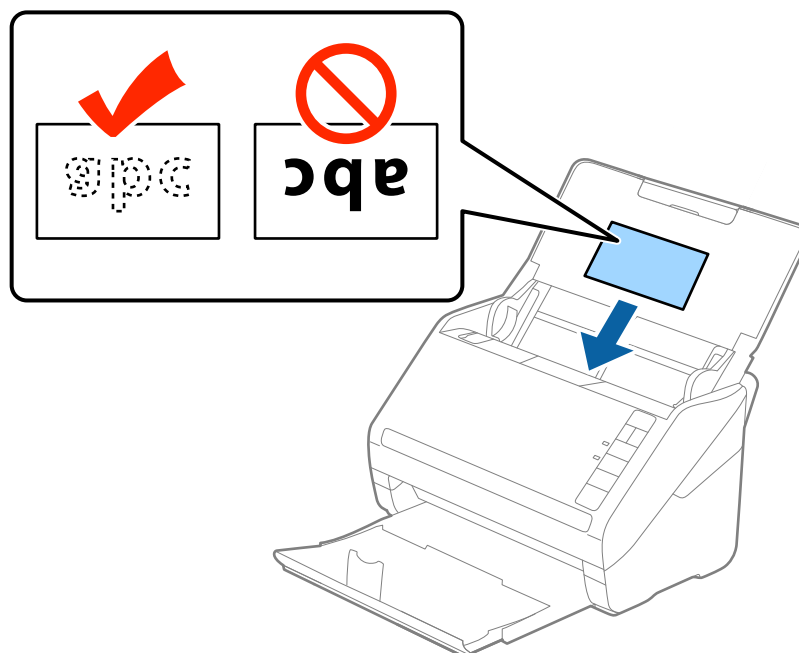

Specifications of Originals and Placing Originals

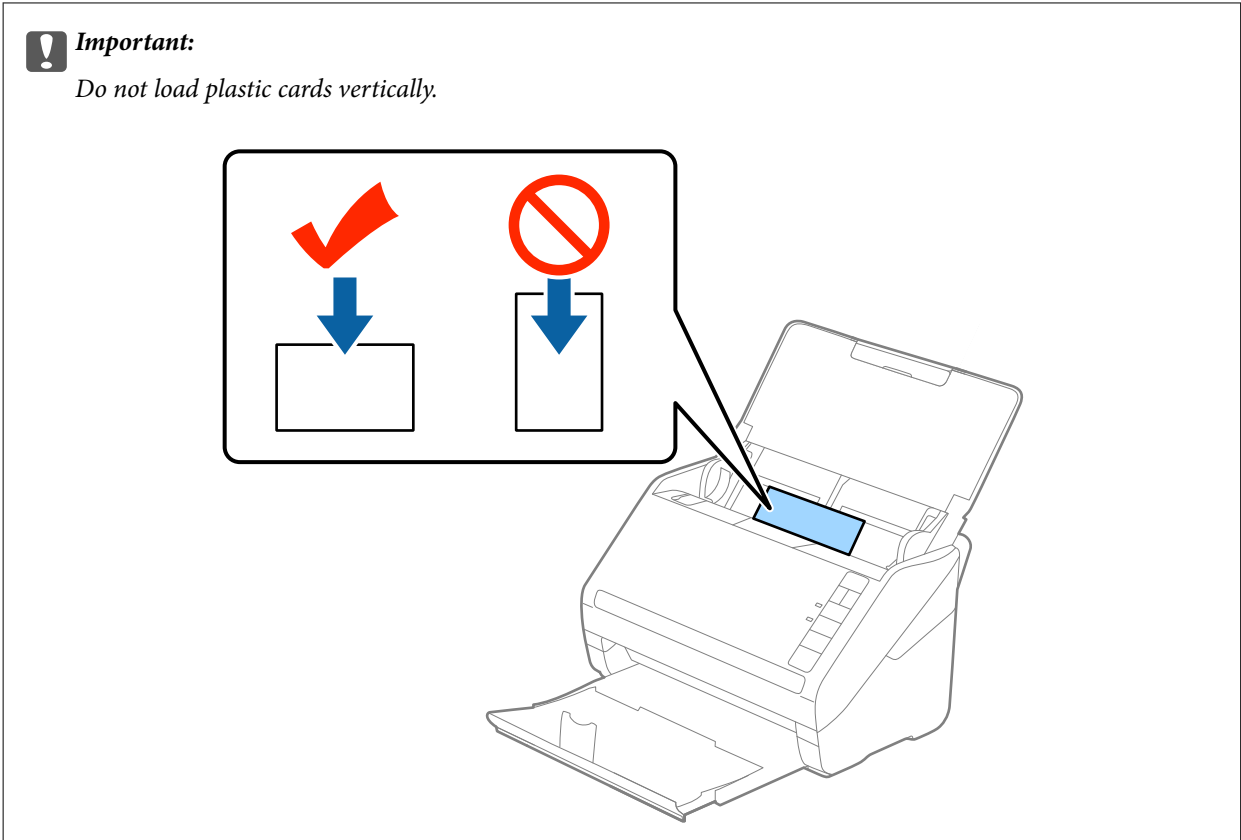

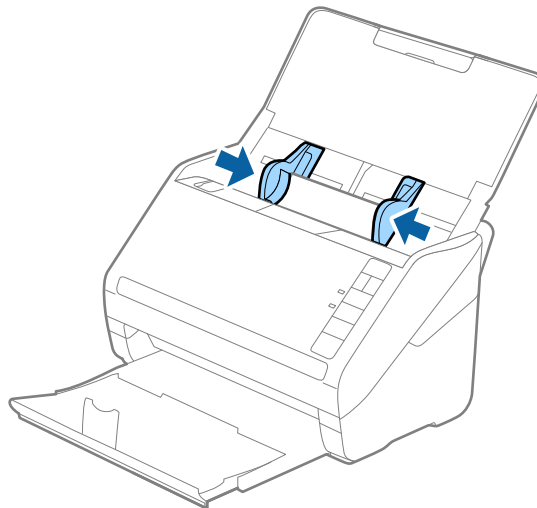

4. Slide the edge guides to fit the edge of the plastic cards.



Specifications of Originals and Placing Originals

Note:

To scan plastic cards, select **Plastic Card (Landscape)** in **Document Size** or select **Off** in **Detect Double Feed** on the **Main Settings** tab in Epson Scan 2. See the Epson Scan 2 help for details.

If you forget to disable **Detect Double Feed** in Epson Scan 2 and a double feed error occurs, remove the card from the ADF and then reload it, press the  (Double Feed Detection Skip) button on the scanner as shown below to disable **Detect Double Feed** for the next scan, and then scan again. The  (Double Feed Detection Skip) button only disables **Detect Double Feed** for one sheet.

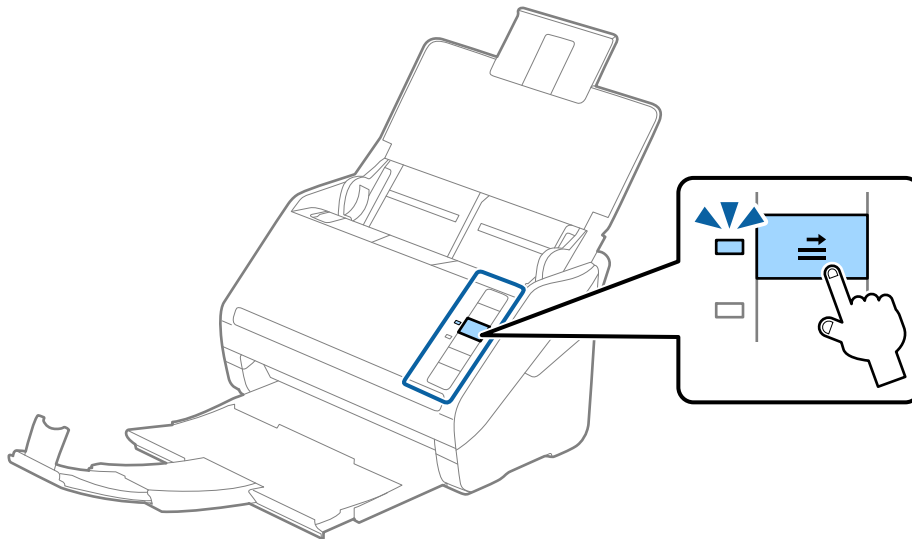

Related Information

➔ [“Required Settings for Special Originals in Epson Scan 2” on page 56](#)

Laminated Cards

Specifications of Laminated Cards

The specification of laminated cards you can load into the scanner.

Size	Thickness	Loading Capacity
120.0×150.0 mm (4.7×5.9 in.) or less	0.8 mm (0.03 in.) or less	1 card

Specifications of Originals and Placing Originals

Placing Laminated Cards

1. Open the input tray, and then slide out the output tray and raise the stopper.

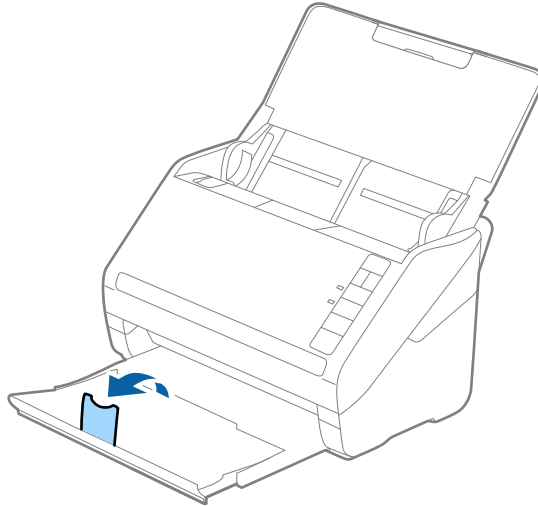

2. Slide the edge guides on the input tray all the way out.

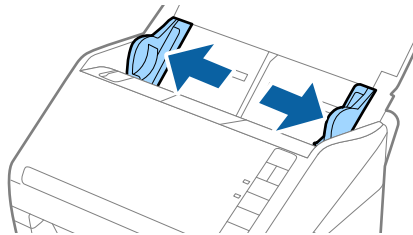

3. Load the laminated cards into the input tray facing down with the top edge facing into the ADF. Slide the laminated cards into the ADF until they meet resistance.

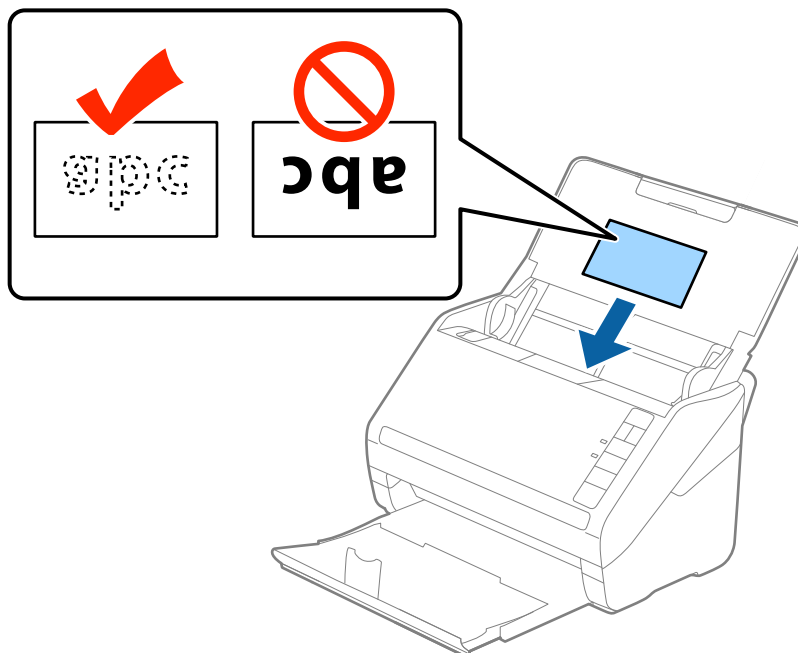

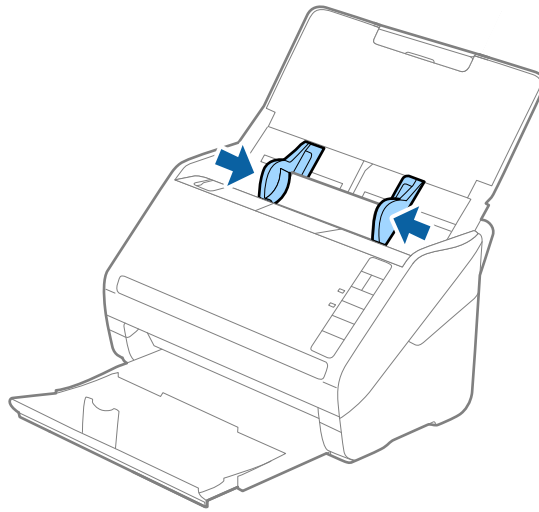

Specifications of Originals and Placing Originals

- Slide the edge guides to fit the edge of the laminated cards.



Note:

- ❑ To scan laminated cards, select **Scan laminated card** on the **Settings** window on the **Main Settings** tab in Epson Scan 2 to increase the accuracy of auto size detection. See the Epson Scan 2 help for details.
- ❑ To scan laminated cards, select **Off** in **Detect Double Feed** on the **Main Settings** tab in Epson Scan 2. See the Epson Scan 2 help for details.

If you forget to disable **Detect Double Feed** in Epson Scan 2 and a double feed error occurs, remove the card from the ADF and then reload it, press the  (Double Feed Detection Skip) button on the scanner as shown below to disable **Detect Double Feed** for the next scan, and then scan again. The  (Double Feed Detection Skip) button only disables **Detect Double Feed** for one sheet.

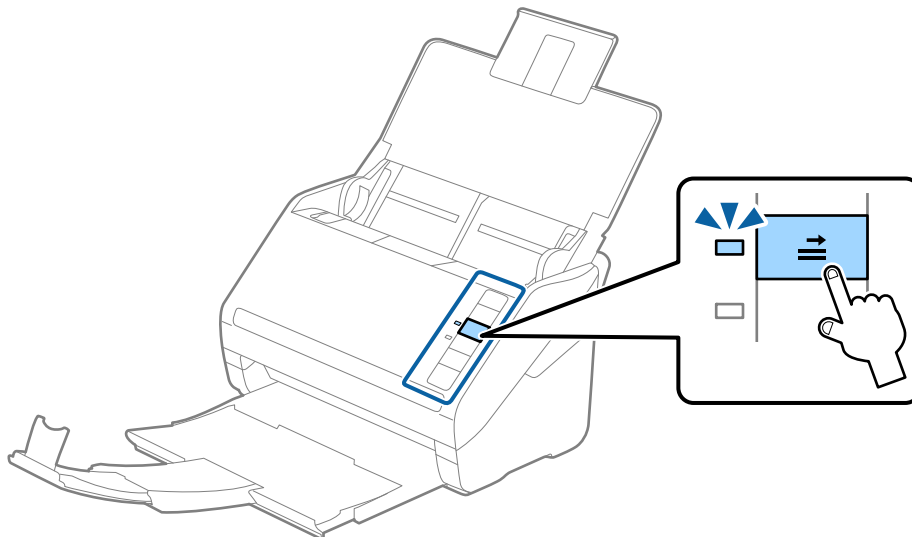

Related Information

- ➔ [“Required Settings for Special Originals in Epson Scan 2” on page 56](#)

Specifications of Originals and Placing Originals

Large Size Originals

Specifications of Large Size Originals

By using the Carrier Sheet sold separately and folding the originals in half, you can scan originals larger than A4 size, such as A3 or B4 sizes.

Size	Thickness	Paper Type	Loading Capacity of the Carrier Sheet
Up to A3	0.3 mm (0.012 in.) or less (excluding the thickness of the Carrier Sheet)	Plain paper Fine paper Recycled paper	5 carrier sheets

Placing Large Size Originals

1. Open the input tray and extend the input tray extension. Slide out the output tray, extend the output tray extension, and then raise the stopper.

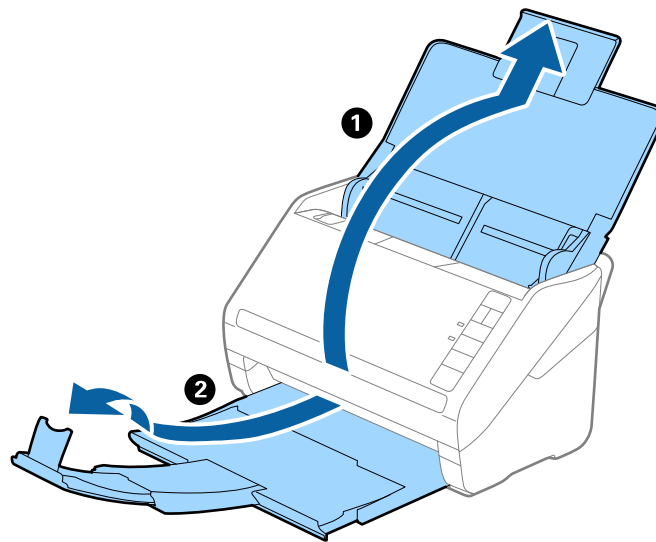

2. Slide the edge guides on the input tray all the way out.

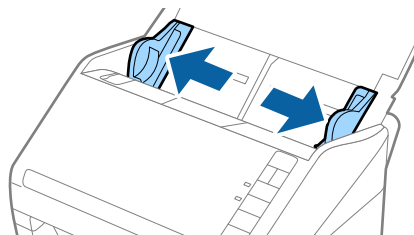

Specifications of Originals and Placing Originals

- Place the Carrier Sheet with the illustration on the front edge facing up and place the original in the carrier sheet by folding it in half so that the side to be scanned is facing out, with the right side at the front.

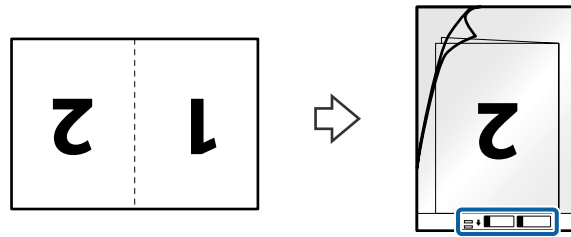

- Load the Carrier Sheet into the input tray with the top edge facing into the ADF. Slide the Carrier Sheet into the ADF until it meets resistance.

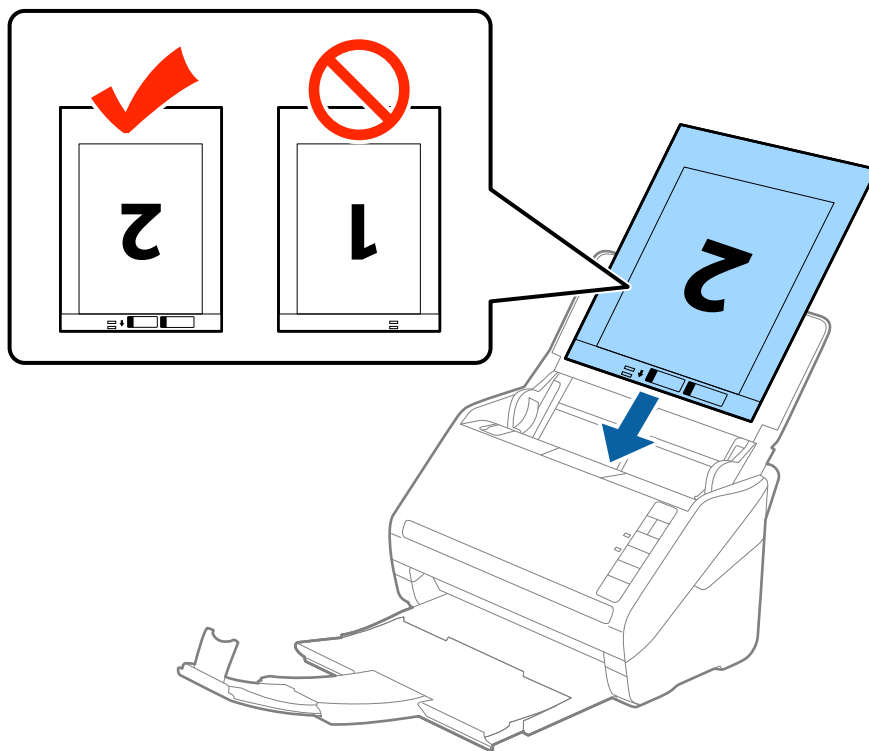

- Slide the edge guides to fit the edge of the Carrier Sheet making sure there are no gaps between the Carrier Sheet and the edge guides. Otherwise, the carrier sheet may be fed skewed.

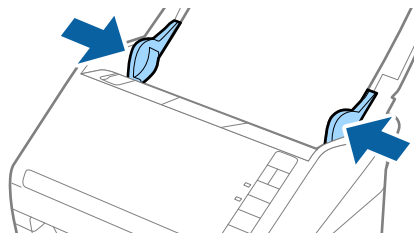

Specifications of Originals and Placing Originals

Note:

- ❑ You may need to stop using a Carrier Sheet that is scratched or has been scanned more than 3,000 times.
- ❑ To scan both sides and stitch them together, select **Double-Sided** from **Scanning Side** and select **Left & Right** from **Stitch Images** in Epson Scan 2. See the Epson Scan 2 help for details.
- ❑ When scanning a Carrier Sheet by selecting **Auto Detect** as the **Document Size** setting, the image is automatically scanned by applying **Paper Skew** in the **Correct Document Skew** setting.
- ❑ The leading edge of the original must be placed at the binding part of the Carrier Sheet when scanning an original approximately 297 mm long. Otherwise, the length of the scanned image may be longer than intended as the scanner scans to the end of the Carrier Sheet when you select **Auto Detect** as the **Document Size** setting in Epson Scan 2.
- ❑ Only use the Carrier Sheet designed for your scanner. The Carrier Sheet is automatically recognized by the scanner by detecting two small rectangular holes on the front edge. Keep the holes clean and not covered.

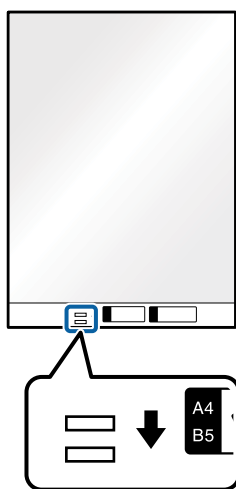

Related Information

- ➔ [“Carrier Sheet Codes” on page 18](#)
- ➔ [“Required Settings for Special Originals in Epson Scan 2” on page 56](#)

Irregular Shaped Originals

Specifications of Irregular Shaped Originals

By using the Carrier Sheet sold separately, you can scan originals that are wrinkled, curled, very thin, or irregularly shaped.

Size	Thickness	Loading Capacity of the Carrier Sheet
Up to A4	0.3 mm (0.012 in.) or less (excluding the thickness of the Carrier Sheet)	5 sheets

Specifications of Originals and Placing Originals

Placing Irregular Shaped Originals

1. Open the input tray and extend the input tray extension. Slide out the output tray, extend the output tray extension, and then raise the stopper.

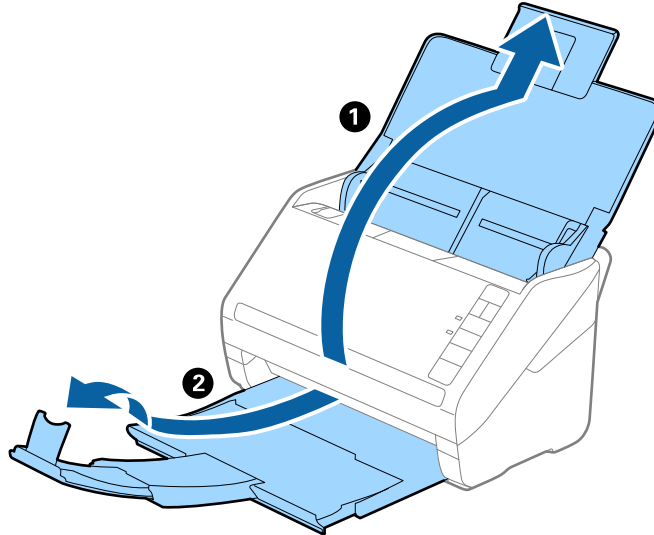

2. Slide the edge guides on the input tray all the way out.

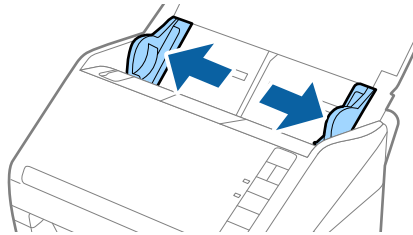

3. Place the Carrier Sheet with the illustration on the front edge facing up and place the original in the center of the Carrier Sheet with the side to be scanned facing down.

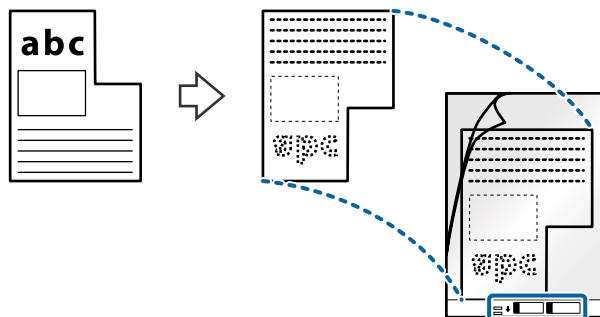

Specifications of Originals and Placing Originals

4. Load the Carrier Sheet into the input tray with the top edge facing into the ADF.
Slide the Carrier Sheet into the ADF until it meets resistance.

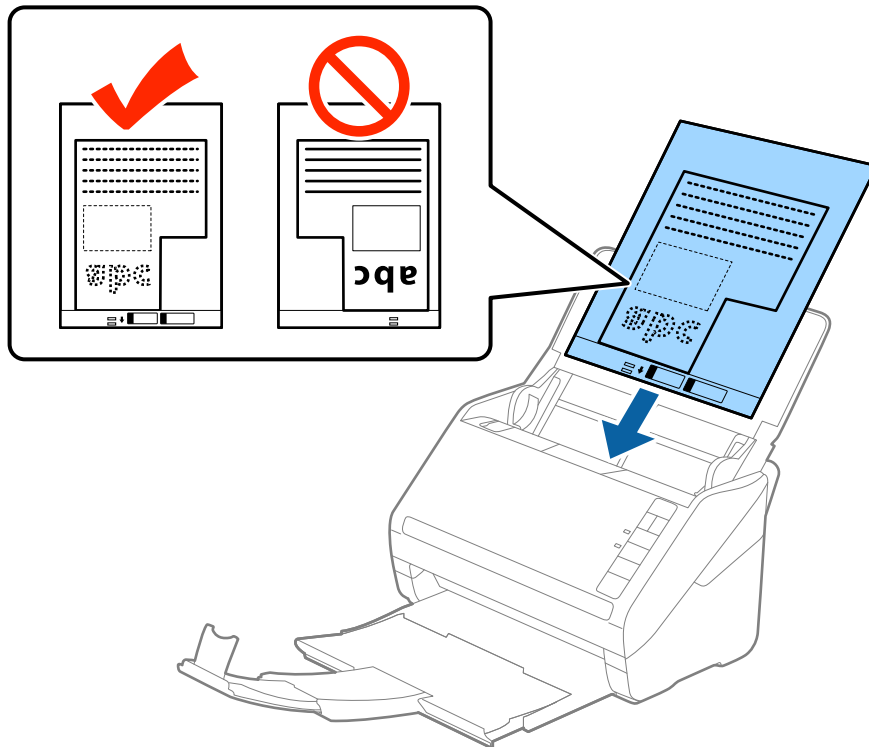

5. Slide the edge guides to fit the edge of the Carrier Sheet making sure there are no gaps between the Carrier Sheet and the edge guides. Otherwise, the carrier sheet may be fed skewed.

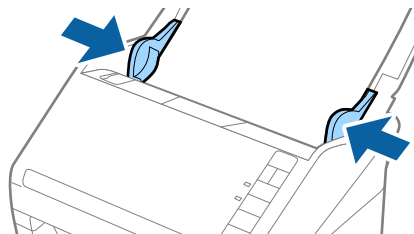

Specifications of Originals and Placing Originals

Note:

- ❑ You may need to stop using a Carrier Sheet that is scratched or has been scanned more than 3,000 times.
- ❑ If you cannot find an appropriate size for the original you want to scan in the **Document Size** list in Epson Scan 2, select **Auto Detect** or select **Customize** to create a custom document size.
When scanning a Carrier Sheet by selecting **Auto Detect** as the **Document Size** setting, the image is automatically scanned by applying **Paper Skew** in the **Correct Document Skew** setting.
- ❑ Only use the Carrier Sheet designed for your scanner. The Carrier Sheet is automatically recognized by the scanner by detecting two small rectangular holes on the front edge. Keep the holes clean and not covered.

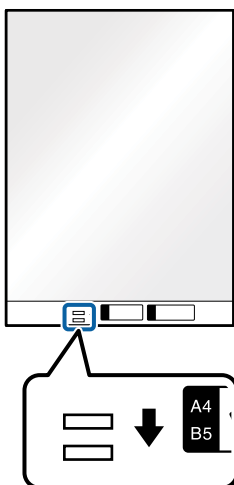

Related Information

- ➔ [“Carrier Sheet Codes” on page 18](#)
- ➔ [“Required Settings for Special Originals in Epson Scan 2” on page 56](#)

Photographs

Specifications of Photographs

By using the Carrier Sheet sold separately, you can scan photographs without worrying about them being damaged.

Size	Thickness	Loading Capacity of the Carrier Sheet
Up to A4	0.3 mm (0.012 in.) or less (excluding the thickness of the Carrier Sheet)	5 sheets

Specifications of Originals and Placing Originals

Placing Photographs

1. Open the input tray and extend the input tray extension. Slide out the output tray, extend the output tray extension, and then raise the stopper.

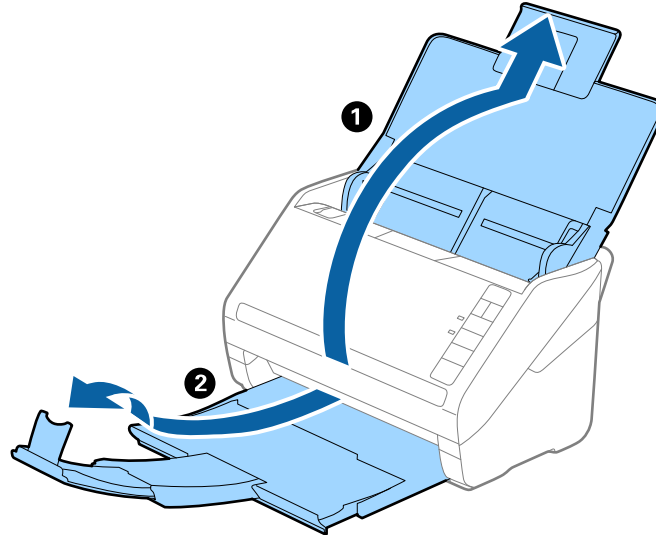

2. Slide the edge guides on the input tray all the way out.

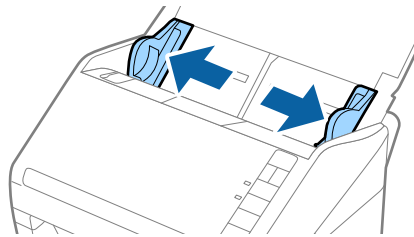

3. Place the Carrier Sheet with the illustration on the front edge facing up and place the photo in the center of the Carrier Sheet with the side to be scanned facing down.

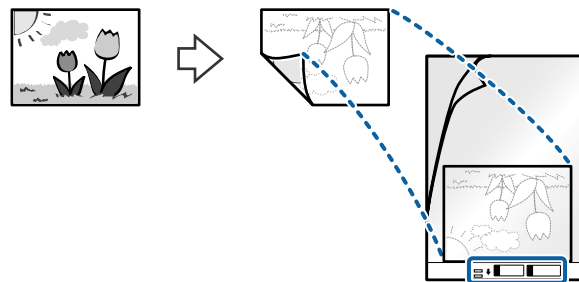

Specifications of Originals and Placing Originals

4. Load the Carrier Sheet into the input tray with the top edge facing into the ADF.
Slide the Carrier Sheet into the ADF until it meets resistance.

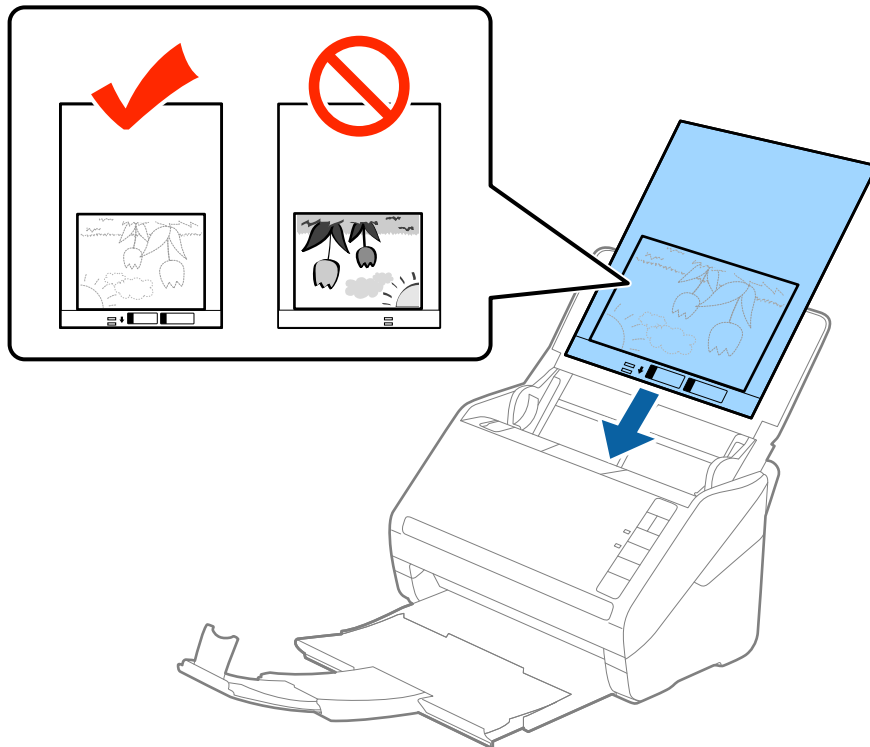

5. Slide the edge guides to fit the edge of the Carrier Sheet making sure there are no gaps between the Carrier Sheet and the edge guides. Otherwise, the carrier sheet may be fed skewed.

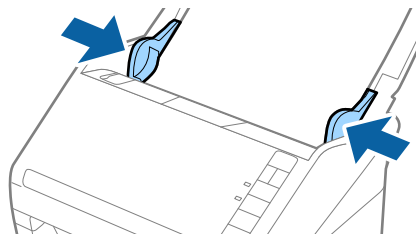

Specifications of Originals and Placing Originals

Note:

- ❑ You may need to stop using a Carrier Sheet that is scratched or has been scanned more than 3,000 times.
- ❑ If you cannot find an appropriate size for the original you want to scan in the **Document Size** list in Epson Scan 2, select **Auto Detect** or select **Customize** to create a custom document size.
When scanning a Carrier Sheet by selecting **Auto Detect** as the **Document Size** setting, the image is automatically scanned by applying **Paper Skew** in the **Correct Document Skew** setting.
- ❑ Do not leave photos inside the Carrier Sheet for a long time.
- ❑ Only use the Carrier Sheet designed for your scanner. The Carrier Sheet is automatically recognized by the scanner by detecting two small rectangular holes on the front edge. Keep the holes clean and not covered.

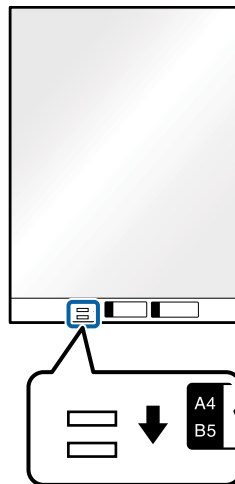

Related Information

- ➔ [“Carrier Sheet Codes” on page 18](#)
- ➔ [“Required Settings for Special Originals in Epson Scan 2” on page 56](#)

Envelopes

Specifications of Envelopes

The specification of envelopes you can load into the scanner.

Size	Measurement	Thickness	Loading Capacity
C6	114×162 mm (4.49×6.38 in.) (standard size)	0.38 mm (0.015 in.) or less	5 envelopes
DL	110×220 mm (4.33×8.66 in.) (standard size)		

Specifications of Originals and Placing Originals

Placing Envelopes

1. Open the input tray and extend the input tray extension. Slide out the output tray, extend the output tray extension, and then raise the stopper.

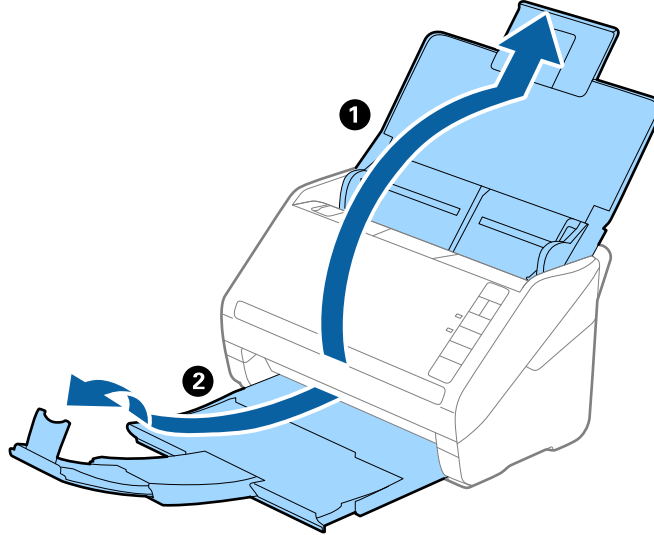

2. Slide the edge guides on the input tray all the way out.

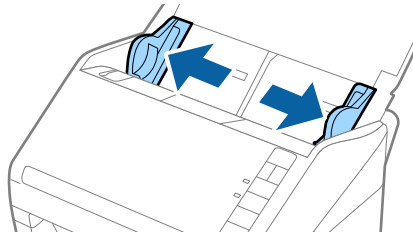

Specifications of Originals and Placing Originals

3. Load the envelopes into the input tray facing down making sure that the opened edge (flap side) of the envelope is facing to the side. For envelopes with the opened edge (flap side) on the shorter side, you can load the envelope with the opened edge (flap side) facing up.

Slide the envelopes into the ADF until they meet resistance.

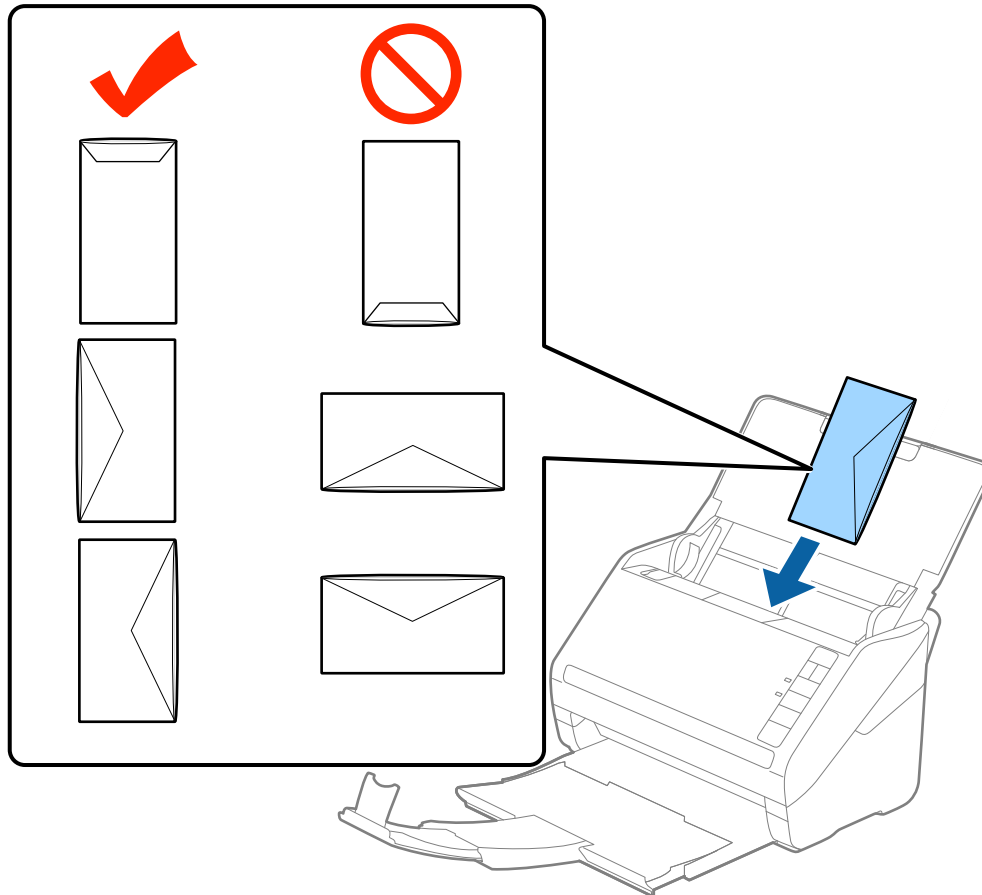

Important:

Do not load envelopes with adhesives on them.

Note:

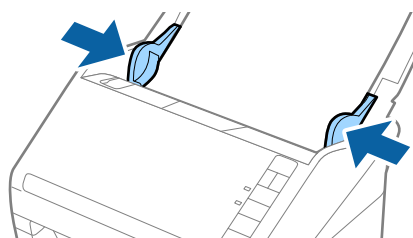

- ❑ Envelopes that are not opened by cutting sharply at the flap edge may not be scanned correctly.
 - ❑ Envelopes that have not yet been sealed can be loaded with the flap open and facing up.
4. Slide the edge guides to fit the edge of the envelopes making sure there are no gaps between the envelopes and the edge guides. Otherwise, the envelopes may be fed skewed.



Specifications of Originals and Placing Originals

Note:

- ❑ To scan envelopes, we recommend selecting the appropriate rotation angle or **Auto** in **Rotate** on the **Main Settings** tab in Epson Scan 2 before scanning. See the Epson Scan 2 help for details.
- ❑ To scan envelopes, select **Off** in **Detect Double Feed** on the **Main Settings** tab in Epson Scan 2. See the Epson Scan 2 help for details.

If you forget to disable **Detect Double Feed** in Epson Scan 2 and a double feed error occurs, remove the envelope from the ADF and then reload it, press the  (Double Feed Detection Skip) button on the scanner as shown below to disable **Detect Double Feed** for the next scan, and then scan again. The  (Double Feed Detection Skip) button only disables **Detect Double Feed** for one sheet.

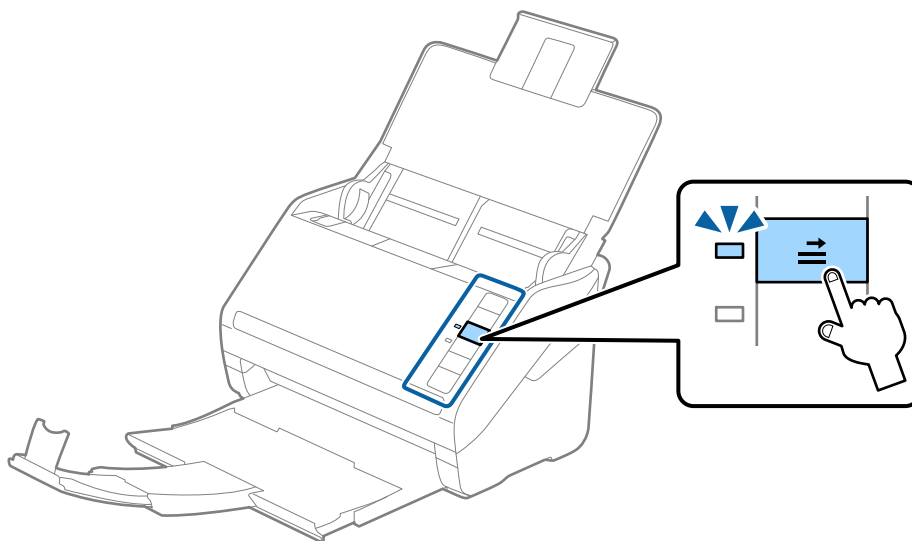

Related Information

- ➔ [“Required Settings for Special Originals in Epson Scan 2” on page 56](#)

Mixture of Originals

Specifications of Originals that are a Mixture of Different Sizes

You can load a mixture of originals from 50.8×50.8 mm (2.0×2.0 in.) to A4 (or Letter) size. You can also load a mixture of paper types or thickness.

Note:

- ❑ Depending on the combination of paper types or sizes, the originals may not be fed correctly and may be skewed or jammed. We recommend that you check the scanned image if the original was skewed.
- ❑ Alternatively, you can scan originals of different paper sizes and types by loading them one by one using **Automatic Feeding Mode**.

Specifications of Originals and Placing Originals

Placing a Mixture of Originals at Different Sizes

1. Open the input tray and extend the input tray extension. Slide out the output tray, extend the output tray extension, and then raise the stopper.

Note:

If there are any thick originals amongst the originals, to stop the thick originals from bumping into the output tray and falling out, store the output tray and do not use it to stack the ejected originals.

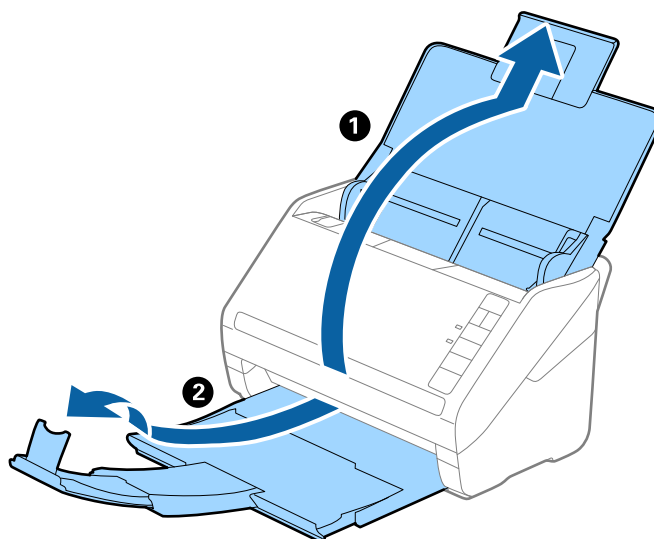

2. Slide the edge guides on the input tray all the way out.

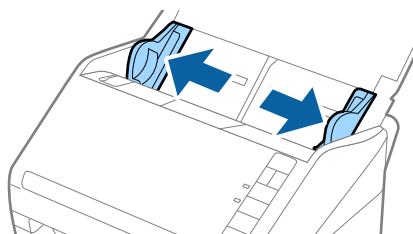

Specifications of Originals and Placing Originals

3. Load the originals at the center of the input tray in descending order of paper size with the widest at the back and the narrowest at the front.

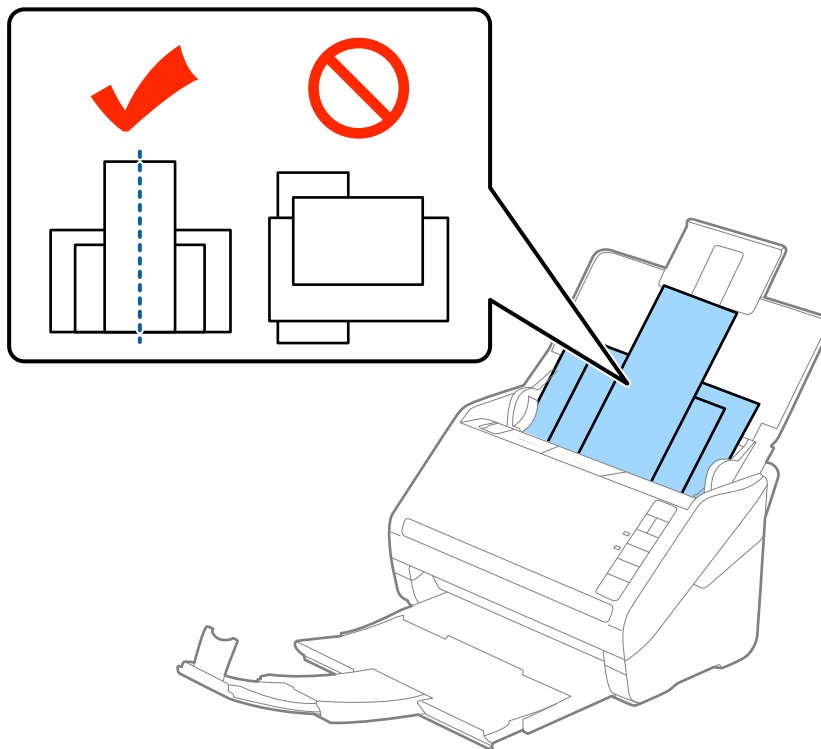

Note:

- ❑ Load the originals into the input tray facing down and slightly displace the top edges at an angle facing into the ADF.
- ❑ Slide the originals into the ADF until they meet resistance.

4. Slide the edge guides to fit the edges of the widest original.

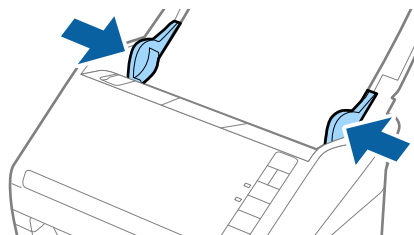

Related Information

- ➔ [“Scanning Different Sizes or Types of Originals One by One \(Automatic Feeding Mode\)”](#) on page 64

Basic Scanning

Scanning Using Epson Scan 2

You can scan the originals using detailed settings that are suitable for text documents.

1. Place the original.
2. Start Epson Scan 2.
 - Windows 10
Click the start button, and then select **All apps > EPSON > Epson Scan 2**.
 - Windows 8.1/Windows 8/Windows Server 2012 R2/Windows Server 2012
Enter the application name in the search charm, and then select the displayed icon.
 - Windows 7/Windows Vista/Windows XP/Windows Server 2008 R2/Windows Server 2008/Windows Server 2003 R2/Windows Server 2003
Click the start button, and select **All Programs** or **Programs > EPSON > Epson Scan 2 > Epson Scan 2**.
 - Mac OS X
Select **Go > Applications > Epson Software > Epson Scan 2**.

Basic Scanning

3. Make the following settings on the **Main Settings** tab.

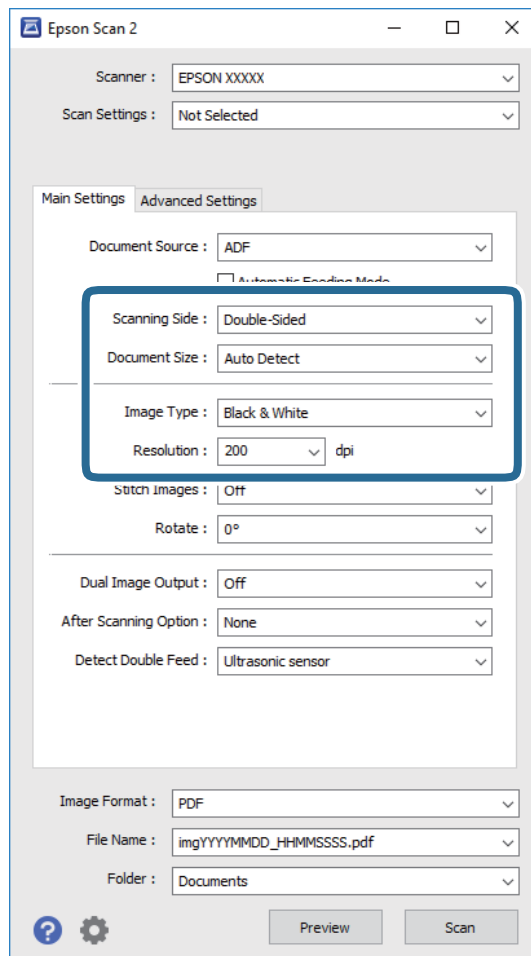

- ❑ **Scanning Side:** Select the side of the original you want to scan.
- ❑ **Document Size:** Select the size of the original you placed.
- ❑ **Image Type:** Select the color for saving the scanned image.
- ❑ **Resolution:** Select the resolution.

Note:

*ADF is set as the **Document Source** automatically.*

4. Make other scan settings if necessary.
- ❑ You can preview the scanned image by click the **Preview** button. The preview window opens, and the previewed image is displayed.
A preview is generated, and the original is ejected from the ADF. Place the ejected original again.

Basic Scanning

- ❑ On the **Advanced Settings** tab, you can make image adjustments using detailed settings which are suitable for text documents, such as the following.
 - ❑ **Unsharp Mask:** Select to enhance and sharpen the outlines of the image.
 - ❑ **Descreening:** Select to remove moiré patterns (web-like shadows) that appear when scanning printed papers such as a magazine.
 - ❑ **Text Enhancement:** Select to make blurred letters in the original clear and sharp.
 - ❑ **Auto Area Segmentation:** Select to make letters clear and images smooth when performing black and white scanning for a document that contains images.

Note:

Some items may not be available depending on other settings you made.

5. Set the file saving settings.

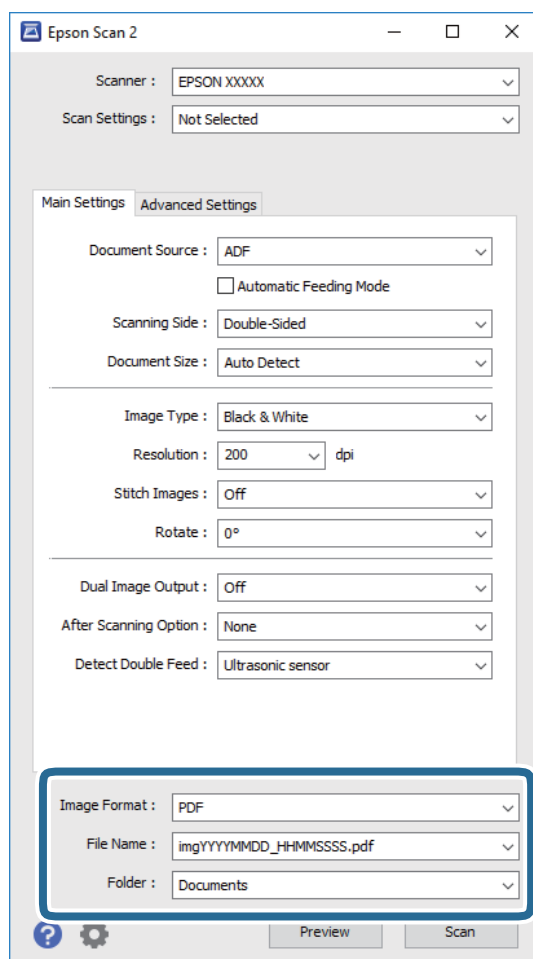

- ❑ **Image Format:** Select the save format from the list.
You can make detailed settings for each save format except BITMAP and PNG. After selecting the save format, select **Options** from the list.
- ❑ **File Name:** Check the save file name displayed.
You can change settings for file name by selecting **Settings** from the list.
- ❑ **Folder:** Select the save folder for the scanned image from the list.
You can select other folder or create a new folder by selecting **Select** from the list.

Basic Scanning

6. Click **Scan**.

The scanned image is saved to the folder you specified.

Related Information

- ➔ [“Placing Originals” on page 25](#)
- ➔ [“Epson Scan 2” on page 16](#)
- ➔ [“Setting a Resolution That Suits the Scanning Purpose” on page 57](#)
- ➔ [“Image Adjustment Features” on page 65](#)
- ➔ [“Editing Scanned Pages Using Epson Scan 2” on page 72](#)

Required Settings for Special Originals in Epson Scan 2

You need to set certain items on the **Main Settings** tab in Epson Scan 2 when scanning special originals.

Type of Original	Required Settings
Envelopes	Select Off in Detect Double Feed .
Plastic cards	Select Plastic Card (Landscape) on the Document Size list, or select Off in Detect Double Feed .
Carrier Sheet	<input type="checkbox"/> If you select Auto Detect from the Document Size list, paper skew in the original is automatically corrected even if you select Off in Correct Document Skew . <input type="checkbox"/> If you select a other size than Auto Detect from the Document Size list, you can only use Contents Skew when using Correct Document Skew . Paper Skew is not applied when this is selected. When you select Paper and Contents Skew , only contents skew is corrected.
Large size originals	If the size of the original you want to scan is not on the Document Size list, select Customize to open the Document Size Settings window. Next, create the size manually on the window.
Long paper	If the size is not listed on the Document Size list, select Auto Detect (Long Paper) or select Customize to create a custom document size.
Laminated cards	To scan transparent areas around the edges, select Customize on the Document Size list to open the Document Size Settings window. Next, select Scan laminated card in the window. Note: <i>The appropriate effect may not be achieved depending on the original. If transparent areas around the edges are not scanned, select Customize from the Document Size list, and then create the size manually.</i>

Related Information

- ➔ [“Placing Originals” on page 25](#)

Setting a Resolution That Suits the Scanning Purpose

Advantages and Disadvantages of Increasing the Resolution

Resolution indicates the number of pixels (smallest area of an image) for each inch (25.4 mm), and is measured in dpi (dots per inch). The advantage of increasing the resolution is that the details in the image become fine. The disadvantage is that the file size becomes large.

- File size becomes large
(When you double the resolution, the file size becomes about four times larger.)
- Scanning, saving, and reading the image takes a long time
- Sending and receiving emails or faxes takes a long time
- The image becomes too large to fit the display or print on the paper

List of Recommended Resolutions to Suit Your Purpose

See the table and set the appropriate resolution for the purpose of your scanned image.

Purpose	Resolution (Reference)
Displaying on the screen Sending by email	Up to 200 dpi
Using Optical Character Recognition (OCR) Creating a text searchable PDF	200 to 300 dpi
Printing using a printer Sending by fax	200 to 300 dpi

Scanning Using Document Capture Pro (Windows)

This application allows you to perform various tasks such as saving the image to your computer, sending it by email, printing, and uploading to a server or a cloud service. You can also use a variety of methods to sort the documents into separate files, such as detecting barcodes or characters on the pages. You can also register scanning settings for a job to simplify scanning operations. See the help for details on Document Capture Pro.

1. Place the original.
2. Start Document Capture Pro.
 - Windows 10
Click the start button, and then select **All apps > Epson Software > Document Capture Pro.**
 - Windows 8.1/Windows 8
Enter the application name in the search charm, and then select the displayed icon.
 - Windows 7/Windows Vista/Windows XP
Click the start button, and then select **All Programs or Programs > Epson Software > Document Capture Pro.**

Basic Scanning

Note:

You may need to select the scanner you want to use from the scanners list.

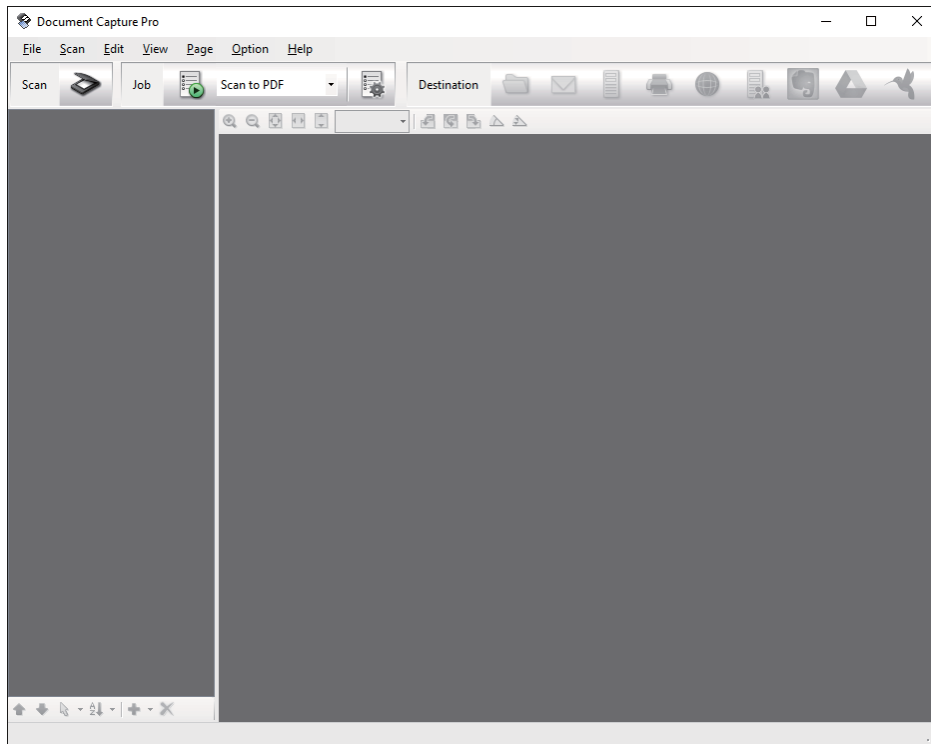

3. Click .

The **Scan** window is displayed.

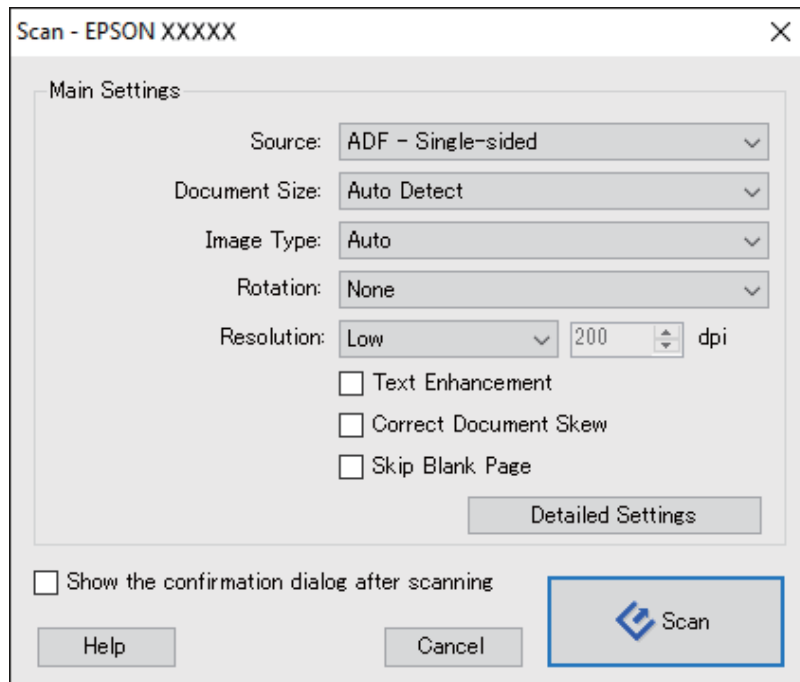

4. Make the following settings.

- Source:** Select the source where the original is placed.

Basic Scanning

- Document Size:** Select the size of the original you placed.
- Image Type:** Select the color you want to use to save the scanned image.
- Rotation:** Select the rotation angle depending on the original you want to scan.
- Resolution:** Select the resolution.

Note:

You can also adjust the image using following items.

- Text Enhancement:** Select to make blurred letters in the original clear and sharp.
- Correct Document Skew:** Select to correct the slant of the original.
- Skip Blank Page:** Select to skip blank pages if there are any in the originals.
- Detailed Settings** button: Select to use Epson Scan 2 features to adjust scanned images.

5. Click **Scan**.

The scanned document is displayed in Document Capture Pro.

6. Check the scanned images, and edit them if necessary.

7. When you have finished checking the image, click one of the destination icons.

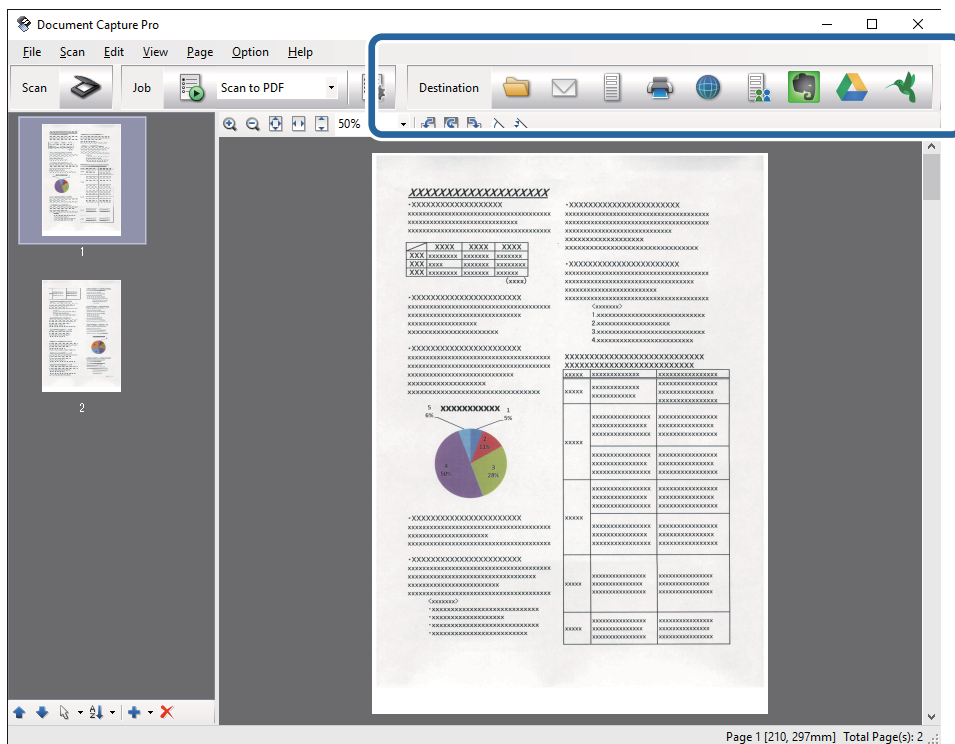

One of the following windows is displayed depending on the icon you selected; **Batch Save**, **Transfer Settings**, or another window.

Basic Scanning

Note:

- ❑ *If you want to upload to a cloud service, you need to set up your account with the cloud service in advance.*
- ❑ *If you want to use Evernote as the destination, download the Evernote application from the Evernote Corporation Website and install it before using this feature.*
- ❑ *On the **Batch Save** window or the **Transfer Settings** window, click **File Name & Separation Settings**, and then select **Apply job separation** to sort the documents into separate files by using a variety of detection methods such as barcodes or text in the scanned images.*

8. Make settings for each item in the window, and then click **Send** or **OK**.

9. Follow the on-screen instructions.

The scanned image is saved to a folder, attached to an email, uploaded to a cloud service, and so on depending on the function you selected.

Related Information

- ➔ [“Placing Originals” on page 25](#)
- ➔ [“Document Capture Pro / Document Capture” on page 17](#)
- ➔ [“Setting a Resolution That Suits the Scanning Purpose” on page 57](#)

Scanning Using Document Capture (Mac OS X)

This application allows you to perform various tasks such as saving the image to your computer, sending it by email, printing, and uploading to a server or a cloud service. You can register scanning settings for a job to simplify scanning operations. See the help for details on Document Capture.

Note:

Do not use the Fast User Switching function while using your scanner.

1. Place the original.

Basic Scanning

2. Start Document Capture.

Select **Finder > Go > Applications > Epson Software > Document Capture**.

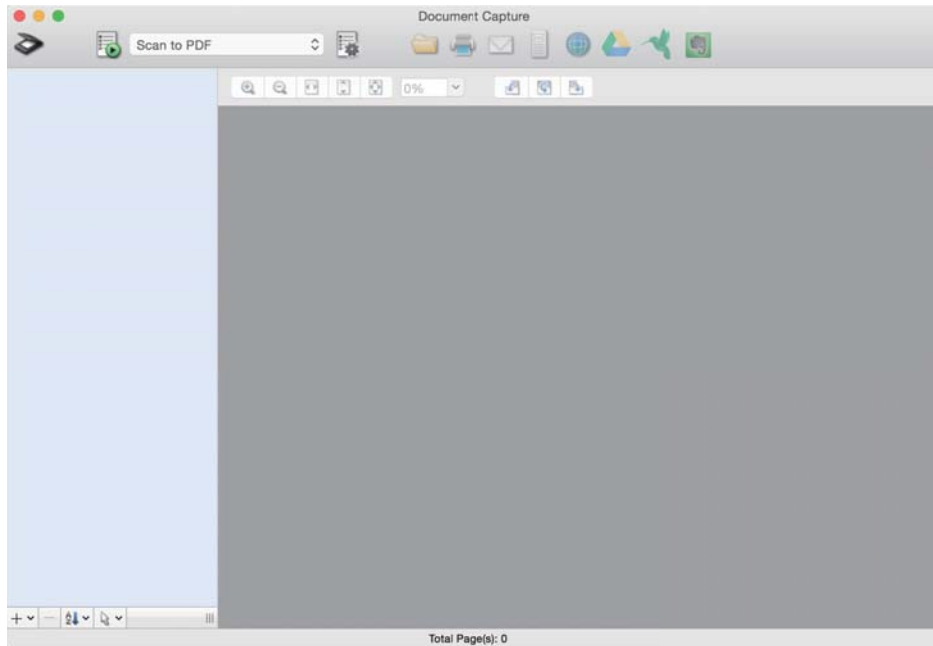

Note:

You may need to select the scanner you want to use from the scanners list.

3. Click .

The **Scan Settings** window is displayed.

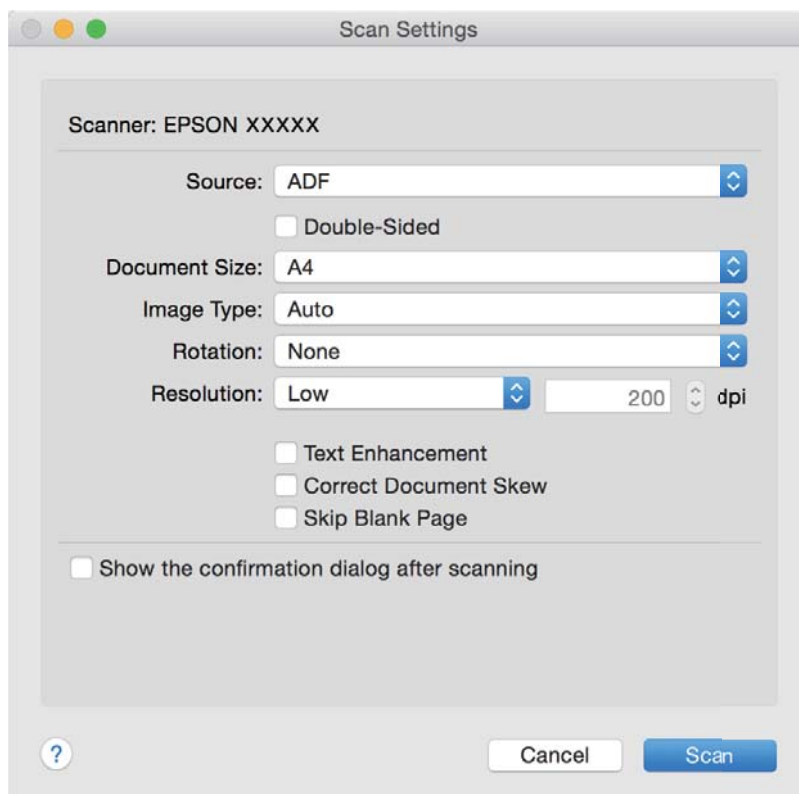

Basic Scanning

4. Make the following settings.

- Source:** Select the source where the original is placed.
- Document Size:** Select the size of the original you placed.
- Image Type:** Select the color you want to use to save the scanned image.
- Rotation:** Select the rotation angle depending on the original you want to scan.
- Resolution:** Select the resolution.

Note:

You can also adjust the image using following items.

- Text Enhancement:** Select to make blurred letters in the original clear and sharp.
- Correct Document Skew:** Select to correct the slant of the original.
- Skip Blank Page:** Select to skip blank pages if there are any in the originals.

5. Click **Scan**.

The scanned document is displayed in Document Capture.

6. Check the scanned images, and edit them if necessary.

7. When you have finished checking the image, click one of the destination icons.

One of the transfer settings windows is displayed depending on the icon you selected.

Note:

- If you want to upload to a cloud service, you need to set up your account with the cloud service in advance.*
- If you want to use Evernote as the destination, download the Evernote application from the Evernote Corporation Website and install it before using this feature.*

8. Make settings for each item in the window, and then click **Send** or **OK**.

9. Follow the on-screen instructions.

The scanned image is saved to a folder, attached to an email, uploaded to a cloud service, and so on depending on the function you selected.

Related Information

- ➔ [“Placing Originals” on page 25](#)
- ➔ [“Document Capture Pro / Document Capture” on page 17](#)
- ➔ [“Setting a Resolution That Suits the Scanning Purpose” on page 57](#)

Scanning Using a Scanner Button

You can scan using the button on your scanner.

Basic Scanning

Note:

- ❑ *Make sure that Epson Scan 2 is installed on your computer and the scanner is connected to your computer correctly.*
- ❑ *When Document Capture Pro (Windows) or Document Capture (Mac OS X) is installed on your computer, you can assign the job to a button on the scanner and run the job by pressing it.*

However, this is not available over a wireless connection.

- ❑ *When using a wireless connection, launch Epson Scan 2 on your computer before scanning.*

If a computer is connected to the scanner by USB while another computer is also connected to the scanner over a wireless connection and Epson Scan 2 is running on this computer, scanned images are saved to the wirelessly connected scanner when you press the scanner button.

1. Place the original.
2. Press the  button.

Note:

*When using Document Capture Pro (Windows) or Document Capture (Mac OS X), the product starts the job that was assigned in the **Job Settings** window.*

Related Information

- ➔ [“Placing Originals” on page 25](#)
- ➔ [“Buttons” on page 13](#)
- ➔ [“Document Capture Pro / Document Capture” on page 17](#)
- ➔ [“Scanning Using Specified Scanning Settings \(Job\)” on page 78](#)

Advanced Scanning

Scanning Different Sizes or Types of Originals One by One (Automatic Feeding Mode)

You can scan different sizes or types of originals one by one using Automatic Feeding Mode. In this mode, the scanner starts scanning automatically when originals are loaded in the ADF.

1. Start Epson Scan 2.
2. Select **Automatic Feeding Mode** on the **Main Settings** tab.

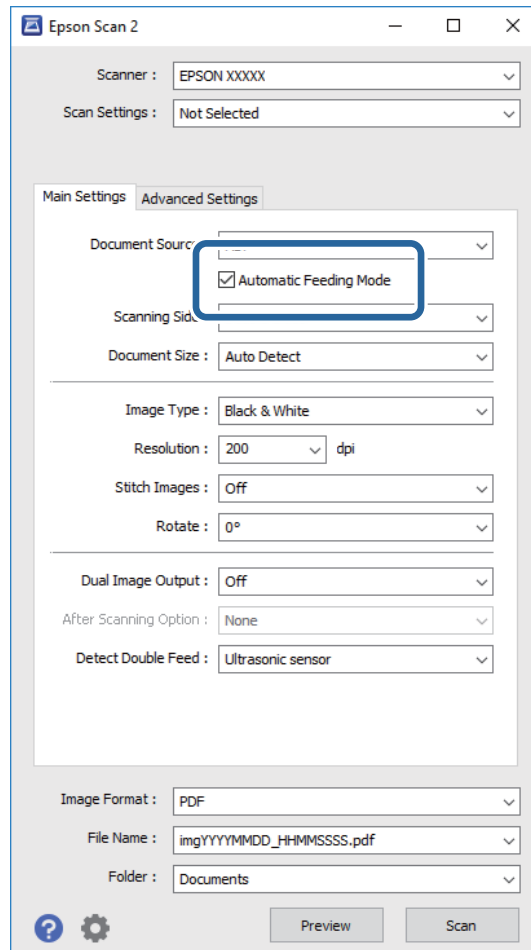

3. Make other settings for scanning on the Epson Scan 2 main window.
4. Click **Scan**.
Automatic Feeding Mode starts.

Advanced Scanning

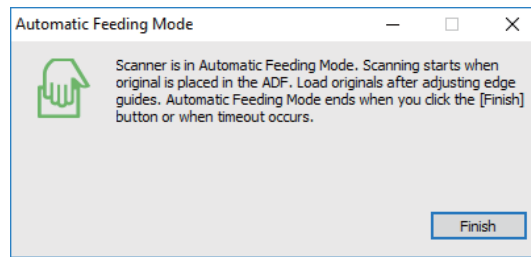

The  light on the scanner turns on, and the **Automatic Feeding Mode** window is displayed on your computer.



- Adjust the edge guides, and then place the original in the ADF.
Scanning starts automatically.

- After scanning stops, place the next original in the ADF.
Repeat this procedure until you have scanned all originals.

Note:

- If you want to scan originals that are detected as double feeds, for example plastic cards or envelopes, press the  button before placing the original to skip double feed detection.
- If you want to scan originals that are likely to jam, for example thin paper, press the  button before placing the original to slow down the scanning speed.

- After you have scanned all originals, press the  button on the scanner to close Automatic Feeding Mode.

Note:

- You can also close Automatic Feeding Mode by pressing **Finish** on the **Automatic Feeding Mode** window displayed on your computer.
- You can make timeout settings to finish **Automatic Feeding Mode**.

Select **Settings** on the **Document Source** list to open the **Document Source Settings** window. Set **Automatic Feeding Mode Timeout (minutes)** on the window.

The scanned image is saved to the folder you specified.

Related Information

➔ [“Placing Originals” on page 25](#)

Creating Scanned Images to Suit Your Needs

Image Adjustment Features

You can adjust scanned images using the features on the **Advanced Settings** tab in Epson Scan 2.

Except for a few features, you can check the adjustment results in the preview window.

Advanced Scanning

Note:

Some items may not be available depending on other settings you made.

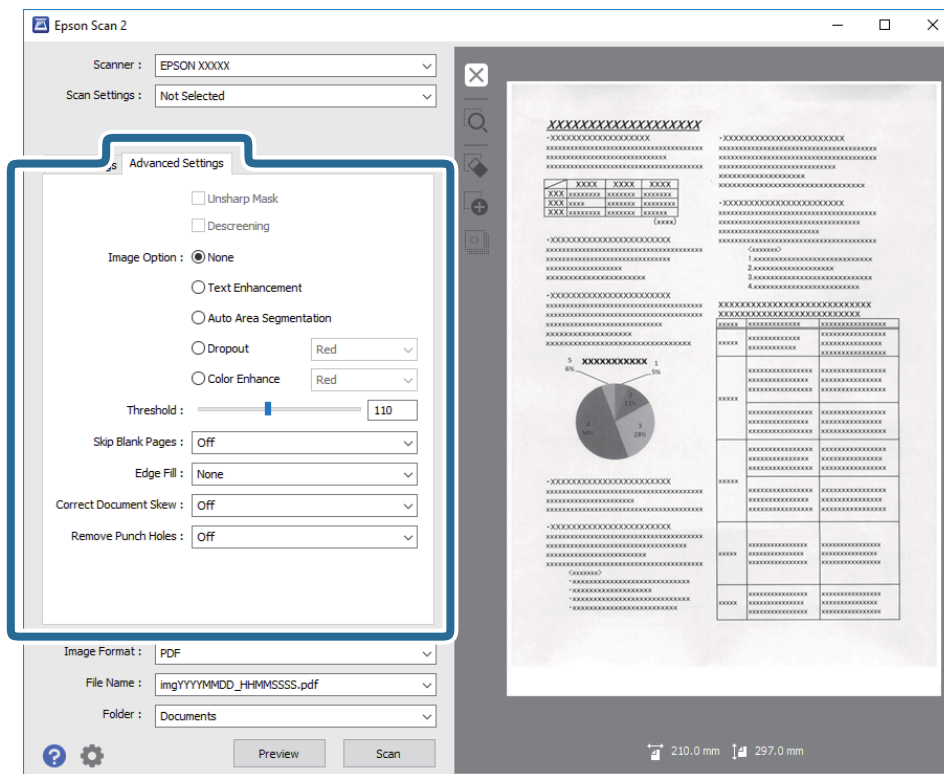

Related Information

- ➔ [“Unsharp Mask” on page 67](#)
You can enhance and sharpen the outlines of the image.
- ➔ [“Descreening” on page 67](#)
You can remove moiré patterns (web-like shadows) that appear when scanning printed paper such as a magazine.
- ➔ [“Text Enhancement” on page 68](#)
You can make blurred letters in the original clear and sharp. You can also reduce the offset or unevenness of the background.
- ➔ [“Auto Area Segmentation” on page 68](#)
You can make letters clear and images smooth when performing black and white scanning for a document that contains images.
- ➔ [“Dropout” on page 68](#)
You can remove the color specified from the scanned image, and then save it in grayscale or black and white. For example, you can erase marks or notes you wrote in the margins with color pen when scanning.
- ➔ [“Color Enhance” on page 69](#)
You can enhance the color specified for the scanned image, and then save it in grayscale or black and white. For example, you can enhance letters or lines that are in light colors.
- ➔ [“Brightness” on page 69](#)
You can adjust the brightness for the whole image.
- ➔ [“Contrast” on page 69](#)
You can adjust the contrast for the whole image. If you increase the contrast, the bright areas become brighter, and the dark areas become darker. On the other hand, if you lower the contrast, the differences between the bright and dark areas of the image are less defined.
- ➔ [“Gamma” on page 70](#)

Advanced Scanning

You can adjust the gamma (brightness of the intermediate range) for the whole image. If the image is too light or too dark, you can adjust the brightness.

➔ **“Threshold” on page 70**

You can adjust the border for monochrome binary (black and white). Increase the threshold, the black color area becomes larger. Decrease the threshold, the white color area becomes larger.

➔ **“Skip Blank Pages” on page 70**

You can skip blank pages if there are any in the originals.

➔ **“Edge Fill” on page 71**

You can remove the shadow created around the scanned image.

➔ **“Correct Document Skew” on page 71**

You can correct the slant of the original.

➔ **“Remove Punch Holes” on page 72**

You can remove the shadows of holes on the scanned image when scanning originals with punched holes.

Unsharp Mask

You can enhance and sharpen the outlines of the image.



Note:

*This feature is not available when selecting the **Main Settings** tab > **Image Type** > **Black & White**.*

Descreening

You can remove moiré patterns (web-like shadows) that appear when scanning printed paper such as a magazine.



To check for moiré patterns, display the image at 100 % (1:1). If the displayed image is zoomed out, the image appears rough and may look like it has moiré patterns.

Note:

- To use this feature, set the **Resolution** on the **Main Settings** tab to 600 dpi or less.
- This feature is not available when selecting the **Main Settings** tab > **Image Type** > **Black & White**.
- The effect of this feature cannot be checked in the preview window.
- This feature softens the sharpness of the scanned image.

Advanced Scanning

Image Option

You can select the effect for the scanned image.

Text Enhancement

You can make blurred letters in the original clear and sharp. You can also reduce the offset or unevenness of the background.



You can select the level of the effect when selecting the **Main Settings** tab > **Image Type** > **Color** or **Grayscale**.

Note:

To use this feature, set the **Resolution** on the **Main Settings** tab to 600 dpi or less.

Auto Area Segmentation

You can make letters clear and images smooth when performing black and white scanning for a document that contains images.



You can adjust the quality of the image part of the original from **Brightness** and **Contrast**.

Note:

- You can only make settings for this feature when selecting the **Main Settings** tab > **Image Type** > **Black & White**.
- To use this feature, set the **Resolution** on the **Main Settings** tab to 600 dpi or less.

Dropout

You can remove the color specified from the scanned image, and then save it in grayscale or black and white. For example, you can erase marks or notes you wrote in the margins with color pen when scanning.



Advanced Scanning

If you select **Customize** from the color list in **Dropout**, you can make settings for the color you want to remove while checking the preview window (for Windows only).

Note:

*This feature is not available when selecting the **Main Settings tab > Image Type > Auto or Color.***

Color Enhance

You can enhance the color specified for the scanned image, and then save it in grayscale or black and white. For example, you can enhance letters or lines that are in light colors.



If you select **Customize** from the color list in **Color Enhance**, you can make settings for the color you want to enhance while checking the preview window (for Windows only).

Note:

*This feature is not available when selecting the **Main Settings tab > Image Type > Auto or Color.***

Brightness

You can adjust the brightness for the whole image.



Note:

*This feature is not available depending on the settings on the **Main Settings tab > Image Type** or the settings on the **Advanced Settings tab.***

Contrast

You can adjust the contrast for the whole image. If you increase the contrast, the bright areas become brighter, and the dark areas become darker. On the other hand, if you lower the contrast, the differences between the bright and dark areas of the image are less defined.



Advanced Scanning

Note:

This feature is not available depending on the settings on the **Main Settings** tab > **Image Type** or the settings on the **Advanced Settings** tab.

Gamma

You can adjust the gamma (brightness of the intermediate range) for the whole image. If the image is too light or too dark, you can adjust the brightness.



Note:

This feature is not available depending on the settings on the **Main Settings** tab > **Image Type** or the settings on the **Advanced Settings** tab.

Threshold

You can adjust the border for monochrome binary (black and white). Increase the threshold, the black color area becomes larger. Decrease the threshold, the white color area becomes larger.

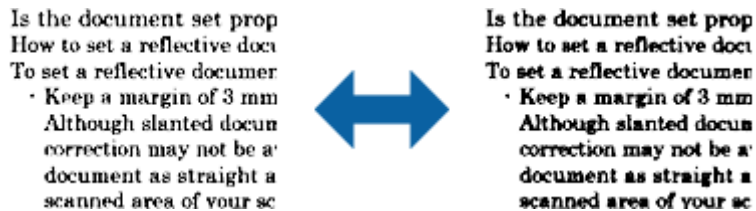

Note:

This feature may not be available depending on the settings on the **Main Settings** tab > **Image Type** or the settings on the **Advanced Settings** tab.

Skip Blank Pages

You can skip blank pages if there are any in the originals.

You can select the amount of blank page detection. If you set this to a high level, you can skip any originals with light colors or offset as blank pages.

If the result is not what you expected, select **Skip Blank Pages** > **Settings**, and then adjust **User Defined Level**. Select again **Skip Blank Pages** > **User Defined Level**.

Note:

- Some pages may be incorrectly skipped as blank pages.
- This feature is not available when scanning double-sided originals that are stitched.

Advanced Scanning

Edge Fill

You can remove the shadow created around the scanned image.

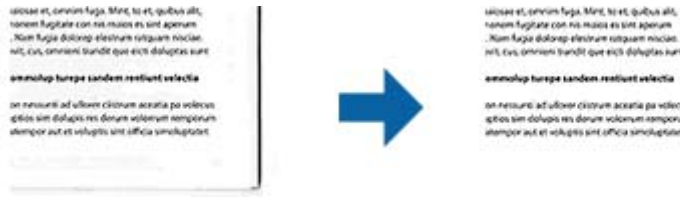

For double-sided scanning, the settings for the edge fill range are mirror-reversed for the back of the original.

If you select **Settings**, the **Edge Fill Level** screen is displayed, and you can adjust the edge fill ranges for the top, bottom, left, and right.

Note:

The effect of this feature cannot be checked in the preview window.

Correct Document Skew

You can correct the slant of the original.



Off

The slant of the original is not corrected.

Paper Skew

Corrects the slant of originals that are fed askew.

Contents Skew

Corrects the slant of the content of the original that was printed at an angle and so on.

Paper and Contents Skew

Corrects the slant of the original that is fed askew as well as the content of the original.

Note:

- When using this feature, areas that are fed askew are corrected using white.
- To use this feature, set the **Resolution** on the **Main Settings** tab to 600 dpi or less.
- This feature may not be able to correct documents that have been over skewed.
- The effect of this feature cannot be checked in the preview window.

Advanced Scanning

Remove Punch Holes

You can remove the shadows of holes on the scanned image when scanning originals with punched holes.

You can remove the shadows of round or square punch holes that are within a range of 20 mm (0.79 in.) from the edges of the original.



Note:

- This feature is only available when you are scanning white or light colored originals.
- Depending on the scanned originals, the shadows of the punch holes may not be removed.
- The effect of this feature cannot be checked in the preview window.

Editing Scanned Pages Using Epson Scan 2

You can edit pages of scanned images using the features on the **Main Settings** tab in Epson Scan 2.

Stitch Images

You can stitch the images on the front and rear when scanning both sides of the original. Select the layout for stitching the images.

Note:

This feature is available when you have selected **Double-Sided** in **Scanning Side**.

Rotate

You can rotate the original clockwise and scan it. Select the rotation angle depending on the original you want to scan.

Note:

If you select **Auto** and scan the original, the image is rotated by detecting the orientation of the text information. However, this may take some time depending on the image size, and so on.

Auto is only available if the EPSON Scan OCR component (Windows) or EPSON Scan 2 OCR component (Mac OS X) is installed.

Saving as a Searchable PDF

You can save the scanned image as a Searchable PDF. This is a PDF in which searchable text data is embedded.

Advanced Scanning

Note:

- Text on the originals is recognized using Optical Character Recognition (OCR), and then embedded in the scanned image.*
- This feature is only available when the EPSON Scan OCR component (Windows) or Epson Scan 2 OCR component (Mac OS X) is installed.*

1. Place the original.
2. Start Epson Scan 2.
3. Make settings for each item on the **Main Settings** tab.
4. Click **Preview**.
5. Place the ejected original again when using the ADF.
6. Check the preview, and make other settings on the **Advanced Settings** tab if necessary.
7. Select **Searchable PDF** from the **Image Format** list.
8. Select **Options** from the **Image Format** list to open the **Image Format Options** window.
9. Select the **Text** tab on the **Image Format Options** window.
10. Check that the language of the original is selected in the **Text Language** list.
11. Click **OK** to close the **Image Format Options** window.
12. Check the save file name displayed in **File Name**.
13. Select the save folder for the scanned image from the **Folder** list.
14. Click **Scan**.

The scanned image is saved as a Searchable PDF.

Related Information

- ➔ [“Scanning Using Epson Scan 2” on page 53](#)
- ➔ [“Placing Originals” on page 25](#)
- ➔ [“Text is Not Recognized Correctly when Saving as a Searchable PDF” on page 111](#)

Saving as an Office Format File (for Windows Only)

You can save the scanned image as a Microsoft® Office format file using Document Capture Pro.

You can select the following formats.

- Microsoft® Word (.docx)
- Microsoft® Excel® (.xlsx)
- Microsoft® PowerPoint® (.pptx)

Note:

This feature is only available when the EPSON Scan OCR component is installed.

Advanced Scanning

1. Place the original.
2. Start Document Capture Pro.
3. Click  .
The **Scan** window is displayed.
4. Make the scanning settings, and then click **Scan**.
5. Check the scanned images, and edit them if necessary.
6. When you have finished checking the image, click one of the destination icons.

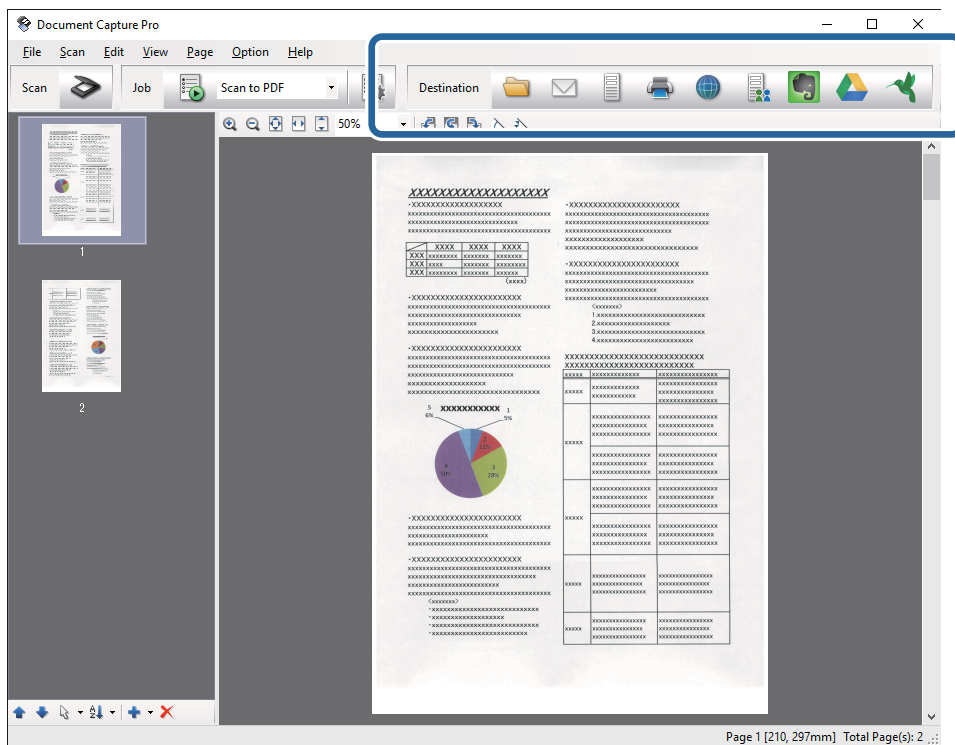

The **Batch Save**, **Transfer Settings**, or another window opens.

7. Select the Office format file you want to save as from the **File Type** list.
8. Click **Options** to display the **Detailed Settings** window.
9. Make settings for each item, and then click **OK** to close the **Detailed Settings** window.
10. Make other settings if necessary, and then click **Send** or **OK**.
The scanned image is saved as an Office format file.

Related Information

- ➔ [“Scanning Using Document Capture Pro \(Windows\)” on page 57](#)
- ➔ [“Placing Originals” on page 25](#)

Various Types of Saving and Transferring

Sorting and Saving Scanned Images into a Separate Folder (for Windows Only)

You can sort scanned images automatically and save them to a separate folder using Document Capture Pro.

To sort scanned images, you can use a variety of detection methods such as blank pages inserted between the originals or barcodes on the originals.

1. Place the originals including indicators, such as blank pages, between the pages where you want to separate the scanned images.
2. Start Document Capture Pro.
3. Click .
The **Scan** window is displayed.
4. Make the scanning settings, and then click **Scan**.
5. Check the scanned images, and edit them if necessary.
6. When you have finished checking the image, select the destination.
The **Batch Save** window or the **Transfer Settings** window is displayed.
7. Click **File Name & Separation Settings**.
8. Select **Apply job separation**, and then click **Separation Settings**.
9. Select the separation method and the method for specifying the folder name on the **Job Separation Settings** window, and then click **OK**.
10. Make other settings on the **File Name & Separation Settings** window, and then click **OK**.
11. Make other settings on the **Batch Save** window or the **Transfer Settings** window, and then click **OK** or **Send**.
Scanned images are saved separately based on the separation method selected.

Related Information

- ➔ [“Scanning Using Document Capture Pro \(Windows\)” on page 57](#)
- ➔ [“Placing Originals” on page 25](#)

Scanning to a Cloud Service

You can upload scanned images to cloud services using Document Capture Pro (Windows) or Document Capture (Mac OS X).

Advanced Scanning

Note:

- Create a cloud service account before using this function.
- If you want to use Evernote as the destination, download the Evernote application from the Evernote Corporation Website, and then install it before using this feature.

1. Place the original.
2. Start Document Capture Pro (Windows) or Document Capture (Mac OS X).
3. Click  .
The **Scan** window is displayed.
4. Make the scanning settings, and then click **Scan**.
5. Check the scanned images, and edit them if necessary.
6. When you have finished checking the image, click the destination icon.

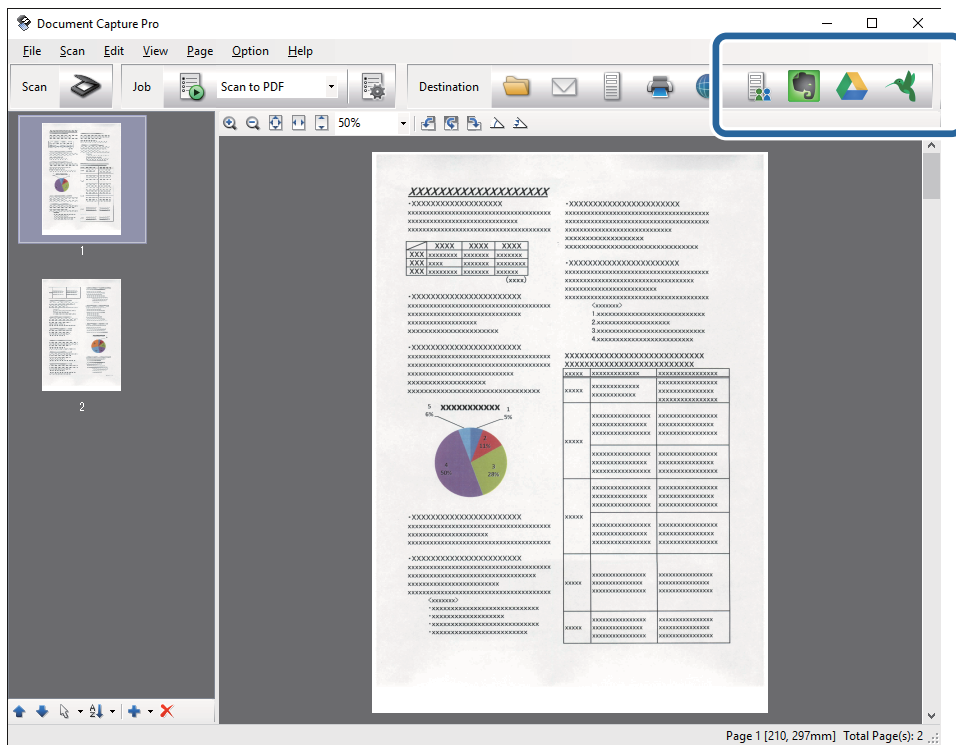

The **Transfer Settings** window is displayed.



7. Make settings for each item, and then click **Send**.
The scanned Image is sent to the selected cloud service.

Related Information

- ➡ “Scanning Using Document Capture Pro (Windows)” on page 57
- ➡ “Scanning Using Document Capture (Mac OS X)” on page 60
- ➡ “Placing Originals” on page 25

Uploading to an FTP Server

You can upload scanned images to an FTP server using Document Capture Pro (Windows) or Document Capture (Mac OS X).

1. Place the original.
2. Start Document Capture Pro (Windows) or Document Capture (Mac OS X).
3. Click .
The **Scan** window is displayed.
4. Make the scanning settings, and then click **Scan**.
5. Check the scanned images, and edit them if necessary.
6. When you have finished checking the image, click the  icon.
The **Transfer Settings** window is displayed.
7. Make settings for each item, and then click **Send**.

Note:

Contact your network administrator for the settings of your FTP server.



The scanned image is sent to your FTP server.

Related Information

- ➔ [“Scanning Using Document Capture Pro \(Windows\)” on page 57](#)
- ➔ [“Scanning Using Document Capture \(Mac OS X\)” on page 60](#)
- ➔ [“Placing Originals” on page 25](#)

Attaching Scanned Images to an Email

You can attach scanned images directly to an email using Document Capture Pro (Windows) or Document Capture (Mac OS X).

1. Place the original.
2. Start Document Capture Pro (Windows) or Document Capture (Mac OS X).
3. Click .
The **Scan** window is displayed.
4. Make the scanning settings, and then click **Scan**.
5. Check the scanned images, and edit them if necessary.
6. When you have finished checking the image, click the  icon.
The **Batch Save** window is displayed.

Advanced Scanning

7. Make settings for each item, and then click **OK**.

The email client on your computer starts automatically, and the scanned image is attached to an email.

Related Information

- ➔ [“Scanning Using Document Capture Pro \(Windows\)” on page 57](#)
- ➔ [“Scanning Using Document Capture \(Mac OS X\)” on page 60](#)
- ➔ [“Placing Originals” on page 25](#)



Printing Scanned Images

You can print scanned images directly from an Epson printer connected to the computer.

Note:

Before using this feature, check the following.

- The Epson printer is connected to the same computer to which the scanner is connected.*
- The printer driver is correctly installed on the computer.*

1. Place the original.
2. Start Document Capture Pro (Windows) or Document Capture (Mac OS X).
3. Click  .
The **Scan** window is displayed.
4. Make the scanning settings, and then click **Scan**.
5. Check the scanned images, and edit them if necessary.
6. When you have finished checking the image, click the  icon.

The **Print Settings** window opens.

7. Make settings for each item, and then click **OK**.

The scanned image is printed from the printer.

Related Information

- ➔ [“Scanning Using Document Capture Pro \(Windows\)” on page 57](#)
- ➔ [“Scanning Using Document Capture \(Mac OS X\)” on page 60](#)
- ➔ [“Placing Originals” on page 25](#)

Scanning Using Specified Scanning Settings (Job)

You can create a "Job" which is a set of specified scanning settings such as the sorting method, saving format, destination, and so on.

You can set the job in Document Capture Pro (Windows) or Document Capture (Mac OS X).

Advanced Scanning

You can also assign the job to a button on the scanner, and run the job by pressing it. (Only when using a USB connection.)

Note:



Document Capture Pro and Document Capture do not support scanning from the button over a wireless connection.

Setting a Job

1. Start Document Capture Pro (Windows) or Document Capture (Mac OS X).
2. Click the  (**Manage Job**) icon on the main window.
The **Job Management** window is displayed.
3. On the **Job Management** window, click **Add** (Windows) or the + icon (Mac OS X).
The **Job Settings** window opens.
4. Make the job settings on the **Job Settings** window.
 - Job Name:** Enter a name for the job.
 - Scan** tab: Set scanning settings on the tab.
 - Output** tab: Set the output format of the scanned image on the tab.
 - Destination:** Select the destination of the scanned image.
5. Click **OK** to close the **Job Settings** window.
6. Click **OK** on the **Job Management** window.
The job is set in the Document Capture Pro or Document Capture.

Assigning a Job to the Scanner Button

You can assign a job to the scanner's button, and run the job by pressing the button.

1. Start Document Capture Pro (Windows) or Document Capture (Mac OS X).
2. Click the  (**Manage Job**) icon on the main window.
The **Job Management** window is displayed.
3. Click **Event Settings** on the **Job Management** window (Windows), or click the  icon at the bottom of the screen (Mac OS X).
4. Click the job name to select the job you want to assign from the pull-down menu.
5. Click **OK** on the **Job Management** window.
The job is assigned to the scanner button.

Related Information

➔ [“Buttons” on page 13](#)

Advanced Scanning

- ➔ “Scanning Using a Scanner Button” on page 62
- ➔ “Placing Originals” on page 25

Scanning Business Cards Using Presto! BizCard

You can scan business cards and convert them to editable text using Presto! BizCard.

See the software’s help for more information on using the software and its functions. To display the help, select it from the software’s help menu.

1. Place the business card on the scanner.
2. Start Presto! BizCard.
 - Windows 10
Click the start button, and then select **All apps > NewSoft > Presto! BizCard**.
 - Windows 8.1/Windows 8
Enter the application name in the search charm, and then select the displayed icon.
 - Windows 7/Windows Vista/Windows XP
Click the start button, and then select **All Programs or Programs > NewSoft > Presto! BizCard**.
 - Mac OS X
Select **Go > Applications > NewSoft > Presto! BizCard**.

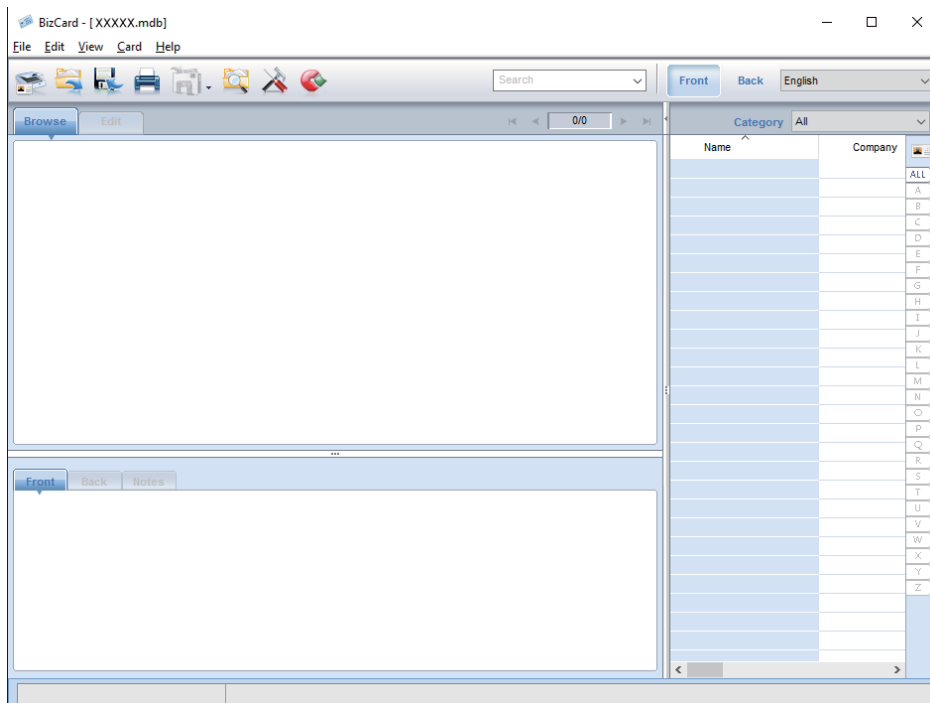

3. Click the  icon at the top-left of the window.
The Epson Scan 2 window opens.

Advanced Scanning

4. Set each item on the Epson Scan 2 window, and then scan.

The business card is scanned and converted into editable text in the Presto! BizCard window.

Related Information

- ➔ [“Presto! BizCard” on page 17](#)
- ➔ [“Placing Originals” on page 25](#)

Scanning from Smart Devices Using NFC Tag

You can connect your smart device and the scanner automatically using the Epson DocumentScan application and the NFC (Near Field Communication) function.

This feature is available for smart devices running Android 4.0 or later and that support NFC.

Before using this feature, enable the NFC function on your smart device.

Note:

- ❑ *The location of the NFC antenna varies depending on the smart device. See the documentation provided with your smart device for more details.*
- ❑ *If the scanner does not communicate with the smart device even after touching it to the tag, try adjusting the position of the smart device and touch it to the tag again.*
- ❑ *If there are obstacles such as metal between the scanner's NFC tag and the NFC antenna of the smart device, the scanner may not be able to communicate with the smart device.*
- ❑ *If the scanner is already connected to the Wi-Fi network before using this feature, your smart device will be connected to the scanner using this network. If not, the scanner and your smart device will be connected in AP mode. In AP mode, you can connect up to four devices to the scanner at the same time.*

1. Place the original.
2. Make sure that Epson DocumentScan is installed on your smart device.

If not, touch the NFC tag antenna of the smart device to the scanner's NFC tag. Install Epson DocumentScan on the displayed application page.

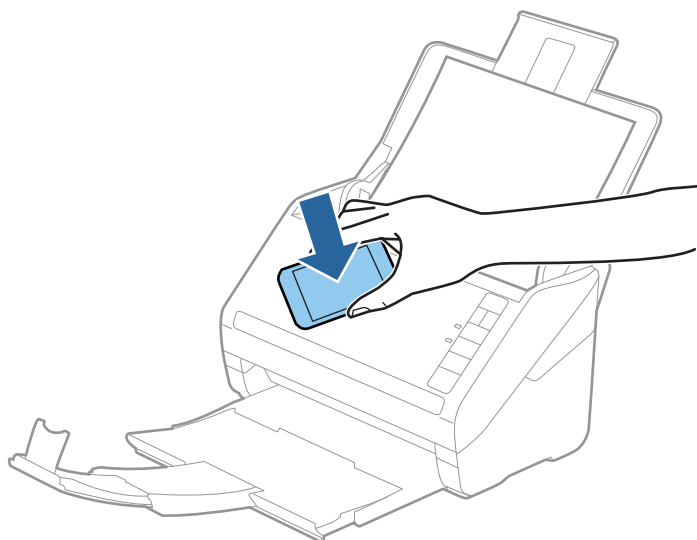

Advanced Scanning

3. Touch the NFC antenna of your smart device to the scanner's NFC tag.
Epson DocumentScan starts, and the scanner and the smart device are connected automatically.
4. Follow the Epson DocumentScan on-screen instructions for information on scanning.

Related Information

- ➔ [“Buttons” on page 13](#)
- ➔ [“Placing Originals” on page 25](#)

Network Settings

Network Connection Types

Wi-Fi Connection

Connect the scanner and the computer or smart device to the access point. This is the typical connection method for home or office networks where computers are connected by Wi-Fi through the access point.

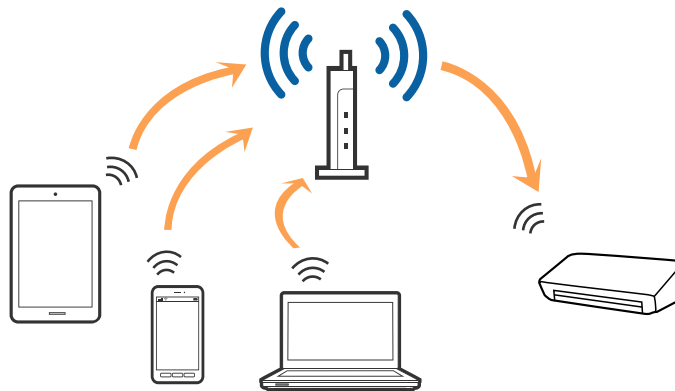

Related Information

- ➔ [“Connecting to a Computer” on page 84](#)
- ➔ [“Connecting to a Smart Device” on page 86](#)
- ➔ [“Making Wi-Fi Settings from the Control Panel” on page 86](#)

AP Mode Connection

Use this connection method when you are not using Wi-Fi at home or at the office, or when you want to connect the scanner and the smart device directly. In this mode, the scanner acts as an access point and you can connect up to four devices to the scanner without having to use a standard access point. However, devices directly connected to the scanner cannot communicate with each other through the scanner.

Network Settings

Note:

AP mode is a connection method designed to replace Ad Hoc mode.

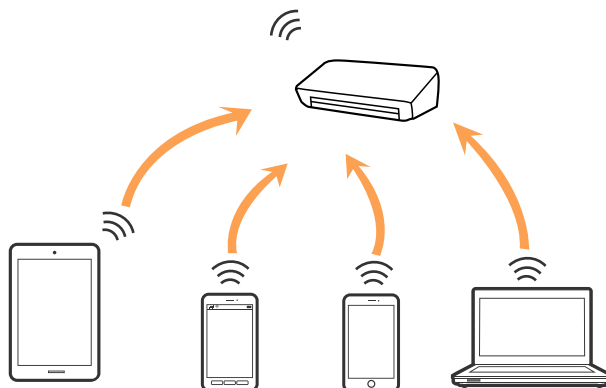

The scanner can be connected by Wi-Fi and AP mode simultaneously. However, if you start a network connection in AP mode when the scanner is connected by Wi-Fi, the Wi-Fi is temporarily disconnected.

Related Information

➔ [“Making AP Mode Settings” on page 87](#)

Connecting to a Computer

We recommend using the installer to connect the scanner to a computer. You can run the installer using one of the following methods.

- Setting up from the website

Access the following website, and then enter the product name.

<http://epson.sn>

Go to **Setup**, and then click **Download** in the download and connect part. Click or double-click the downloaded file to run the installer. Follow the on-screen instructions.

- Setting up using the software disc (only for the models that come with a software disc and users with computers with disc drives.)

Insert the software disc into the computer, and then follow the on-screen instructions.

Selecting the Connection Methods

Follow the on-screen instructions until the following screen is displayed and then select the connection method of the scanner to the computer.

Network Settings

Windows

Select the connection type and then click **Next**.

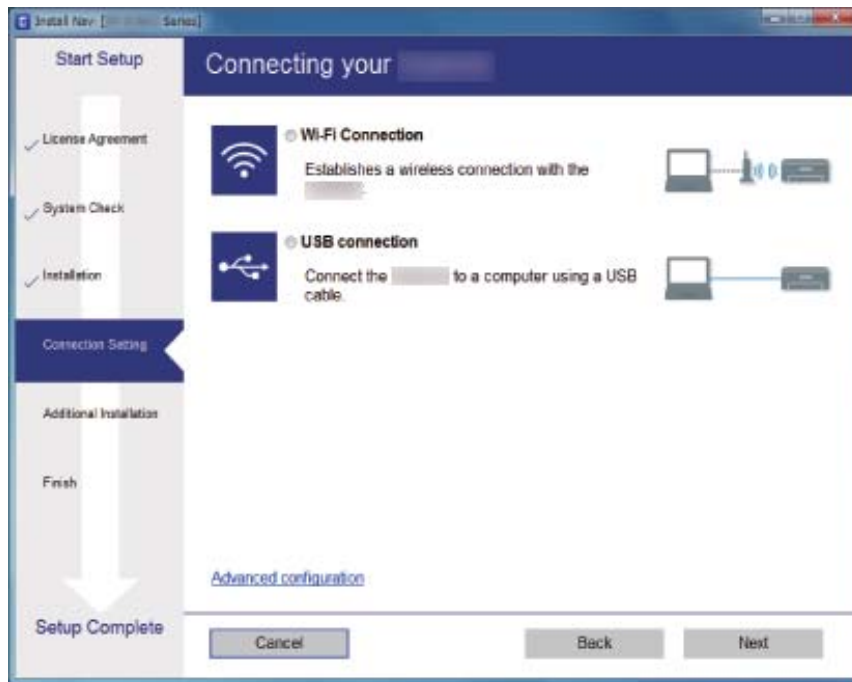

Mac OS X

Select the connection type.



Follow the on-screen instructions. The necessary software is installed.

Connecting to a Smart Device

You can use the scanner from a smart device when you connect the scanner to the same Wi-Fi network (SSID) as the smart device. To use the scanner from a smart device, set up from Epson DocumentScan.

Note:

- ❑ *If you want to connect a computer and a smart device to the scanner at the same time, we recommend connecting the computer first.*
- ❑ *You can install Epson DocumentScan from App Store or Google Play.*

Making Wi-Fi Settings from the Control Panel

You can make network settings from the scanner's control panel. After connecting the scanner to the network, connect to the scanner from the device that you want to use (computer, smart phone, tablet, and so on.)

Making Wi-Fi Settings by Push Button Setup (WPS)

You can automatically set up a Wi-Fi network by pressing a button on the access point. If the following conditions are met, you can set up by using this method.

- ❑ The access point is compatible with WPS (Wi-Fi Protected Setup).
- ❑ The current Wi-Fi connection was established by pressing a button on the access point.





Note:

If you cannot find the button or you are setting up using the software, see the documentation provided with the access point.

1. Hold down the [WPS] button on the access point until the security light flashes.





If you do not know where the [WPS] button is, or there are no buttons on the access point, see the documentation provided with your access point for details.

2. Press the  button on the scanner's control panel until the  light flashes blue (approximately 3 seconds).
The connection setting starts. The  light and  light flash alternately.
The  light is lit blue when connection is complete.

Network Settings

Note:



Connection fails when the  light turns on. After releasing the error by pressing the  button, restart the access point, move it closer to the scanner, and then try again.

Related Information

- ➔ [“Basic Scanning” on page 53](#)
- ➔ [“Advanced Scanning” on page 64](#)
- ➔ [“Network Problems” on page 113](#)

Making Wi-Fi Settings by PIN Code Setup (WPS)



You can automatically connect to an access point by using a PIN code. You can use this method to set up if an access point is capable of WPS (Wi-Fi Protected Setup). Use a computer to enter a PIN code into the access point.

1. Press the  button and the  button on the scanner's control panel simultaneously until  light flashes in blue (approximately 3 seconds).
2. Use your computer to enter the PIN code (an eight-digit number) on the label stuck to the scanner into the access point within two minutes.

The connection setting starts. The  light and  light flash alternately.

The  is lit blue when connection is complete.

Note:

- See the manual provided with your access point for details on entering a PIN code.
- Connection fails when the  light turns on. After releasing the error by pressing the  button, restart the access point, move it closer to the scanner, and then try again.

Related Information

- ➔ [“Basic Scanning” on page 53](#)
- ➔ [“Advanced Scanning” on page 64](#)
- ➔ [“Network Problems” on page 113](#)



Making AP Mode Settings

This method allows you to connect the scanner directly to devices without an access point. The scanner acts as an access point.

 **Important:**

When you connect from a smart device to the scanner using the AP mode connection, the scanner is connected to the same Wi-Fi network (SSID) as the smart device and communication is established between them. Since the smart device is automatically connected to other connectable Wi-Fi networks if the scanner is turned off, it is not connected to the previous Wi-Fi network again if the scanner is turned on. Connect to the scanner's SSID in AP mode from the smart device again. If you do not want to connect every time you turn the scanner on or off, we recommend using a Wi-Fi network by connecting the scanner to an access point.

Network Settings

1. Press the  button on the scanner's control panel.
The AP light is lit blue when AP mode connection is enabled.
2. Connect from the smart device or computer to the scanner using the scanner's SSID and password.

Note:

- You can check the SSID and password on the label stuck to the scanner.
- See the documentation provided with your smart device or computer for the operating instructions.

Related Information

- ➔ [“Basic Scanning” on page 53](#)
- ➔ [“Advanced Scanning” on page 64](#)
- ➔ [“Network Problems” on page 113](#)

Checking the Network Status Using Network Light

You can check the network connection status using the network light on the scanner's control panel.

Related Information

- ➔ [“Lights” on page 14](#)
- ➔ [“Error Indicators” on page 15](#)

Replacing or Adding New Access Points

If the SSID changes due to the replacement of an access point, or an access point is added and a new network environment is established, re-set the Wi-Fi settings.

Related Information

- ➔ [“Changing the Connection Method to a Computer” on page 88](#)

Changing the Connection Method to a Computer

Using the installer and re-set up in a different connection method.

- Setting up from the website

Access the following website, and then enter the product name.

<http://epson.sn>

Go to **Setup**, and then click **Download** in the download and connect part. Click or double-click the downloaded file to run the installer. Follow the on-screen instructions.

- Setting up using the software disc (only for the models that come with a software disc and users with computers with disc drives.)

Insert the software disc into the computer, and then follow the on-screen instructions.

Network Settings

Selecting Change the Connection Methods

Follow the on-screen instructions until the following screen is displayed.

❑ Windows

Select **Change or re-set the connection method** on the Select Software Installation screen, and then click **Next**.

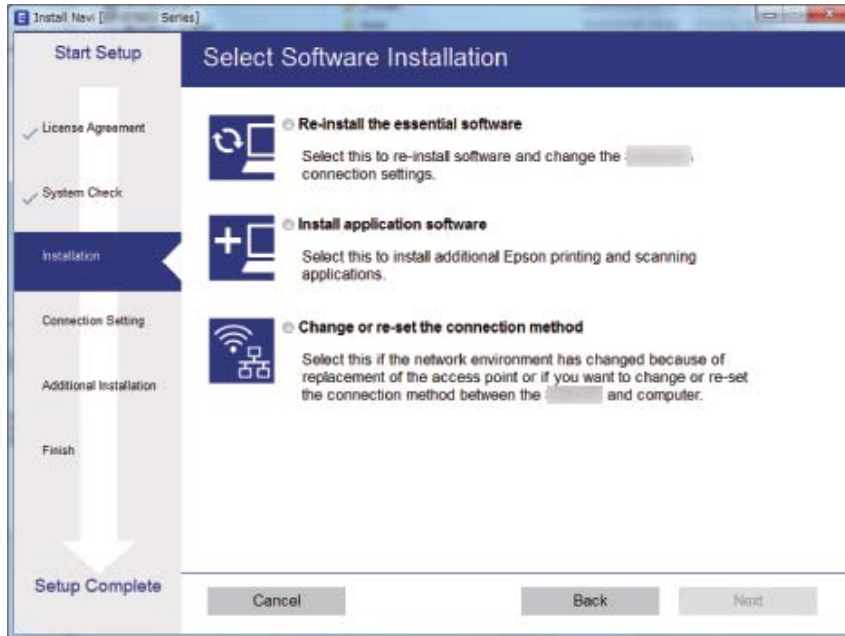

❑ Mac OS X

Select how you want to connect the scanner to your computer.





Disabling the Network Setting from the Control Panel

You can disable the network settings.

Network Settings

1. Press the  button for more than 3 seconds to disable a Wi-Fi and AP mode connection.







The  light and  light turn off when these are disabled.

Note:

Press the  button to re-connect Wi-Fi and AP mode.

Restoring the Network Settings from the Control Panel

You can restore all network settings to their defaults.

1. Turn the scanner off.
2. While holding down the  button, press the  button until  light and  light turn on simultaneously.
The  light and  light flash alternately and then turn off when restoration is complete.

Maintenance

Cleaning Outside the Scanner

Wipe off any stains on the outer case with a dry cloth or a cloth dampened with mild detergent and water.

**Important:**

- Never use alcohol, thinner, or any corrosive solvent to clean the scanner. Deformation or discoloration may occur.
- Do not let water get inside the product. This could cause a malfunction to occur.
- Never open the scanner case.

1. Press the  button to turn off the scanner.
2. Unplug the AC adapter from the scanner.
3. Clean the outer case with a cloth dampened with mild detergent and water.

Cleaning Inside the Scanner

After using the scanner for a while, paper and room dust on the roller or the glass part inside the scanner may cause paper feed or scanned image quality problems. Clean the inside of the scanner every 5,000 scans. You can check the latest number of scans in Epson Scan 2 Utility.

Use a genuine Epson cleaning kit for stains. Use a small amount of the cleaner on the cleaning cloth to remove the stains. Next, wipe them with cleaning cloth without any cleaner, or with a dry cloth.

**Important:**

- Never use alcohol, thinner, or any corrosive solvent to clean the scanner. Deformation or discoloration may occur.
- Never spray any liquid or lubricant on the scanner. Damage to equipment or circuits may cause abnormal operations.
- Never open the scanner case.

1. Press the  button to turn off the scanner.
2. Unplug the AC adapter from the scanner.

Maintenance

3. Pull the cover open lever and open the scanner cover.

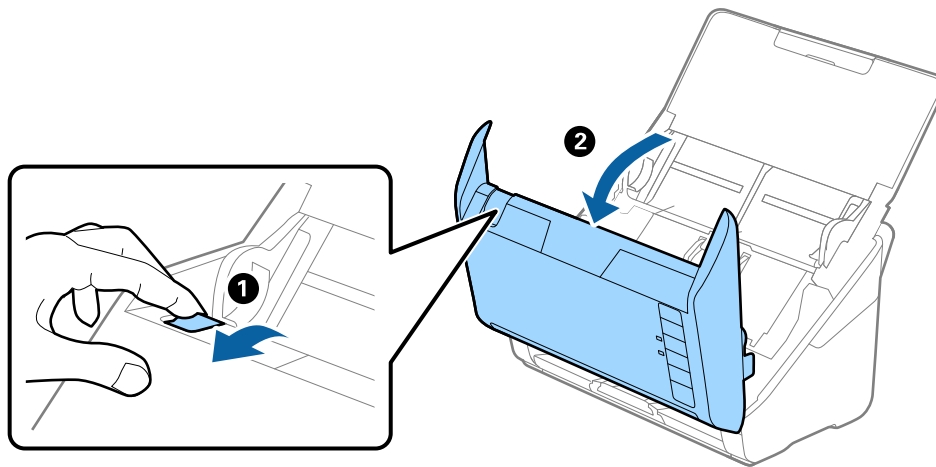

4. Wipe off any stains on the plastic roller and glass surface at the bottom inside of the scanner cover using a soft cloth or a genuine Epson cleaning kit.

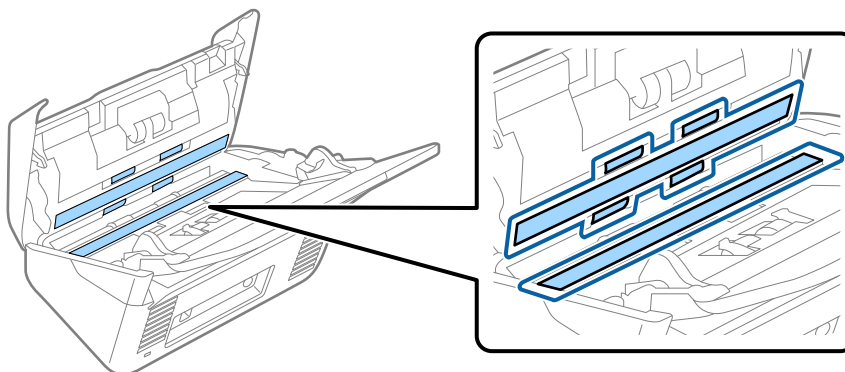

! **Important:**

- Do not place too much force on the glass surface.
- Do not use a brush or a hard tool. Any scratches on the glass may affect the scan quality.
- Do not spray cleaner directly onto the glass surface.

5. Wipe off any stains on the sensors with a cotton swab.

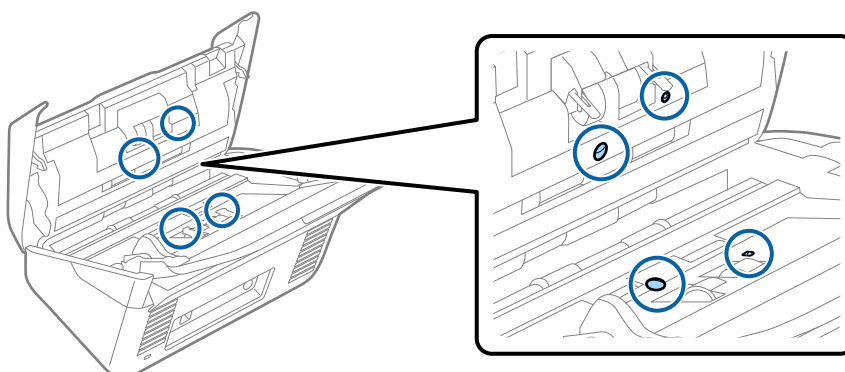

Maintenance



Important:

Do not use liquid such as a cleaner on a cotton swab.

6. Open the cover, and then remove the separation roller.
See “Replacing the Roller Assembly Kit” for more details.

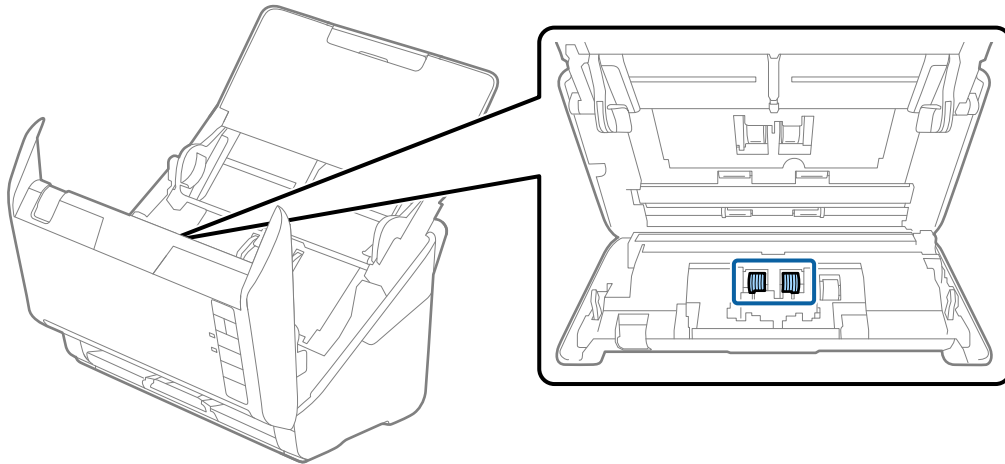

7. Wipe off any stains on the separation roller using a soft cloth or a genuine Epson cleaning kit.

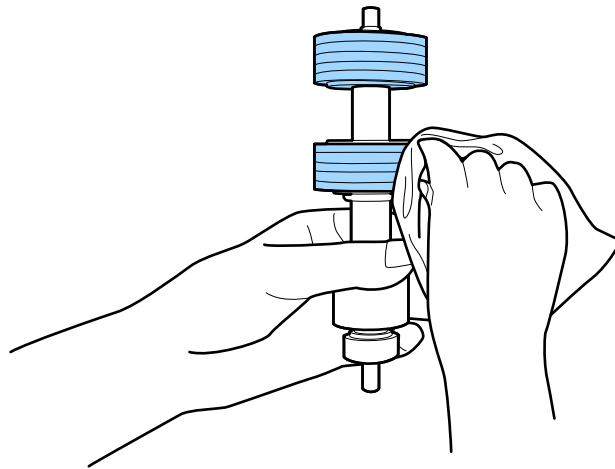

Maintenance

8. Open the cover, and then remove the pickup roller.
See “Replacing the Roller Assembly Kit” for more details.

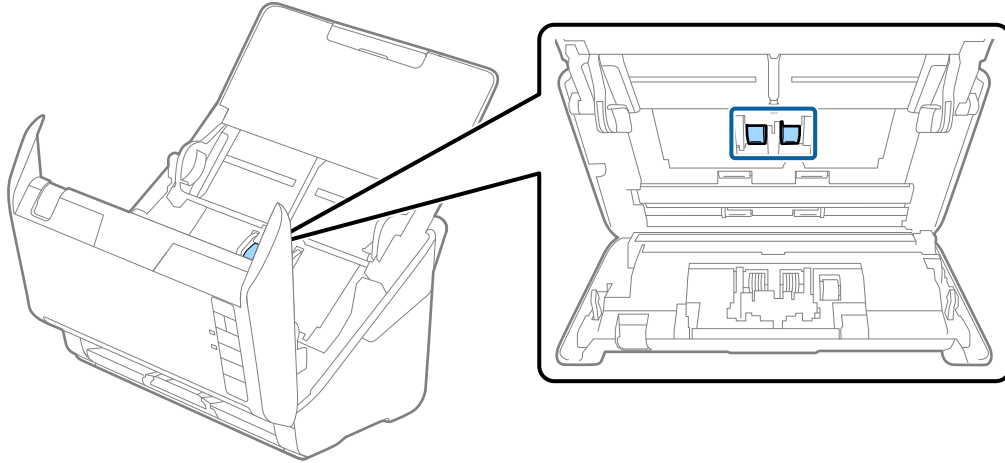

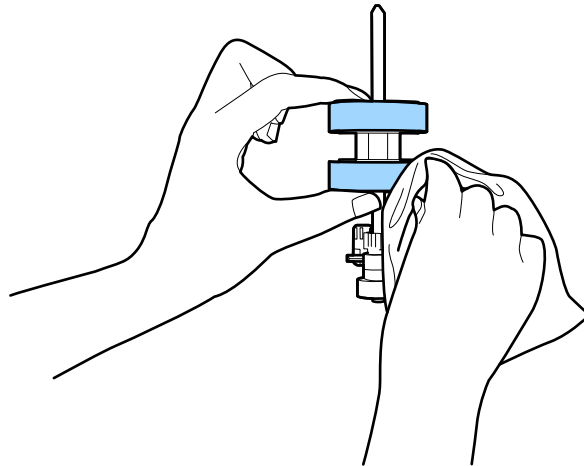

9. Wipe off any stains on the pickup roller using a soft cloth or a genuine Epson cleaning kit.



10. Plug in the AC adapter, and then turn on the scanner.

Maintenance

11. Press the  button for more than two seconds while opening the scanner cover. The rollers on the bottom move momentarily, and then the scanner enters cleaning mode. The rollers rotate a bit each time you press the  button. Press the  button to move the rollers, and then wipe the surface of the rollers with a soft cloth. Repeat this steps several times.

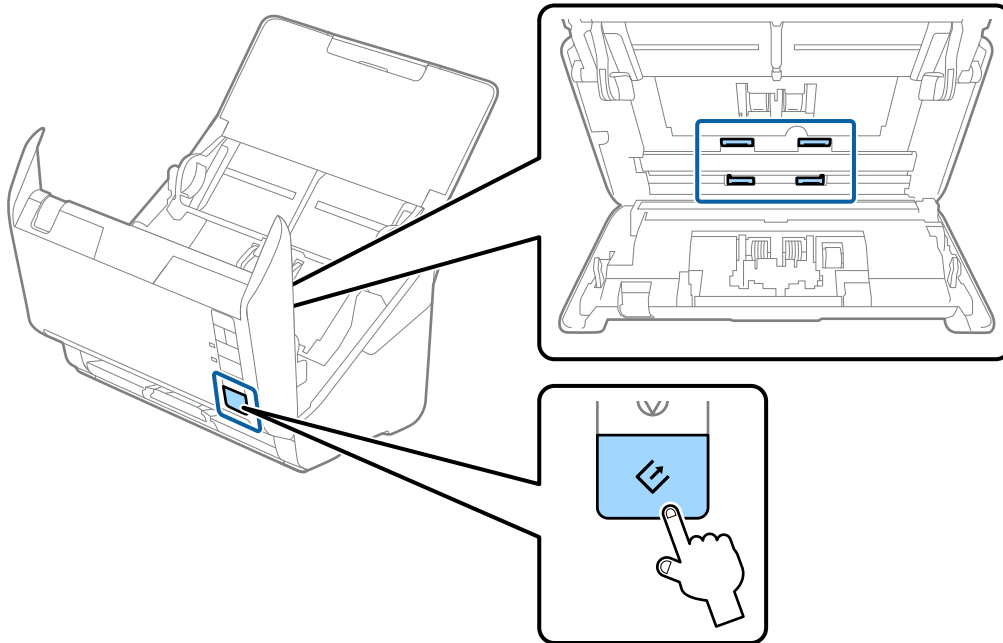
**Caution:**

Be careful not to get your hands or hair caught in the mechanism when operating the roller. This could cause an injury.

12. Close the scanner cover.
The scanner exits cleaning mode.

Related Information

- ➔ [“Cleaning Kit Codes” on page 20](#)
- ➔ [“Replacing the Roller Assembly Kit” on page 96](#)

Replacing the Roller Assembly Kit

The roller assembly kit (the pickup roller and the separation roller) needs to be replaced when the number of scans exceeds the Life Cycle of the rollers. When a replacement message is displayed on your computer, follow the steps below to replace it.

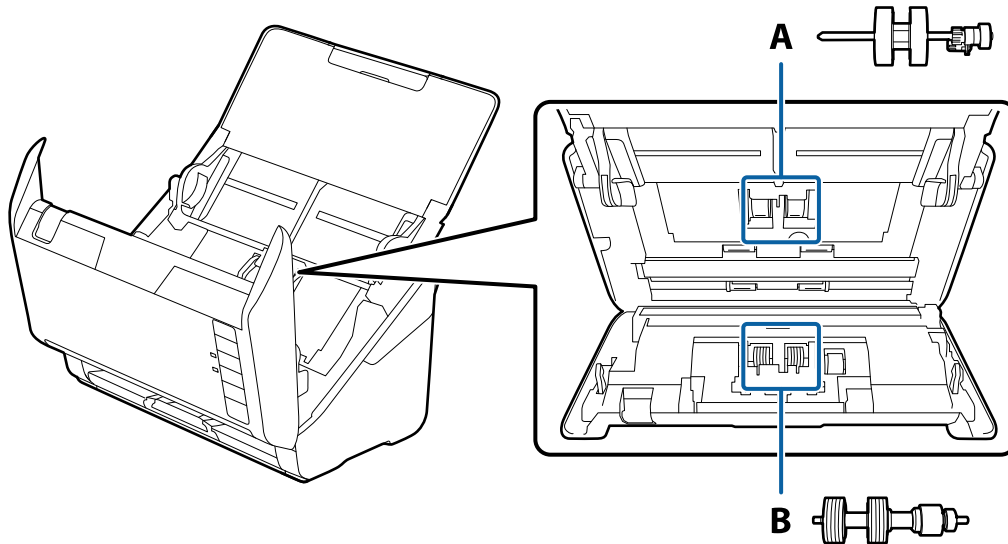

A: pickup roller, B: separation roller

1. Press the  button to turn off the scanner.
2. Unplug the AC adapter from the scanner.
3. Pull the cover open lever and open the scanner cover.

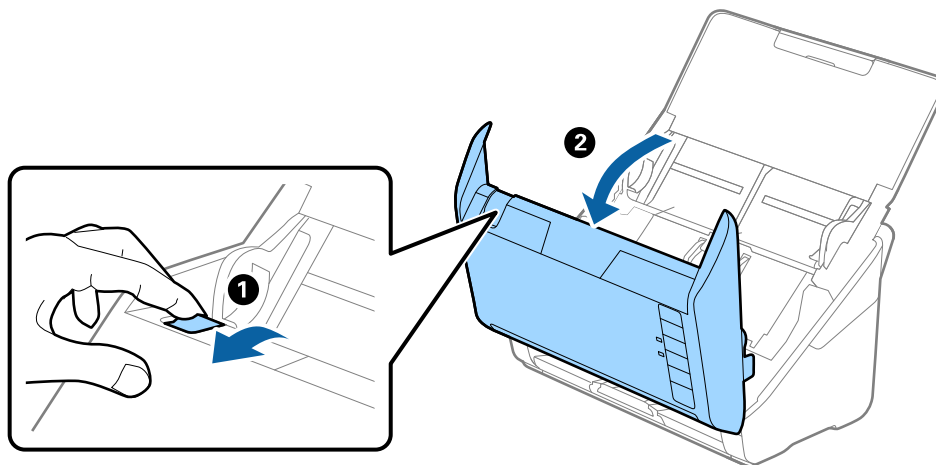

Maintenance

4. Open the cover of the pickup roller, and then slide and remove it.

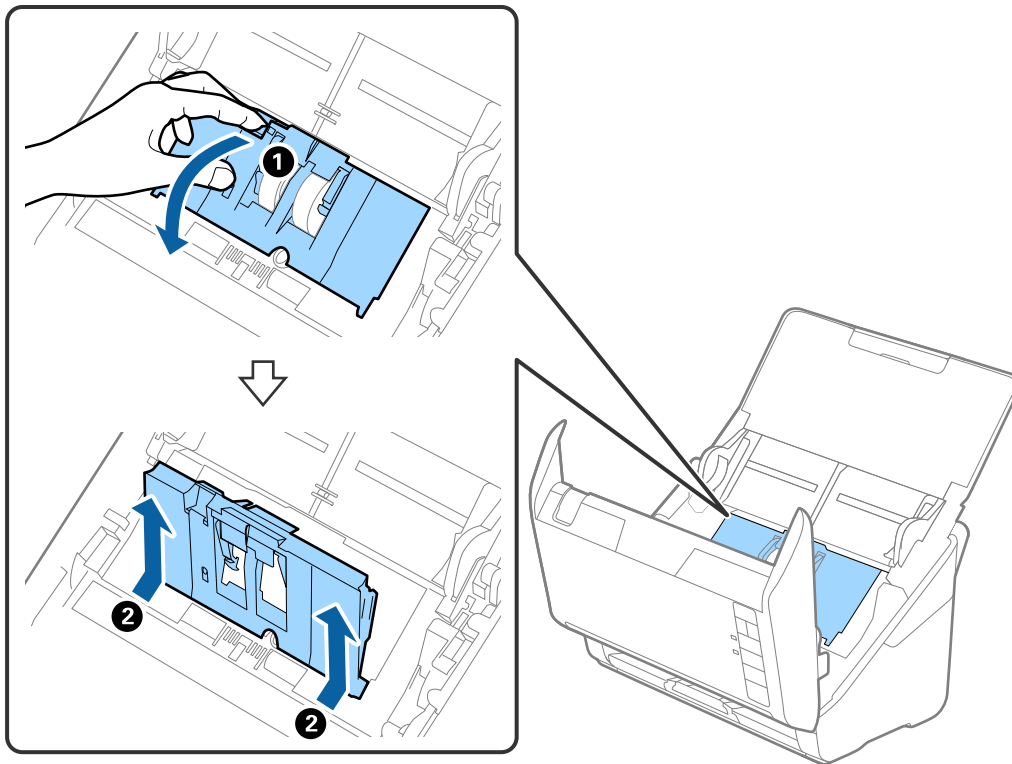

5. Pull down the fixture of the roller axis, and then slide and remove the installed pickup rollers.

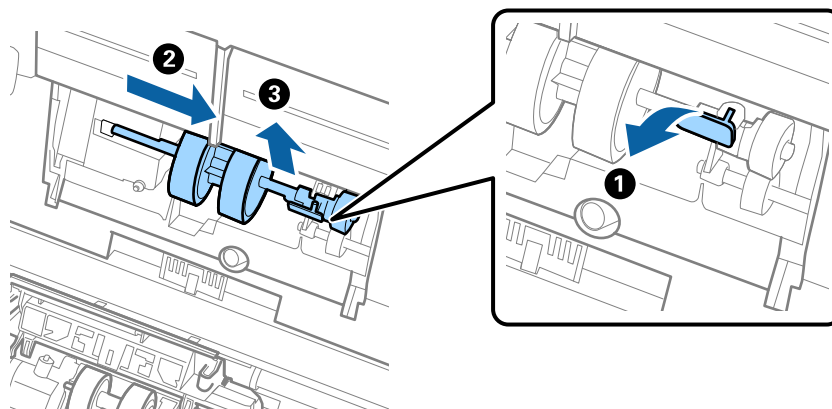

Important:

Do not pull out the pickup roller forcibly. This could damage the inside of the scanner.

Maintenance

6. While holding down the fixture, slide the new pickup roller to the left and insert it into the hole in the body. Press the fixture to secure it.

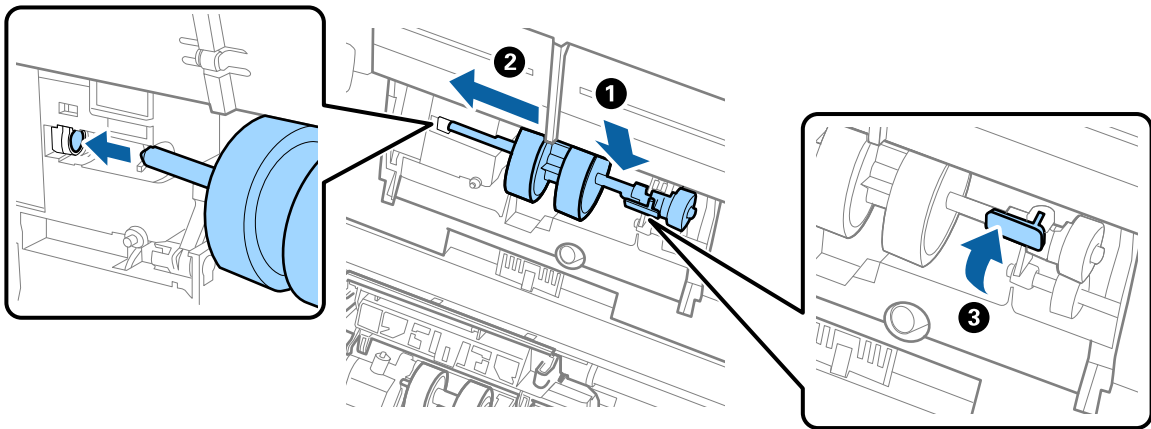

7. Put the edge of the cover of the pickup roller into the groove and slide it. Close the cover firmly.

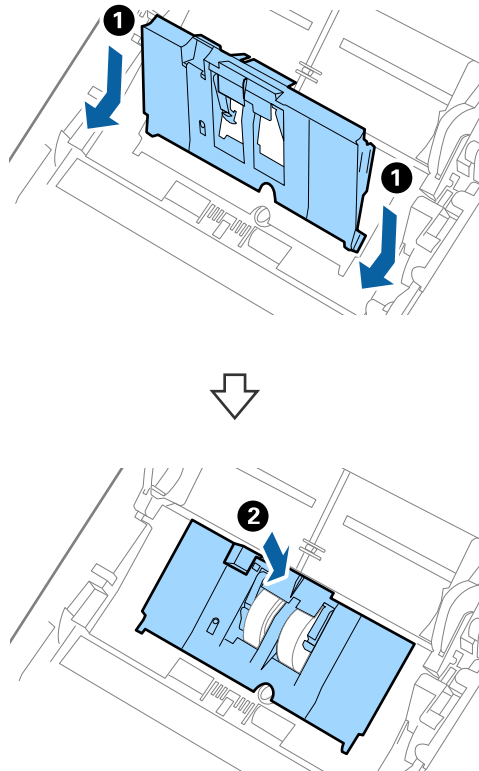

Maintenance

! *Important:*

- Make sure the pick up cover is closed correctly.*
- Make sure the pickup rollers are installed correctly if the cover is hard to close.*
- Do not install the cover while it is raised.*

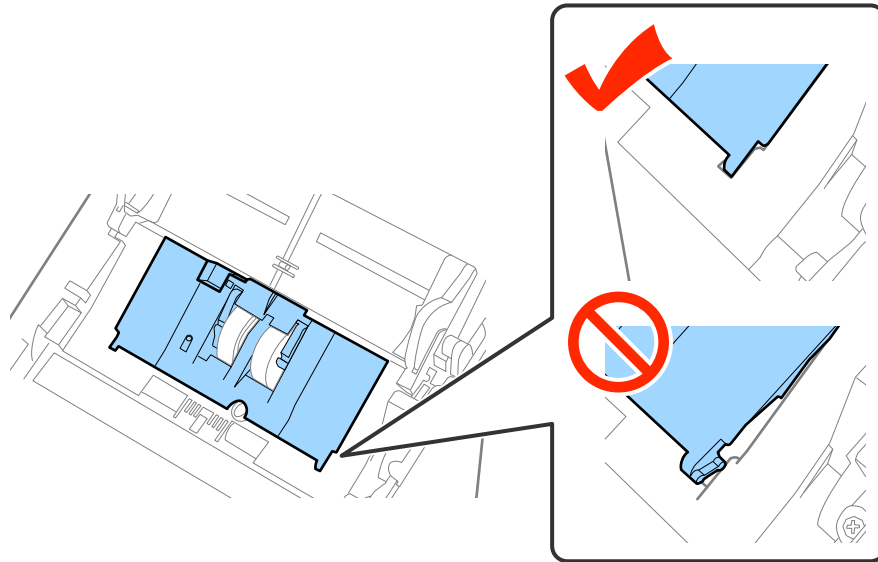

8. Push the hooks on both ends of the separation roller cover to open the cover.

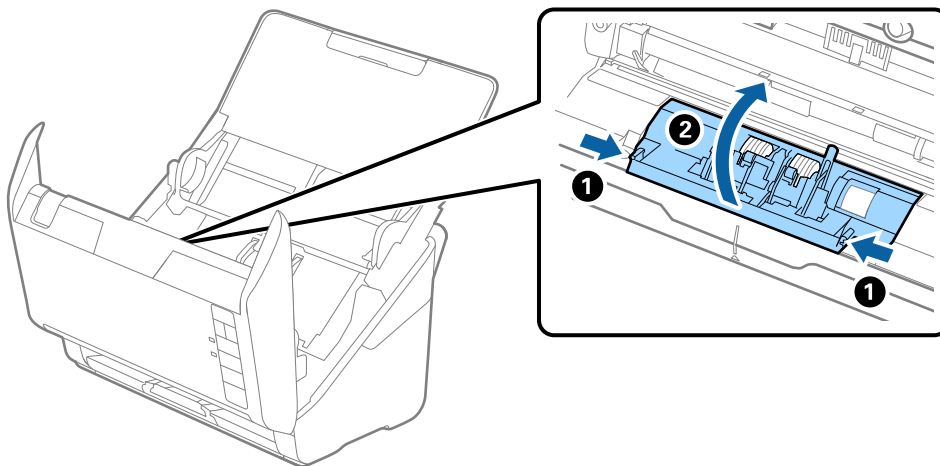

Maintenance

- Lift the left side of the separation roller, and then slide and remove the installed separation rollers.

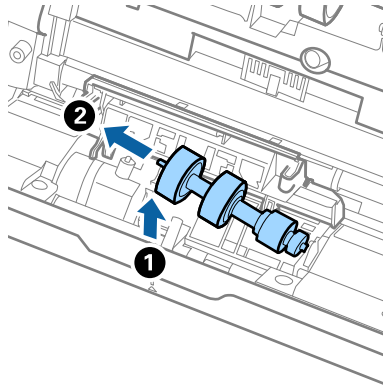

- Insert the new separation roller axis into the hole on the right side, and then lower the roller.

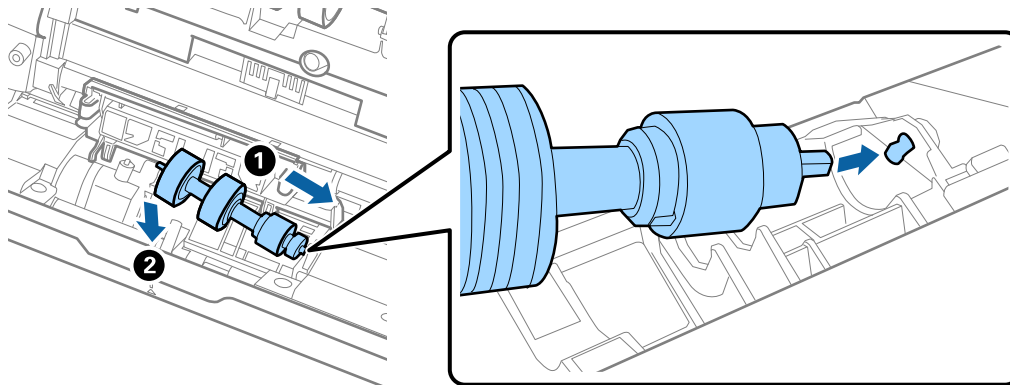

- Close the separation roller cover.



Important:

Make sure the separation rollers are installed correctly if the cover is hard to close.

- Close the scanner cover.
- Plug in the AC adapter, and then turn on the scanner.
- Reset the scan number using Epson Scan 2 Utility.

Note:

Dispose of the pickup roller and the separation roller following the rules and regulations of your local authority. Do not disassemble them.

Related Information

➔ [“Roller Assembly Kit Codes” on page 19](#)

Resetting the Number of Scans

Reset the number of scans using Epson Scan 2 Utility after replacing the Roller Assembly Kit.

Maintenance

1. Turn on the scanner.
2. Start Epson Scan 2 Utility.
 - ❑ Windows 10
Click the start button, and then select **All apps > EPSON > Epson Scan 2 > Epson Scan 2 Utility**.
 - ❑ Windows 8.1/Windows 8/Windows Server 2012 R2/Windows Server 2012
Start screen > Apps > Epson > Epson Scan 2 Utility.
 - ❑ Windows 7/Windows Vista/Windows XP/Windows Server 2008 R2/Windows Server 2008/Windows Server 2003 R2/Windows Server 2003
Click the start button, and then select **All Programs (or Programs) > EPSON > Epson Scan 2 > Epson Scan 2 Utility**.
 - ❑ Mac OS X
Select **Go > Applications > EPSON Software > Epson Scan 2 Utility**.
3. Click the **Counter** tab.
4. Click **Reset** for the roller assembly kit.

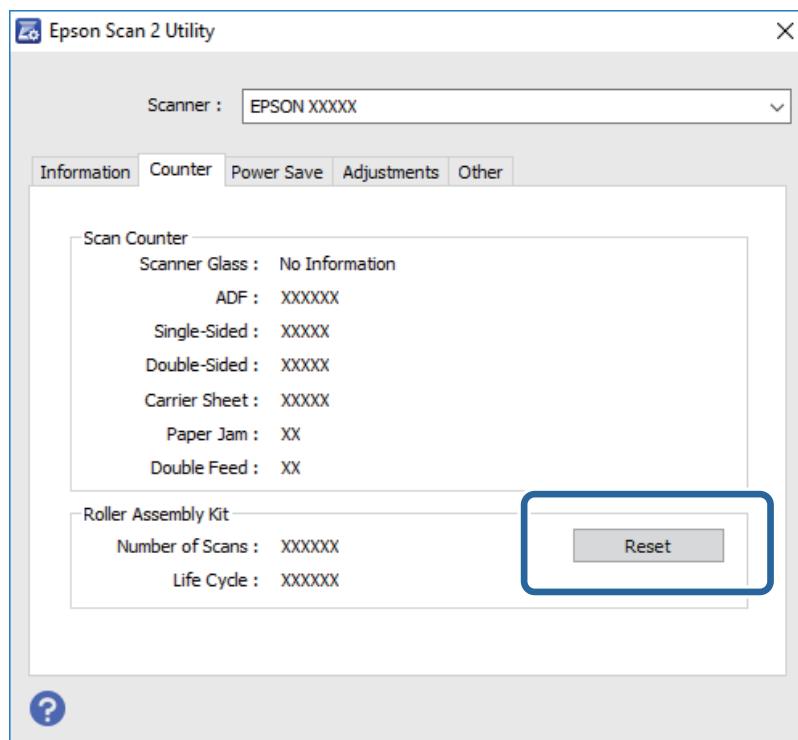

Related Information

- ➔ [“Replacing the Roller Assembly Kit” on page 96](#)

Energy Saving

You can save energy by using the sleep mode or auto power off mode when no operations are performed by the scanner. You can set the time period before the scanner enters sleep mode and turns off automatically. Any increase will affect the product's energy efficiency. Consider the environment before making any changes.

Maintenance

1. Start Epson Scan 2 Utility.
 - ❑ Windows 10
Click the start button, and then select **All apps > EPSON > Epson Scan 2 > Epson Scan 2 Utility**.
 - ❑ Windows 8.1/Windows 8/Windows Server 2012 R2/Windows Server 2012
Start screen > Apps > Epson > Epson Scan 2 Utility.
 - ❑ Windows 7/Windows Vista/Windows XP/Windows Server 2008 R2/Windows Server 2008/Windows Server 2003 R2/Windows Server 2003
Click the start button, and then select **All Programs (or Programs) > EPSON > Epson Scan 2 > Epson Scan 2 Utility**.
 - ❑ Mac OS X
Select **Go > Applications > EPSON Software > Epson Scan 2 Utility**.
2. Click the **Power Save** tab.
3. Set the **Sleep Timer (minutes)** or **Power Off Timer (minutes)**, and then click **Set**.

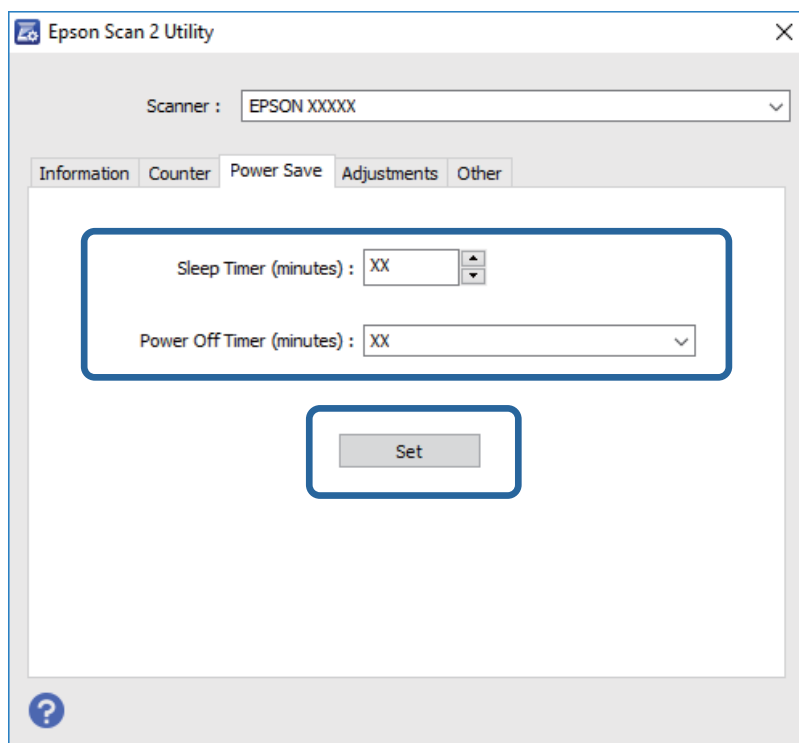

Transporting the Scanner

When you need to transport the scanner to move or for repairs, follow the steps below to pack the scanner.

1. Press the  button to turn off the scanner.
2. Unplug the AC adapter from the scanner.
3. Remove the USB cable.

Maintenance

4. Close the input tray and output tray.

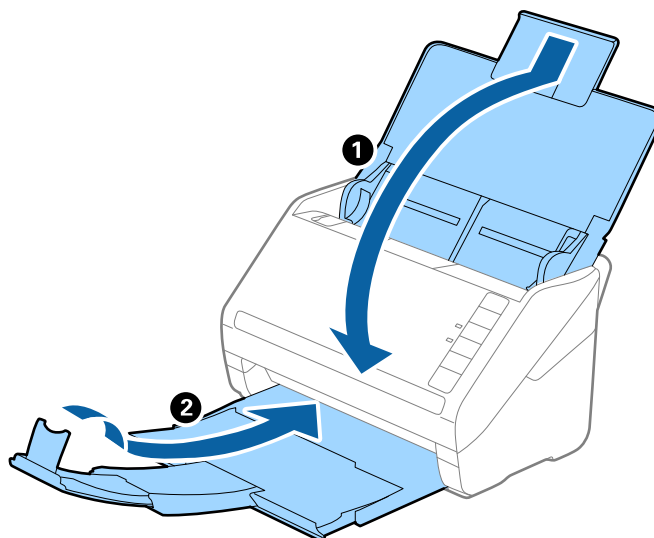
**Important:**

Make sure you close the output tray securely; otherwise it may be damaged during transport.

5. Attach the packing materials that came with the scanner, and then repack the scanner in its original box or a sturdy box.

Updating Applications and Firmware

You may be able to clear certain problems and improve or add functions by updating the applications and the firmware. Make sure you use the latest version of the applications and firmware.

1. Make sure that the scanner and the computer are connected, and the computer is connected to the internet.
2. Start EPSON Software Updater, and update the applications or the firmware.

Note:

Windows Server operating systems are not supported.

 Windows 10

Click the start button, and select **All apps > Epson Software > EPSON Software Updater**.

 Windows 8.1/Windows 8

Enter the application name in the search charm, and then select the displayed icon.

 Windows 7/Windows Vista/Windows XP

Click the start button, and then select **All Programs or Programs > Epson Software > EPSON Software Updater**.

 Mac OS X

Select **Finder > Go > Applications > Epson Software > EPSON Software Updater**.

Maintenance



Important:

Do not turn off the computer or the scanner while updating.

Note:

If you cannot find the application you want to update in the list, you cannot update using the EPSON Software Updater. Check for the latest versions of the applications on your local Epson website.

<http://www.epson.com>

Solving Problems

Scanner Problems

Scanner Lights Indicate an Error

Check the following if the scanner lights indicate an error.

- Make sure there are no originals jammed in the scanner.
- When feeding multiple originals, open the ADF cover and remove the originals. Next, close the ADF cover.
- Make sure the scanner cover is closed.
- Make sure the scanner is connected to your computer properly.
 - If a Wi-Fi connection error has occurred, check the Wi-Fi connection settings.
- Make sure Epson Scan 2 is installed correctly.
- If the firmware update fails and the scanner enters recovery mode, update the firmware again using a USB connection.
- Turn off the scanner and turn it on again. If this does not solve the problem, the scanner may be malfunctioning, or the light source in the scanner unit may need to be replaced. Contact your dealer.

Related Information

- ➔ [“Error Indicators” on page 15](#)
- ➔ [“The Original Jams in the Scanner Frequently” on page 108](#)

The Scanner Does Not Turn On

- Make sure the AC adapter is securely connected to the scanner and an electrical outlet.
- Check that the electrical outlet is working. Plug another device into the electrical outlet and check that you can turn the power on.

Problems Starting Scanning

Cannot Start Epson Scan 2

- Make sure the scanner is connected to your computer properly.
 - If a Wi-Fi connection error has occurred, check the Wi-Fi connection settings.
- Make sure the USB cable is securely connected to the scanner and the computer.
- Use the USB cable that came with the scanner.
- If you are using the scanner with the Network Interface Unit, make sure the network cable is securely connected.

Solving Problems

- Make sure the scanner is turned on.
- Wait until the status light stops flashing indicating that the scanner is ready to scan.
- Connect the scanner directly to the computer's USB port. The scanner may not work properly when connected to the computer through one or more USB hubs.
- If you are using any TWAIN-compliant applications, make sure that the correct scanner is selected as the scanner or source setting.

Pressing a Scanner Button Does Not Start the Correct Application

- Make sure the scanner is connected to your computer properly.
- Make sure Epson Scan 2 and other applications are installed correctly.
- Make sure Document Capture Pro (Windows) or Document Capture (Mac OS X) is installed correctly.
- Check the correct setting is assigned to the scanner button in Document Capture Pro (Windows) or Document Capture (Mac OS X).
- When using a wireless connection, you cannot run the job assigned to a scanner button by pressing it because Document Capture Pro and Document Capture do not support scanning from the button over a wireless connection.

To start scanning by pressing the button, launch Epson Scan 2 on your computer before scanning.

Related Information

- ➔ [“Scanning Using a Scanner Button” on page 62](#)

Paper Feeding Problems

Multiple Originals Are Fed

If multiple originals are fed, open the scanner cover and remove the originals. Next, close the scanner cover.

If multiple originals are fed frequently, try the following.

- If you load unsupported originals, the scanner may feed multiple originals at a time.
- Clean the rollers inside the scanner.
- Reduce the number of originals being placed at a time.
- Press the  button to slow down the scanning speed.
- Use **Automatic Feeding Mode** in Epson Scan 2, and scan originals one by one.

Related Information

- ➔ [“Cleaning Inside the Scanner” on page 91](#)
- ➔ [“Scanning Different Sizes or Types of Originals One by One \(Automatic Feeding Mode\)” on page 64](#)

Solving Problems

Removing Jammed Originals from the Scanner

If an original has jammed inside the scanner, follow these steps to remove it.

1. Remove all originals remaining in the input tray.
2. Pull the cover open lever and open the scanner cover.

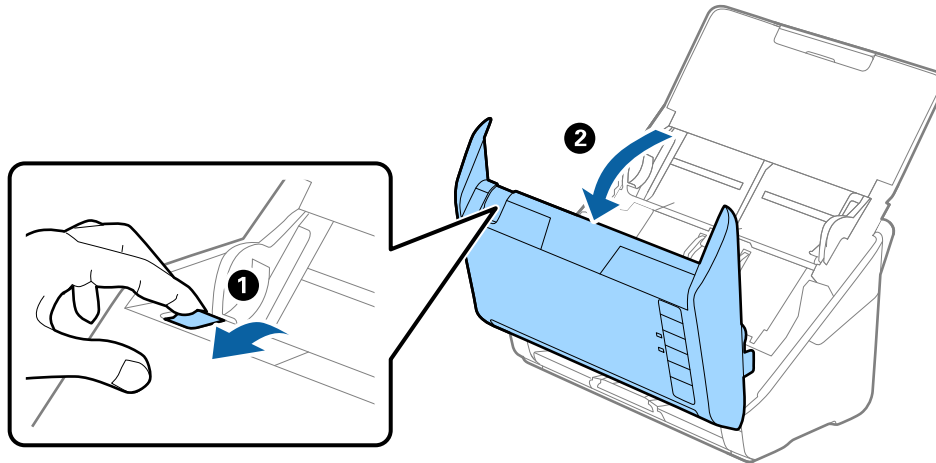

3. Carefully remove any originals remaining inside the scanner.

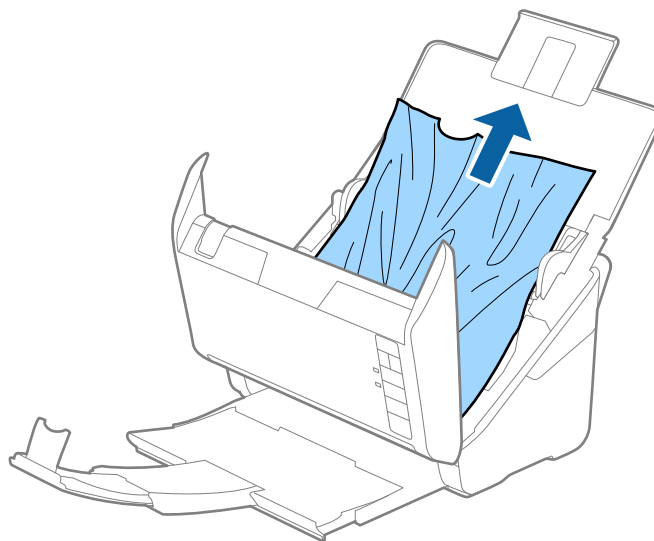

Solving Problems

- Carefully pull out any jammed originals from the output tray in the direction of the arrow if you cannot pull originals straight up.

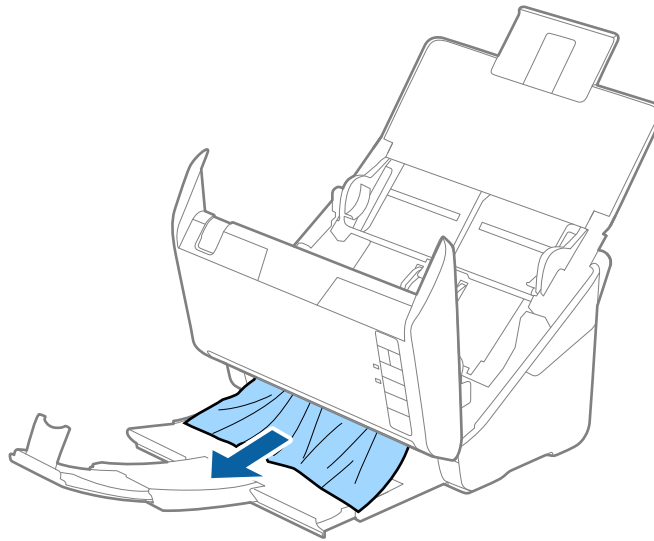

Important:

Make sure there is no paper inside the scanner.

- Close the scanner cover.

The Original Jams in the Scanner Frequently

If the original jams in the scanner frequently, try the following.

- Press the  button to slow down the scanning speed.
- Clean the rollers inside the scanner.
- If the ejected originals get stuck in the output tray, store the output tray and do not use it.

Related Information

➔ [“Cleaning Inside the Scanner” on page 91](#)

The Originals Get Dirty

Clean the inside of the scanner.

Related Information

➔ [“Cleaning Inside the Scanner” on page 91](#)

Scanning Speed Slows Down when Scanning Continuously

When scanning continuously using the ADF, scanning slows down to prevent the scanner mechanism from overheating and being damaged. However, you can continue scanning.

To regain normal scanning speed, leave the scanner idle for at least 30 minutes. Scanning speed does not recover even if the power is off.

Scanning Takes a Long Time

- When the resolution is high, scanning may take some time.
- Computers with USB 3.0 (SuperSpeed) or USB 2.0 (Hi-Speed) ports can scan faster than those with USB 1.1 ports. If you are using a USB 3.0 or USB 2.0 port with the scanner, make sure it meets the system requirements.
- When using security software, exclude the TWAIN.log file from monitoring, or set the TWAIN.log as a read-only file. For more information on your security software's functions, see the help and so on supplied with the software. The TWAIN.log file is saved in the following locations.
 - Windows 10/Windows 8.1/ Windows 8/ Windows 7/ Windows Vista:
C:\Users*(user name)*\AppData\Local\Temp
 - Windows XP:
C:\Documents and Settings*(user name)*\Local Settings\Temp

Scanned Image Problems

Straight Lines Appear when Scanning from ADF

- Clean the ADF.
Straight lines may appear in the image when trash or dirt gets into the ADF.
- Remove any trash or dirt that adheres to the original.

Related Information

➔ [“Cleaning Inside the Scanner” on page 91](#)

The Image Quality is Rough

- If the resolution is low, try increasing the resolution and then scanning.
- In Epson Scan 2, adjust the image using items on the **Advanced Settings** tab, and then scan.

Related Information

➔ [“Setting a Resolution That Suits the Scanning Purpose” on page 57](#)
➔ [“Image Adjustment Features” on page 65](#)

Solving Problems

Expanding or Contracting the Scanned Image

When expanding or contracting the scanned image, you can adjust the expansion ratio by using the **Adjustments** feature in Epson Scan 2 Utility. This feature is only available for Windows.

Note:

Epson Scan 2 Utility is an application that comes with Epson Scan 2.

1. Start Epson Scan 2 Utility.
 - Windows 10
Click the start button, and then select **All apps > EPSON > Epson Scan 2 > Epson Scan 2 Utility**.
 - Windows 8.1/Windows 8/Windows Server 2012 R2/Windows Server 2012
Enter the application name in the search charm, and then select the displayed icon.
 - Windows 7/Windows Vista/Windows XP/Windows Server 2008 R2/Windows Server 2008/Windows Server 2003 R2/Windows Server 2003
Click the start button, and then select **All Programs or Programs > EPSON > Epson Scan 2 > Epson Scan 2 Utility**.
2. Select the **Adjustments** tab.
3. Use **Expansion/Contraction** to adjust the expansion ratio for scanned images.
4. Click **Set** to apply the settings to the scanner.

Offset Appears in the Background of Images

Images on the back of the original may appear in the scanned image.

- In Epson Scan 2, select the **Advanced Settings** tab, and then adjust the **Brightness**.
This feature may not be available depending on the settings on the **Main Settings** tab > **Image Type** or other settings on the **Advanced Settings** tab.
- In Epson Scan 2, select the **Advanced Settings** tab, and then **Image Option > Text Enhancement**.

Related Information

➔ [“Brightness” on page 69](#)

You can adjust the brightness for the whole image.

➔ [“Text Enhancement” on page 68](#)

You can make blurred letters in the original clear and sharp. You can also reduce the offset or unevenness of the background.

Text is Blurred

- In Epson Scan 2, select the **Advanced Settings** tab, and then **Image Option > Text Enhancement**.
- In Epson Scan 2, when **Image Type** on the **Main Settings** tab is set to **Black & White**, adjust the **Threshold** on the **Advanced Settings** tab. When you increase the **Threshold**, black becomes stronger.
- If the resolution is low, try increasing the resolution and then scanning.

Solving Problems

Related Information

➔ [“Text Enhancement” on page 68](#)

You can make blurred letters in the original clear and sharp. You can also reduce the offset or unevenness of the background.

➔ [“Threshold” on page 70](#)

You can adjust the border for monochrome binary (black and white). Increase the threshold, the black color area becomes larger. Decrease the threshold, the white color area becomes larger.

➔ [“Setting a Resolution That Suits the Scanning Purpose” on page 57](#)

Moiré Patterns (Web-Like Shadows) Appear

If the original is a printed document, moiré patterns (web-like shadows) may appear in the scanned image.

- On the **Advanced Settings** tab in Epson Scan 2, select **Descreening**.



- Change the resolution, and then scan again.

Related Information

➔ [“Descreening” on page 67](#)

You can remove moiré patterns (web-like shadows) that appear when scanning printed paper such as a magazine.

➔ [“Setting a Resolution That Suits the Scanning Purpose” on page 57](#)

The Edge of the Original is Not Scanned when Automatically Detecting the Size of the Original

- In Epson Scan 2, select the **Main Settings** tab, and then select **Document Size > Settings**. On the **Document Size Settings** window, adjust **Crop Margins for Size "Auto"**.
- Depending on the original, the area of the original may not be detected correctly when using the **Auto Detect** feature. Select the appropriate size of the original from the **Document Size** list.

Note:

*If the size of the original you want to scan is not on the list, select **Customize**, and then create the size manually.*

Text is Not Recognized Correctly when Saving as a Searchable PDF

- On the **Image Format Options** window in Epson Scan 2, check that **Text Language** is set correctly on the **Text** tab.
- Check that the original is placed straight.

Solving Problems

- ❑ Use an original with clear text. Text recognition may decline for the following types of originals.
 - ❑ Originals that have been copied a number of times
 - ❑ Originals received by fax (at low resolutions)
 - ❑ Originals on which the letter spacing or line spacing is too small
 - ❑ Originals with ruled lines or underlining over the text
 - ❑ Originals with hand-written text
 - ❑ Originals with creases or wrinkles
- ❑ In Epson Scan 2, when **Image Type** on the **Main Settings** tab is set to **Black & White**, adjust the **Threshold** on the **Advanced Settings** tab. When you increase the **Threshold**, the black color area becomes larger.
- ❑ In Epson Scan 2, select the **Advanced Settings** tab, and then **Image Option > Text Enhancement**.

Related Information

➔ [“Saving as a Searchable PDF” on page 72](#)

➔ [“Text Enhancement” on page 68](#)

You can make blurred letters in the original clear and sharp. You can also reduce the offset or unevenness of the background.

➔ [“Threshold” on page 70](#)

You can adjust the border for monochrome binary (black and white). Increase the threshold, the black color area becomes larger. Decrease the threshold, the white color area becomes larger.

Cannot Solve Problems in the Scanned Image

If you have tried all of the solutions and have not solved the problem, initialize the Epson Scan 2 settings using Epson Scan 2 Utility.

Note:

Epson Scan 2 Utility is an application that comes with Epson Scan 2.

1. Start Epson Scan 2 Utility.

❑ Windows 10

Click the start button, and then select **All apps > EPSON > Epson Scan 2 Utility**.

❑ Windows 8.1/Windows 8/Windows Server 2012 R2/Windows Server 2012

Enter the application name in the search charm, and then select the displayed icon.

❑ Windows 7/Windows Vista/Windows XP/Windows Server 2008 R2/Windows Server 2008/Windows Server 2003 R2/Windows Server 2003

Click the start button, and then select **All Programs** or **Programs > EPSON > Epson Scan 2 > Epson Scan 2 Utility**.

❑ Mac OS X

Select **Go > Applications > Epson Software > Epson Scan 2 Utility**.

2. Select the **Other** tab.

3. Click **Reset**.

Note:

If initialization does not solve the problem, uninstall and re-install Epson Scan 2.

Network Problems

When You Cannot Make Network Settings

Turn off the devices you want to connect to the network. Wait for about 10 seconds, and then turn on the devices in the following order; access point, computer or smart device, and then scanner. Move the scanner and computer or smart device closer to the access point to help with radio wave communication, and then try to make network settings again.

Cannot Connect from Devices Even Though Network Settings are No Problems

If you cannot connect from the computer or smart device to the scanner even though network settings of the scanner are no problem, see the following.

- ❑ When you are using multiple access points at the same time, you may not be able to use the scanner from the computer or smart device depending on the settings of the access points. Connect the computer or smart device to the same access point as the scanner.

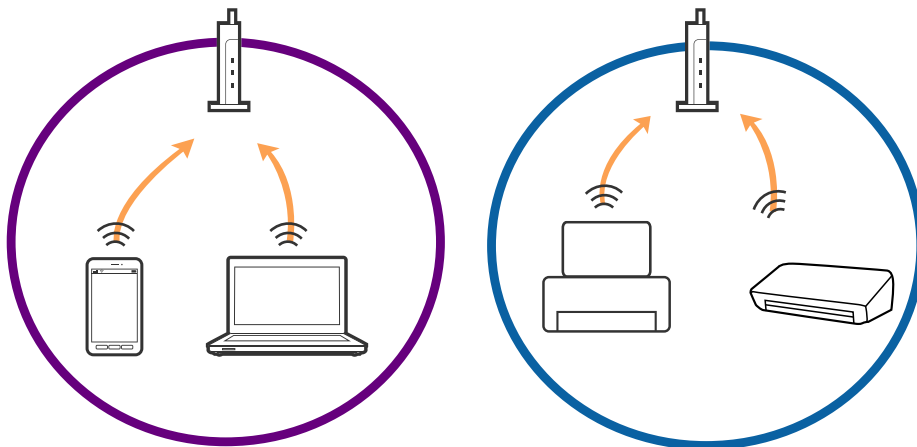

- ❑ You may not be able to connect to the access point when the access point has multiple SSIDs and devices are connected to different SSIDs on the same access point. Connect the computer or smart device to the same SSID as the scanner.

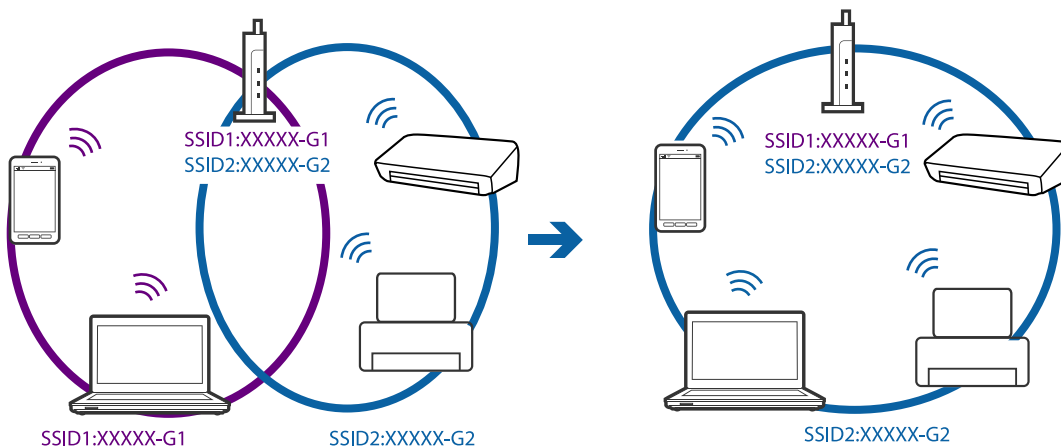

Solving Problems

- ❑ An access point that is compliant with both IEEE802.11a and IEEE802.11g has SSIDs of 2.4 GHz and 5 GHz. If you connect the computer or smart device to a 5 GHz SSID, you cannot connect to the scanner because the scanner only supports communication over 2.4 GHz. Connect the computer or smart device to the same SSID as the scanner.

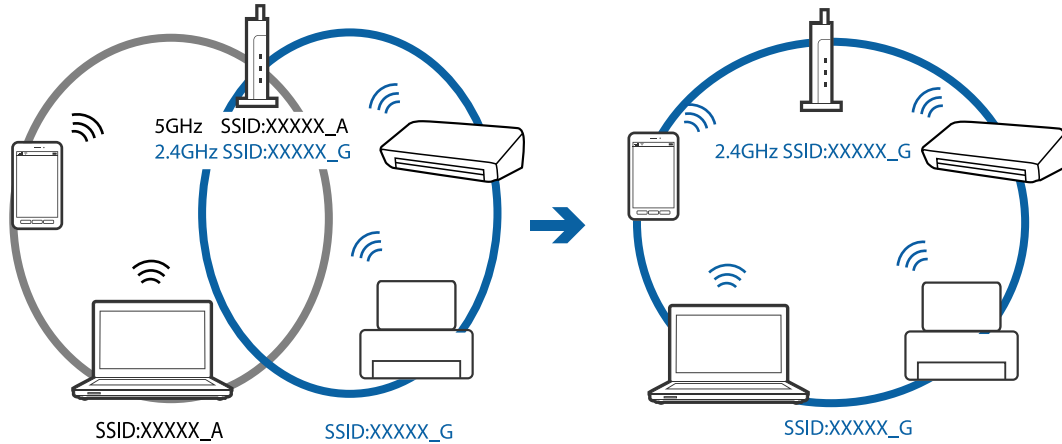

- ❑ Most access points have a privacy separator feature that blocks communication between connected devices. If you cannot communicate between the scanner and the computer or smart device even if they are connected to the same network, disable the privacy separator on the access point. See the manual provided with the access point for details.

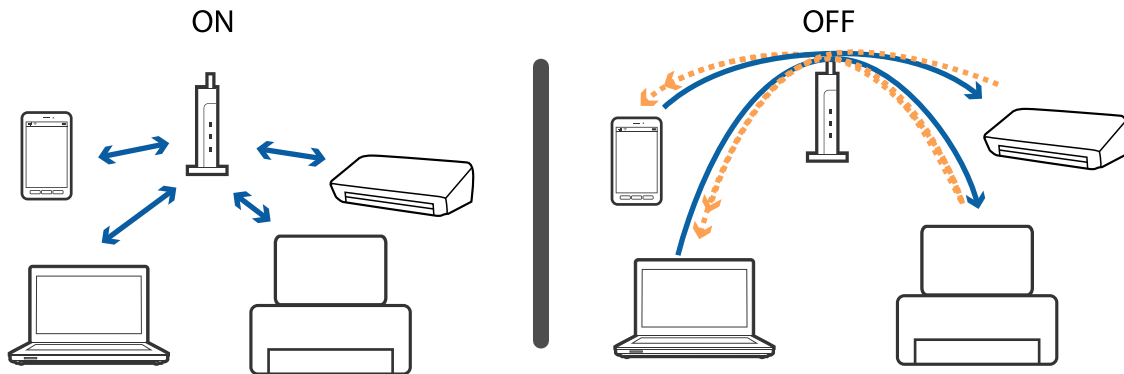

Related Information

- ➔ [“Checking the SSID Connected to the Scanner” on page 114](#)
- ➔ [“Checking the SSID for the Computer” on page 115](#)

Checking the SSID Connected to the Scanner

You can check the connected SSID on Web Config.

And you can check the SSID and password of scanner itself on the label stuck to the scanner. These are used when you connect the scanner in AP mode connection.

Related Information

- ➔ [“Web Config” on page 17](#)

Checking the SSID for the Computer

Windows

Select **Control Panel > Network and Internet > Network and Sharing Center**.

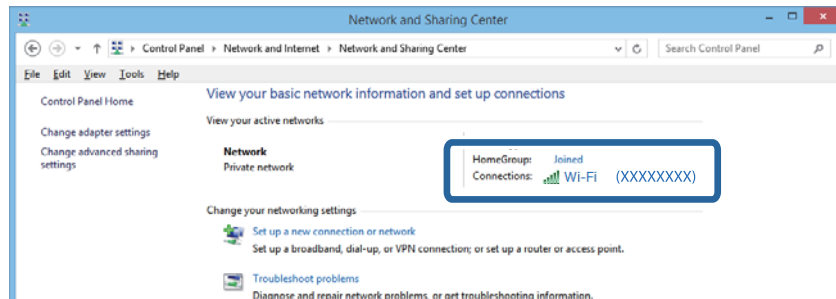

Mac OS X

Click the Wi-Fi icon at the top of the computer screen. A list of SSIDs is displayed and the connected SSID is indicated with a check mark.



The Scanner Suddenly Cannot Scan over a Network Connection

- When you have changed your access point or provider, try making network settings for the scanner again. Connect the computer or smart device to the same SSID as the scanner.
- Turn off the devices you want to connect to the network. Wait for about 10 seconds, and then turn on the devices in the following order; access point, computer or smart device, and then scanner. Move the scanner and computer or smart device closer to the access point to help with radio wave communication, and then try to make network settings again.
- Try accessing any website from your computer to make sure that your computer's network settings are correct. If you cannot access any websites, there is a problem on the computer. See the manual provided with your computer for more details.
- Check if the network setting is correct on Epson Scan 2 Utility.

Solving Problems

- ❑ When scanning from the scanner button, make sure you start Epson Scan 2 on your computer before pressing the scanner button.

Related Information

- ➔ [“Checking the SSID Connected to the Scanner” on page 114](#)
- ➔ [“Checking the SSID for the Computer” on page 115](#)
- ➔ [“Cannot Connect from Devices Even Though Network Settings are No Problems” on page 113](#)

The Scanner Suddenly Cannot Scan Using a USB Connection

- ❑ Disconnect the USB cable from the computer. Right-click on the scanner icon displayed on the computer, and then select **Remove Device**. Connect the USB cable to the computer and try a test scan. If scanning is possible, the setup is complete.
- ❑ Re-set the USB connection following the steps in [Changing the Connection Method to a Computer] in this manual.
- ❑ If a computer is connected to the scanner by USB while another computer is also connected to the scanner over a wireless connection and Epson Scan 2 is running on this computer, scanned images are saved to the wirelessly connected scanner when you press the scanner button. Scan from the computer instead of using the scanner button or close Epson Scan 2 on the wirelessly connected computer.

Related Information

- ➔ [“Changing the Connection Method to a Computer” on page 88](#)

Uninstalling and Installing Applications

Uninstalling Your Applications

You may need to uninstall and then reinstall your applications to solve certain problems or if you upgrade your operating system. Log on to your computer as an administrator. Enter the administrator password if the computer prompts you.

Uninstalling Your Applications for Windows

1. Quit all running applications.
2. Disconnect the scanner from your computer.
3. Open the Control Panel:
 - ❑ Windows 10
Right-click the start button or press and hold it, and then select **Control Panel**.

Solving Problems

- Windows 8.1/Windows 8/Windows Server 2012 R2/Windows Server 2012

Select **Desktop > Settings > Control Panel**.

- Windows 7/Windows Vista/Windows XP/Windows Server 2008 R2/Windows Server 2008/Windows Server 2003 R2/Windows Server 2003

Click the start button and select **Control Panel**.

4. Open **Uninstall a program** (or **Add or Remove Programs**):

- Windows 10/Windows 8.1/Windows 8/Windows 7/Windows Vista/Windows Server 2012 R2/Windows Server 2012/Windows Server 2008 R2/Windows Server 2008

Select **Uninstall a program** in **Programs**.

- Windows XP/Windows Server 2003 R2/Windows Server 2003

Click **Add or Remove Programs**.

5. Select the application you want to uninstall.

6. Uninstall the applications:

- Windows 10/Windows 8.1/Windows 8/Windows 7/Windows Vista/Windows Server 2012 R2/Windows Server 2012/Windows Server 2008 R2/Windows Server 2008

Click **Uninstall/Change** or **Uninstall**.

- Windows XP/Windows Server 2003 R2/Windows Server 2003

Click **Change/Remove** or **Remove**.

Note:

If the User Account Control window is displayed, click Continue.

7. Follow the on-screen instructions.

Note:

*A message may be displayed prompting you to restart your computer. If it is displayed, make sure **I want to restart my computer now** is selected, and then click **Finish**.*

Uninstalling Your Applications for Mac OS X

Note:

Make sure you installed EPSON Software Updater.

1. Download the Uninstaller using EPSON Software Updater.

Once you have downloaded the Uninstaller, you do not need to download it again each time you uninstall the application.

2. Disconnect the scanner from your computer.

3. To uninstall the scanner driver, select **System Preferences** from the  menu > **Printers & Scanners** (or **Print & Scan, Print & Fax**), and then remove the scanner from the enabled scanner list.

4. Quit all running applications.

5. Select **Finder > Go > Applications > Epson Software > Uninstaller**.

Solving Problems

6. Select the application you want to uninstall, and then click Uninstall.

 **Important:**

The Uninstaller removes all drivers for Epson scanners on the computer. If you use multiple Epson scanners and you only want to delete some of the drivers, delete all of them first, and then install the necessary scanner drivers again.

Note:

*If you cannot find the application you want to uninstall in the application list, you cannot uninstall using the Uninstaller. In this situation, select **Finder > Go > Applications > Epson Software**, select the application you want to uninstall, and then drag it to the trash icon.*

Installing Your Applications

Follow the steps below to install the necessary applications.

Note:

- Log on to your computer as an administrator. Enter the administrator password if the computer prompts you.
- When reinstalling applications, you need to uninstall them first.

1. Quit all running applications.
2. When installing Epson Scan 2, disconnect the scanner and the computer temporarily.

Note:

Do not connect the scanner and the computer until you are instructed to do so.

3. Install the application by following the instructions on the Website below.

<http://epson.sn>

Note:

For Windows, you can also use the software disc that came with the scanner.

Technical Specifications

General Scanner Specifications

Note:

Specifications are subject to change without notice.

Scanner type	Sheet Feed, one pass duplex color scanner
Photoelectric device	CIS
Effective pixels	5,100×9,300 at 600 dpi 2,500×64,500 at 300 dpi
Light source	RGB LED
Scanning resolution	600 dpi (main scan) 600 dpi (sub scan)
Output resolution	75 to 1200 dpi (in 1 dpi increments) *1
Document Size	Max: 215.9×6,096 mm (8.5×240 inches) Min: 50.8×50.8 mm (2×2 inches)
Paper input	Face-down loading
Paper output	Face-down ejection
Paper capacity	50 sheets of paper at 80 g/m ²
Color Depth	Color <input type="checkbox"/> 30 bits per pixel internal (10 bits per pixel per color internal) <input type="checkbox"/> 24 bits per pixel external (8 bits per pixel per color external) Grayscale <input type="checkbox"/> 10 bits per pixel internal <input type="checkbox"/> 8 bits per pixel external Black and white <input type="checkbox"/> 10 bits per pixel internal <input type="checkbox"/> 1 bit per pixel external
Interface*2	SuperSpeed USB IEEE802.11b/g/n Ethernet 1000BASE-T/100BASE-TX/10BASE-T (optional) NFC Simple Tag (No interface with the scanner controller)

*1 75 to 300 dpi (393.7 to 5,461.0 mm (15.5 to 215 in.) in length), 75 to 200 dpi (5,461.1 to 6,096.0 mm (215 to 240 in.) in length)

*2 You cannot use a USB and network connection at the same time.

Technical Specifications

Wi-Fi Specifications

Standards	IEEE802.11b/g/n
Frequency Range	2.4 GHz
Maximum radio-frequency power transmitted	19.8 dBm (EIRP)
Coordination Modes	Infrastructure mode, Ad hoc mode ^{*1} , AP mode ^{*2 *3}
Wireless Security	WEP (64/128bit), WPA2-PSK (AES) ^{*4} , WPA2-Enterprise ^{*5}

*1 Not supported for IEEE 802.11n.

*2 Not supported for IEEE 802.11b.

*3 AP mode connection and Wi-Fi connection can be used at the same time.

*4 Complies with WPA2 standards with support for WPA/WPA2 Personal.

*5 Complies with WPA2 standards with support for WPA/WPA2 Enterprise.

Security Protocol

SSL/TLS	HTTPS (Server/Client), SMTPS (Client), STARTTLS, Root certificate (Client), Root certificate updating (Client), CA-signed certificate (Server), CA certificate (Server), CSR generation (Server), Self-signed certificate (Server), EC key CSR/self-signed certificate generation (Server), Certificates/Secret key imports (Server)
Authentication for Email sending	POP before SMTP, APOP, SMTP Authentication
MIB accessing Authentication/Encryption	SNMPv3

Dimensional Specifications

Dimensions *	Width: 296 mm (11.7 inches) Depth: 169 mm (6.7 inches) Height: 176 mm (6.9 inches)
Weight	Approx. 3.7 kg (8.2 lb)

* Without protruding parts.

Electrical Specifications

Scanner Electrical Specifications

Rated DC Input Power Supply Voltage	DC 24 V
Rated DC Input Current	2 A
Power Consumption	<p>USB Connection</p> <ul style="list-style-type: none"> <input type="checkbox"/> Operating: Approx. 17 W <input type="checkbox"/> Ready mode: Approx. 9.2 W <input type="checkbox"/> Sleep mode : Approx. 1.2 W <input type="checkbox"/> Power off: Approx. 0.1 W <p>Wi-Fi Connection</p> <ul style="list-style-type: none"> <input type="checkbox"/> Operating: Approx. 18 W <input type="checkbox"/> Ready mode: Approx. 9.2 W <input type="checkbox"/> Sleep mode : Approx. 1.4 W <input type="checkbox"/> Power off: Approx. 0.1 W

AC Adapter Electrical Specifications

Model	A471H (AC 100 to 240 V) A472E (AC 220 to 240 V)
Rated Input Current	1.2 A
Rated Frequency Range	50 to 60 Hz
Rated Output Power Supply Voltage	DC 24 V
Rated Output Current	2 A

Environmental Specifications

Temperature	When operating	5 to 35 °C (41 to 95 °F)
	When stored	-25 to 60 °C (-13 to 140 °F)
Humidity	When operating	15 to 80% (without condensation)
	When stored	15 to 85% (without condensation)
Operating conditions		Ordinary office or home conditions. Avoid operating the scanner in direct sunlight, near a strong light source, or in extremely dusty conditions.

System Requirements

Windows	<p>Windows 10 (32-bit, 64-bit)</p> <p>Windows 8.1 (32-bit, 64-bit)</p> <p>Windows 8 (32-bit, 64-bit)</p> <p>Windows 7 (32-bit, 64-bit)</p> <p>Windows Vista (32-bit, 64-bit)</p> <p>Windows XP Professional x64 Edition Service Pack 2</p> <p>Windows XP (32-bit) Service Pack 3</p> <p>Windows Server 2012 R2</p> <p>Windows Server 2012</p> <p>Windows Server 2008 R2</p> <p>Windows Server 2008 (32-bit, 64-bit)</p> <p>Windows Server 2003 R2 (32-bit, 64-bit)</p> <p>Windows Server 2003 (32-bit, 64-bit) Service Pack 2</p>
Mac OS X *1 *2	<p>Mac OS X v10.11.x</p> <p>Mac OS X v10.10.x</p> <p>Mac OS X v10.9.x</p> <p>Mac OS X v10.8.x</p> <p>Mac OS X v10.7.x</p> <p>Mac OS X v10.6.8</p>

*1 Fast User Switching on Mac OS X or later is not supported.

*2 The UNIX File System (UFS) for Mac OS X is not supported.

Standards and Approvals

Standards and Approvals for U.S. Models

Product

EMC	FCC Part 15 Subpart B Class B CAN/CSA-CEI/IEC CISPR 22 Class B
-----	---

This equipment contains the following wireless module.

Manufacturer: Askey Computer Corporation

Type: WLU6320-D69 (RoHS)

This product conforms to Part 15 of the FCC Rules and RSS-210 of the IC Rules. Epson cannot accept responsibility for any failure to satisfy the protection requirements resulting from a non-recommended modification of the product. Operation is subject to the following two conditions: (1) this device may not cause harmful interference, and (2) this device must accept any interference received, including interference that may cause undesired operation of the device.

To prevent radio interference to the licensed service, this device is intended to be operated indoors and away from windows to provide maximum shielding. Equipment (or its transmit antenna) that is installed outdoors is subject to licensing.

AC adapter (A471H)

Safety	UL60950-1 CAN/CSA-C22.2 No.60950-1
EMC	FCC Part 15 Subpart B Class B CAN/CSA-CEI/IEC CISPR 22 Class B

Standards and Approvals for European Models

Product and AC adapter

For European users

Hereby, Seiko Epson Corporation declares that the following radio equipment models are in compliance with Directive 2014/53/EU. The full text of the EU declaration of conformity is available at the following website.

<http://www.epson.eu/conformity>

J381B

A471H, A472E

For use only in Ireland, UK, Austria, Germany, Liechtenstein, Switzerland, France, Belgium, Luxembourg, Netherlands, Italy, Portugal, Spain, Denmark, Finland, Norway, Sweden, Iceland, Croatia, Cyprus, Greece, Slovenia, Malta, Bulgaria, Czech, Estonia, Hungary, Latvia, Lithuania, Poland, Romania, and Slovakia.

Standards and Approvals

Epson cannot accept responsibility for any failure to satisfy the protection requirements resulting from a non-recommended modification of the product.



Standards and Approvals for Australian Models

Product

EMC	AS/NZS CISPR22 Class B
-----	------------------------

Epson hereby declares that the following equipment Models are in compliance with the essential requirements and other relevant provisions of AS/NZS4268:

J381B

Epson cannot accept responsibility for any failure to satisfy the protection requirements resulting from a non-recommended modification of the product.

AC adapter (A471H)

Safety	AS/NZS 60950.1
EMC	AS/NZS CISPR22 Class B

Where to Get Help

Technical Support Web Site

If you need further help, visit the Epson support website shown below. Select your country or region and go to the support section of your local Epson website. The latest drivers, FAQs, manuals, or other downloadables are also available from the site.

<http://support.epson.net/>

<http://www.epson.eu/Support> (Europe)

If your Epson product is not operating properly and you cannot solve the problem, contact Epson support services for assistance.

Contacting Epson Support

Before Contacting Epson

If your Epson product is not operating properly and you cannot solve the problem using the troubleshooting information in your product manuals, contact Epson support services for assistance. If Epson support for your area is not listed below, contact the dealer where you purchased your product.

Epson support will be able to help you much more quickly if you give them the following information:

- Product serial number
(The serial number label is usually on the back of the product.)
- Product model
- Product software version
(Click **About**, **Version Info**, or a similar button in the product software.)
- Brand and model of your computer
- Your computer operating system name and version
- Names and versions of the software applications you normally use with your product

Note:

Depending on the product, the dial list data for fax and/or network settings may be stored in the product's memory. Due to breakdown or repair of a product, data and/or settings may be lost. Epson shall not be responsible for the loss of any data, for backing up or recovering data and/or settings even during a warranty period. We recommend that you make your own backup data or take notes.

Help for Users in Europe

Check your Pan-European Warranty Document for information on how to contact Epson support.

Where to Get Help

Help for Users in Taiwan

Contacts for information, support, and services are:

World Wide Web

<http://www.epson.com.tw>

Information on product specifications, drivers for download, and products enquiry are available.

Epson HelpDesk

Phone: +886-2-80242008

Our HelpDesk team can help you with the following over the phone:

- Sales enquiries and product information
- Product usage questions or problems
- Enquiries on repair service and warranty

Repair service center:

<http://www.tekcare.com.tw/branchMap.page>

TekCare corporation is an authorized service center for Epson Taiwan Technology & Trading Ltd.

Help for Users in Australia

Epson Australia wishes to provide you with a high level of customer service. In addition to your product manuals, we provide the following sources for obtaining information:

Internet URL

<http://www.epson.com.au>

Access the Epson Australia World Wide Web pages. Worth taking your modem here for the occasional surf! The site provides a download area for drivers, Epson contact points, new product information and technical support (e-mail).

Epson Helpdesk

Phone: 1300-361-054

Epson Helpdesk is provided as a final backup to make sure our clients have access to advice. Operators on the Helpdesk can aid you in installing, configuring and operating your Epson product. Our Pre-sales Helpdesk staff can provide literature on new Epson products and advise where the nearest dealer or service agent is located. Many types of queries are answered here.

We encourage you to have all the relevant information on hand when you ring. The more information you prepare, the faster we can help solve the problem. This information includes your Epson product manuals, type of computer, operating system, application programs, and any information you feel is required.

Transportation of Product

Epson recommends retaining product packaging for future transportation.

Where to Get Help

Help for Users in Singapore

Sources of information, support, and services available from Epson Singapore are:

World Wide Web

<http://www.epson.com.sg>

Information on product specifications, drivers for download, Frequently Asked Questions (FAQ), Sales Enquiries, and Technical Support via e-mail are available.

Epson HelpDesk

Toll Free: 800-120-5564

Our HelpDesk team can help you with the following over the phone:

- Sales enquiries and product information
- Product usage questions or problem troubleshooting
- Enquiries on repair service and warranty

Help for Users in Thailand

Contacts for information, support, and services are:

World Wide Web

<http://www.epson.co.th>

Information on product specifications, drivers for download, Frequently Asked Questions (FAQ), and e-mail are available.

Epson Hotline

Phone: 66-2685-9899

Email: support@eth.epson.co.th

Our Hotline team can help you with the following over the phone:

- Sales enquiries and product information
- Product usage questions or problems
- Enquiries on repair service and warranty

Help for Users in Vietnam

Contacts for information, support, and services are:

Epson Hotline

Phone(Ho Chi Minh City): 84-8-823-9239

Phone(Hanoi City): 84-4-3978-4785, 84-4-3978-4775

Where to Get Help

Epson Service Center

65 Truong Dinh Street, District 1, Hochiminh City, Vietnam.

29 Tue Tinh, Quan Hai Ba Trung, Hanoi City, Vietnam

Help for Users in Indonesia

Contacts for information, support, and services are:

World Wide Web

<http://www.epson.co.id>

- Information on product specifications, drivers for download
- Frequently Asked Questions (FAQ), Sales Enquiries, questions through e-mail

Epson Hotline

Phone: 62-21-572-4350

Fax: 62-21-572-4357

Our Hotline team can help you with the following over the phone or fax:

- Sales enquiries and product information
- Technical support

Epson Service Center

Province	Company Name	Address	Phone E-mail
DKI JAKARTA	ESS Jakarta MG. DUA	RUKO MANGGA DUA MALL NO. 48 JL. ARTERI MANGGA DUA - JAKARTA UTARA-DKI	(+6221)62301104 jkt-technical1@epson-indonesia.co.id
NORTH SUMATERA	ESC Medan	Kompleks Graha Niaga, Jl. Bambu II No. A-4, Medan- 20114	(+6261)42066090/42066091 mdn-technical@epson-indonesia.co.id
WEST JAWA	ESC Bandung	JL. CIHAMPELAS NO. 48A-BANDUNG JABAR 40116	(+6222)4207033 bdg-technical@epson-indonesia.co.id
DI YOGYAKARTA	ESC Yogyakarta	YAP Square, Blok A No.6 Jl. C Simanjutak YOGYAKARTA - DIY	(+62274)581065 ygy-technical@epson-indonesia.co.id
EAST JAWA	ESC Surabaya	HITECH MALL LT.2 BLOK A NO. 24 JL. KUSUMA BANGSA NO. 116 -118 - SURABAYA JATIM	(+6231)5355035 sby-technical@epson-indonesia.co.id
SOUTH SULAWESI	ESC Makassar	JL. GUNUNG BAWAKARAENG NO. 68E - MAKASSAR SULSEL	(+62411)328212 mksr-technical@epson-indonesia.co.id

Where to Get Help

Province	Company Name	Address	Phone E-mail
WEST KALIMANTAN	ESC Pontianak	JL. NUSA INDAH I NO. 40A PONTIANAK KALBAR 78117	(+62561)735507 pontianak-technical@epson-indonesia.co.id
PEKANBARU	ESC PEKANBARU	JL. TUANKU TAMBUSAI NO. 353 - PEKANBARU RIAU	(+62761)21420 pkb-technical@epson-indonesia.co.id
DKI JAKARTA	ESS JAKARTA KEIAI	WISMA KEIAI LT. 1 JL. JEND. SUDIRMAN KAV. 3 JAKPUS DKI JAKARTA	(+6221)5724335 ess.support@epson-indonesia.co.id
EAST JAWA	ESS SURABAYA	JL. JAWA NO. 2-4 KAV. 29, RUKO SURYA INTI, SURABAYA - JATIM	(+6231)5014949 esssby.support@epson-indonesia.co.id
BANTEN	ESS SERPONG	Ruko mall WTC MATAHARI no. 953 SERPONG - Banten	(+6221)53167051 esstag.support@epson-indonesia.co.id
CENTRAL JAWA	ESS SEMARANG	Komplek Ruko Metro Plaza Blok C20 , Jl. MT Haryono No 970 Semarang - Jawa tengah	(+6224)8313807 esssmg.support@epson-indonesia.co.id
EAST KALIMANTAN	ESC SAMARINDA	Jl. KH. Wahid Hasyim (M. Yamin) Kel. Sempaja Selatan Kec. Samarinda Utara Samarinda- Kalimantan Timur (samping kantor pos)	(+62541)7272904 escsmd.support@epson-indonesia.co.id
SOUTH SUMATERA	ESC PALEMBANG	Jl. H.M. Rasyid Nawawi no.249, kelurahan 9 ilir Palembang - Sumsel	(+62711)311330 escplg.support@epson-indonesia.co.id
EAST JAVA	ESC JEMBER	Jl. Panglima Besar Sudirman No.1 D JEMBER - JAWA TIMUR (Depan Balai Penelitian dan Pengolahan Kakao)	(+62331) 486468,488373 jmr-admin@epson-indonesia.co.id jmr-technical@epson-indonesia.co.id
NORTH SULAWESI	ESC MANADO	Tekno @Megamall, Megamall LG TK-21 Jl. Piere Tendean Kawasan Megamas Boulevard Manado 95111	(+62431)7210033 MND-ADMIN@EPSON-INDONESIA.CO.ID

For other cities not listed here, call the Hot Line: 08071137766.

Help for Users in Hong Kong

To obtain technical support as well as other after-sales services, users are welcome to contact Epson Hong Kong Limited.

Where to Get Help

Internet Home Page

<http://www.epson.com.hk>

Epson Hong Kong has established a local home page in both Chinese and English on the Internet to provide users with the following information:

- Product information
- Answers to Frequently Asked Questions (FAQs)
- Latest versions of Epson product drivers

Technical Support Hotline

You can also contact our technical staff at the following telephone and fax numbers:

Phone: 852-2827-8911

Fax: 852-2827-4383

Help for Users in Malaysia

Contacts for information, support, and services are:

World Wide Web

<http://www.epson.com.my>

- Information on product specifications, drivers for download
- Frequently Asked Questions (FAQ), Sales Enquiries, questions through e-mail

Epson Call Centre

Phone: +60 1800-8-17349

- Sales enquiries and product information
- Product usage questions or problems
- Enquiries on repair services and warranty

Head Office

Phone: 603-56288288

Fax: 603-5628 8388/603-5621 2088

Help for Users in India

Contacts for information, support, and services are:

World Wide Web

<http://www.epson.co.in>

Information on product specifications, drivers for download, and products enquiry are available.

Where to Get Help

Helpline

- Service, product information, and ordering consumables (BSNL Lines)
Toll-free number: 18004250011
Accessible 9am to 6pm, Monday through Saturday (Except public holidays)
- Service (CDMA & Mobile Users)
Toll-free number: 186030001600
Accessible 9am to 6pm, Monday through Saturday (Except public holidays)

Help for Users in the Philippines

To obtain technical support as well as other after sales services, users are welcome to contact the Epson Philippines Corporation at the telephone, fax numbers and e-mail address below:

World Wide Web

<http://www.epson.com.ph>

Information on product specifications, drivers for download, Frequently Asked Questions (FAQ), and E-mail Enquiries are available.

Epson Philippines Customer Care

Toll Free: (PLDT) 1800-1069-37766

Toll Free: (Digital) 1800-3-0037766

Metro Manila: (+632)441-9030

Web Site: <http://customercare.epson.com.ph>

E-mail: customercare@epc.epson.com.ph

Our Customer Care team can help you with the following over the phone:

- Sales enquiries and product information
- Product usage questions or problems
- Enquiries on repair service and warranty

Epson Philippines Corporation

Trunk Line: +632-706-2609

Fax: +632-706-2665