



ET-4550 User's Guide

Contents

ET-4550 User's Guide	13
Your Ink Tank System	14
Product Basics	15
Using the Control Panel	15
Control Panel Buttons and Lights	15
Status Icons	16
Entering Characters on the LCD Screen	17
Changing LCD Screen Language.....	17
Turning Off Control Panel Sounds.....	18
Adjusting the Screen Contrast.....	18
Product Parts Locations	19
Product Parts - Top and Front	20
Product Parts - Inside	23
Product Parts - Back.....	24
Using Eco Mode and Other Power Saving Settings	24
Changing the Eco Settings	25
Changing the Sleep Timer Settings	25
Changing the Power Off Timer Settings	26
Epson Connect Solutions for Smartphones, Tablets, and More	27
Using Epson Email Print	27
Using the Epson iPrint Mobile App	28
Using Epson Remote Print	28
Using Epson Scan to Cloud.....	29
Using AirPrint	29
Using Google Cloud Print.....	30
Setting Up Google Cloud Print on a Chromebook	31
Wi-Fi or Wired Networking	33
Wi-Fi Infrastructure Mode Setup.....	33
Selecting Wireless Network Settings From the Control Panel	34
Wi-Fi Direct Mode Setup	36

Enabling Wi-Fi Direct Mode	37
Wi-Fi Protected Setup (WPS).....	39
Using WPS to Connect to a Network	39
Printing a Network Status Sheet.....	40
Changing or Updating Network Connections	41
Accessing the Web Config Utility	41
Changing a USB Connection to a Wi-Fi Connection.....	41
Changing a Wi-Fi Connection to a Wired Network Connection.....	42
Connecting to a New Wi-Fi Router	42
Disabling Wi-Fi Features	43
Loading Paper	44
Loading Paper in the Cassette	44
Paper Loading Capacity	49
Available Epson Papers	51
Paper or Media Type Settings - Product Software.....	51
Selecting the Paper Settings - Control Panel	52
Paper Type Settings - Control Panel	53
Paper Source Settings.....	53
Selecting Universal Print Settings.....	53
Universal Print Settings Options	54
Placing Originals on the Product	56
Placing Originals on the Scanner Glass	56
Placing Originals in the Automatic Document Feeder	58
Copying.....	61
Copying Documents or Photos.....	61
Paper Size Settings - Copying.....	62
Copying Options.....	62
Printing from a Computer	64
Printing with Windows	64
Selecting Basic Print Settings - Windows	64
Print Quality Options - Windows	66
Multi-Page Printing Options - Windows.....	67

Selecting Double-sided Printing Settings - Windows	67
Double-sided Printing Options - Windows.....	70
Selecting Additional Layout and Print Options - Windows	71
Custom Color Correction Options - Windows.....	73
Image Options and Additional Settings - Windows.....	74
Header/Footer Settings - Windows	75
Selecting a Printing Preset - Windows.....	76
Selecting Extended Settings - Windows	77
Extended Settings - Windows	78
Printing Your Document or Photo - Windows.....	79
Checking Print Status - Windows.....	81
Selecting Default Print Settings - Windows.....	81
Changing the Language of the Printer Software Screens	82
Changing Automatic Update Options	83
Printing with OS X	84
Selecting Basic Print Settings - OS X	85
Print Quality Options - OS X.....	89
Print Options - OS X	89
Selecting Page Setup Settings - OS X.....	89
Selecting Print Layout Options - OS X.....	90
Selecting Double-sided Printing Settings - OS X	91
Double-sided Printing Options and Adjustments - OS X	92
Sizing Printed Images - OS X	93
Managing Color - OS X.....	94
Color Matching and Color Options - OS X.....	95
Selecting Printing Preferences - OS X.....	95
Printing Preferences - OS X.....	96
Printing Your Document or Photo - OS X.....	97
Checking Print Status - OS X.....	98
Cancelling Printing Using a Product Button.....	98
Scanning	99
Starting a Scan.....	99
Starting a Scan Using the Product Control Panel	99

Changing Default Scan Button Settings	100
Starting a Scan Using the Epson Scan Icon	101
Starting a Scan from a Scanning Program.....	103
Selecting Epson Scan Settings	105
Scan Modes.....	105
Selecting the Scan Mode.....	106
Scanning in Office Mode.....	106
Available Document Source Settings - Office Mode.....	108
Selecting a Scan Area - Office Mode	109
Available Image Adjustments - Office Mode	111
Scanning in Home Mode	112
Selecting a Scan Area - Home Mode	115
Available Image Adjustments - Home Mode	118
Selecting a Scan Size - Home Mode.....	119
Scanning in Professional Mode	122
Available Document Source Settings - Professional Mode	125
Available Image Types - Professional Mode	125
Selecting a Scan Area - Professional Mode	125
Available Image Adjustments - Professional Mode	128
Selecting a Scan Size - Professional Mode.....	130
Image Preview Guidelines.....	133
Scan Resolution Guidelines	133
Selecting Scan File Settings.....	135
Available Scanned File Types and Optional Settings.....	136
Scanning with OS X Using Image Capture.....	137
Available Scan Settings - OS X Image Capture.....	139
Scanning Special Projects.....	139
Scanning to a PDF File.....	140
Restoring Photo Colors as You Scan	143
Faxing.....	144
Connecting a Telephone or Answering Machine	144
Setting Up Fax Features	147
Setting Up Fax Features Using the Product Control Panel.....	147

Selecting Your Country or Region.....	148
Selecting the Date and Time.....	148
Using the Fax Setting Wizard.....	150
Selecting the Line Type.....	152
Setting the Number of Rings to Answer	153
Selecting Advanced Fax Settings	153
Basic Settings - Fax	154
Receive Settings - Fax.....	155
Output Settings - Fax	156
Security Settings - Fax.....	157
Printing Fax Reports	157
Fax Report Options.....	158
Setting Up Fax Features Using the Fax Utility - Windows.....	158
Setting Up Fax Features Using the Fax Utility - OS X.....	160
Setting Up Contacts and Contact Groups.....	161
Setting Up Contacts Using the Product Control Panel.....	162
Creating a Contact.....	162
Editing or Deleting a Contact	164
Creating a Contact Group	165
Editing or Deleting a Group.....	167
Setting Up Speed/Group Dial Lists Using the Fax Utility - Windows.....	169
Setting Up Speed/Group Dial Lists Using the Fax Utility - OS X.....	172
Sending Faxes	174
Sending Faxes from the Product Control Panel.....	174
Faxing from the Control Panel	174
Fax Send Settings.....	175
Dialing Fax Numbers from a Connected Telephone	177
Sending a Fax at a Specified Time	178
Sending Faxes Using the Fax Utility - Windows	179
Sending Faxes Using the Fax Utility - OS X.....	182
Receiving Faxes.....	185
Fax Reception	185
Receiving Faxes Automatically.....	186

Receiving Faxes Manually	186
Receiving a Fax by Polling	187
Refilling Ink	188
Ink Safety Precautions	188
Check Ink Levels	189
Checking Ink Levels	190
Checking Ink Levels with Windows.....	190
Checking Ink Levels with OS X.....	192
Disabling Special Offers with Windows	193
Purchase Epson Ink	194
Ink Bottle Part Numbers.....	194
Refilling the Ink Tanks	194
Adjusting Print Quality.....	200
Print Head Maintenance.....	200
Print Head Nozzle Check.....	200
Checking the Nozzles Using the Product Control Panel	200
Checking the Nozzles Using a Computer Utility	202
Print Head Cleaning	204
Cleaning the Print Head Using the Product Control Panel	205
Cleaning the Print Head Using a Computer Utility.....	206
Power Ink Flushing	209
Flushing the Ink Using a Computer Utility	209
Print Head Alignment	210
Aligning the Print Head Using the Product Control Panel	211
Aligning the Print Head Using a Computer Utility.....	212
Cleaning the Paper Path	214
Checking the Number of Sheets.....	215
Checking the Sheet Counter - Windows	215
Checking the Sheet Counter - OS X	216
Cleaning and Transporting Your Product	218
Cleaning Your Product	218
Transporting Your Product	220

Solving Problems	224
Checking for Software Updates	224
Product Status Messages	225
Running a Product Check	226
Resetting Control Panel Defaults	227
Solving Setup Problems	228
Noise After Filling the Ink	228
Software Installation Problems	229
Control Panel Setup Problems	229
USB Connection Problems	229
Solving Network Problems	230
Product Cannot Connect to a Wireless Router or Access Point	230
Cannot Print Over a Network	231
Network Software Cannot Find Product on a Network	232
Product Does Not Appear in OS X Printer Window	233
Cannot Print Over a Network	234
Cannot Scan Over a Network	235
Solving Copying Problems	236
Product Makes Noise, But Nothing Copies	236
Product Makes Noise When It Sits for a While	236
Solving Paper Problems	236
Paper Feeding Problems	237
Paper Jam Problems Inside the Product	237
Paper Jam Problems in the Paper Cassette	239
Paper Jam Problems in the Duplexer (Rear Cover)	241
Document Jams in the Automatic Document Feeder	243
Paper Ejection Problems	247
Solving Problems Printing from a Computer	247
Nothing Prints	248
Product Icon Does Not Appear in Windows Taskbar	248
Printing is Slow	249
Solving Page Layout and Content Problems	250
Inverted Image	251

Too Many Copies Print	251
Blank Pages Print	251
Incorrect Margins on Printout.....	252
Incorrect Characters Print.....	252
Incorrect Image Size or Position	253
Slanted Printout	253
Solving Print Quality Problems	254
White or Dark Lines in Printout	254
Blurry or Smearred Printout	255
Faint Printout or Printout Has Gaps	257
Grainy Printout.....	257
Incorrect Colors	258
Solving Scanning Problems	259
Scanning Software Does Not Operate Correctly	260
Cannot Start Epson Scan	260
Solving Scanned Image Quality Problems	261
Image Consists of a Few Dots Only.....	262
Line of Dots Appears in All Scanned Images	262
Straight Lines in an Image Appear Crooked	262
Image is Distorted or Blurry	263
Image Colors are Patchy at the Edges	263
Image is Too Dark	263
Back of Original Image Appears in Scanned Image	264
Ripple Patterns Appear in an Image	264
Image is Scanned Upside-Down	264
Scanned Image Colors Do Not Match Original Colors	264
Scan Area is Not Adjustable in Thumbnail Preview	265
Scanned Image Edges are Cropped	265
Solving Faxing Problems.....	265
Cannot Send or Receive Faxes	266
Cannot Receive Faxes with a Telephone Connected to Your Product	267
Message Appears Prompting You to Reset Ink Levels.....	268
Uninstall Your Product Software.....	268

Uninstalling Product Software - Windows	268
Uninstalling Product Software - OS X	269
Where to Get Help	270
Technical Specifications	272
Windows System Requirements	272
OS X System Requirements	273
Scanning Specifications	273
Paper Specifications	274
Printable Area Specifications	275
Ink Specifications	276
Fax Specifications	277
Dimension Specifications	278
Electrical Specifications	278
Environmental Specifications	278
Interface Specifications	279
Network Interface Specifications	279
Safety and Approvals Specifications	280
Notices	281
Important Safety Instructions	281
General Product Safety Instructions	281
Wireless Connection Safety Instructions	283
Telephone Equipment Safety Instructions	283
LCD Screen Safety Instructions	283
FCC Compliance Statement	284
Trademarks	286
Copyright Notice	287
A Note Concerning Responsible Use of Copyrighted Materials	287
Default Delay Times for Power Management for Epson Products	288
Copyright Attribution	288

ET-4550 User's Guide

Welcome to the ET-4550 *User's Guide*.

For a printable PDF copy of this guide, [click here](#).

Your Ink Tank System

You should visually check the ink levels in the product's ink tanks regularly. For optimum printing results, refill the ink tanks to the upper line at least once a year.

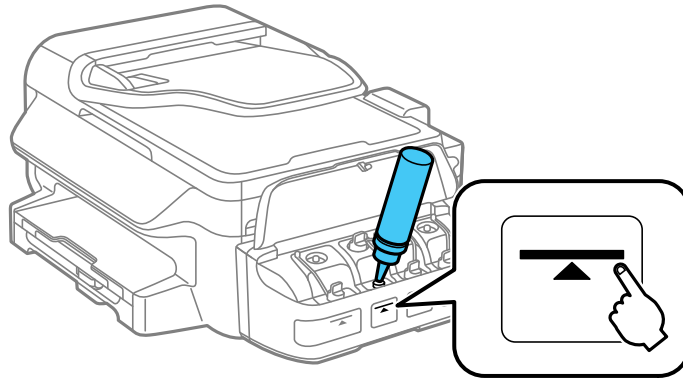

Note: The product has a low ink alert system. The accuracy of this system depends on the user refilling the ink tanks correctly. The product cannot directly measure the ink levels in the tanks; instead it estimates the amount of ink remaining by internally monitoring ink usage. The low ink alert system may generate inaccurate messages if the ink tanks are not refilled according to these instructions.

Visually check the ink levels in the product's ink tanks to confirm the actual ink levels. Continued use of the product when the ink is expended could damage the product.

To refill the ink tanks and reset the ink levels, click the link below.

Related tasks

[Refilling the Ink Tanks](#)

Product Basics

See these sections to learn about the basic features of your product.

[Using the Control Panel](#)

[Product Parts Locations](#)

[Using Eco Mode and Other Power Saving Settings](#)

[Epson Connect Solutions for Smartphones, Tablets, and More](#)

[Using AirPrint](#)

[Using Google Cloud Print](#)

Using the Control Panel

See these sections to learn about the control panel and select control panel settings.

[Control Panel Buttons and Lights](#)

[Entering Characters on the LCD Screen](#)

[Changing LCD Screen Language](#)







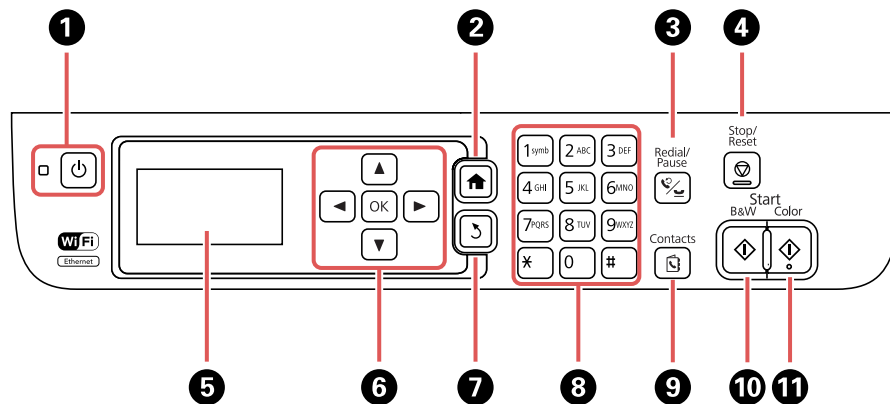

[Turning Off Control Panel Sounds](#)

[Adjusting the Screen Contrast](#)

Parent topic: [Product Basics](#)

Control Panel Buttons and Lights









- 1 The  power button and light
- 2 The  home button
- 3 The  **Redial/Pause** button
- 4 The  **Stop/Reset** button
- 5 The LCD screen
- 6 The arrow buttons and the **OK** button
- 7 The  back button
- 8 The numeric keypad
- 9 The  **Contacts** button
- 10 The **Start**  **B&W** button
- 11 The **Start**  **Color** button





Status Icons

Parent topic: [Using the Control Panel](#)

Status Icons

Status icons may be displayed on the LCD screen depending on the product's status.

Icons	Description
	Originals are detected in the ADF (Automatic Document Feeder)
	No Ethernet connection
	Ethernet connection has been established
	Wi-Fi network error has occurred or the product is searching for a connection
	Wi-Fi connection has been established; the number of bars indicates the connection's signal strength
	Ad hoc connection has been established
	Wi-Fi Direct mode connection has been established

Icons	Description
	Simple AP mode connection has been established
	Not connected to a Wi-Fi network
	Simple AP and Wi-Fi Direct modes are disabled
	Eco Mode setting is enabled

Parent topic: [Control Panel Buttons and Lights](#)

Entering Characters on the LCD Screen

Follow these guidelines to enter characters for passwords and other settings.

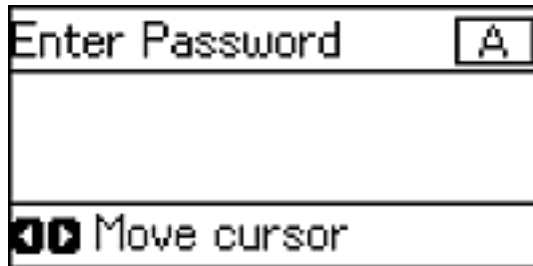

- To enter letters or symbols, press the buttons on the numeric keypad repeatedly to scroll through characters.
- To enter numbers or change the case of letters, press the up or down arrow button.
- To delete the previous character, press the left arrow button.
- To enter a space, press the right arrow button.

Parent topic: [Using the Control Panel](#)

Changing LCD Screen Language

You can change the language used on the LCD screen.

1. Press the up or down arrow button, select **Setup**, and press the **OK** button.

You see a screen like this:

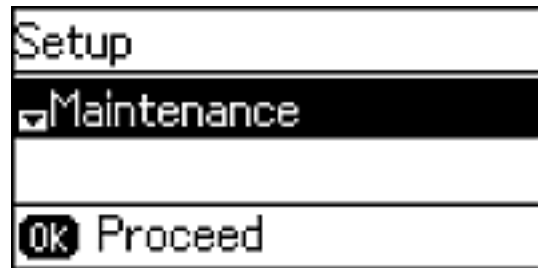

2. Press the down arrow button, select **Common Settings**, and press the **OK** button.
3. Press the down arrow button, select **Language**, and press the **OK** button.
4. Select a language and press the **OK** button.
5. Press the **Home** button to exit.

Parent topic: [Using the Control Panel](#)

Turning Off Control Panel Sounds

You can turn off the sound heard when you press buttons on the control panel.

1. Press the up or down arrow button, select **Setup**, and press the **OK** button.
2. Press the down arrow button, select **Common Settings**, and press the **OK** button.
3. Select **Sound** and press the **OK** button.
4. Select **Button Press** and press the **OK** button.
5. Press the down arrow button until the sound is turned off, then press the **OK** button.
6. Press the **Home** button to exit.

Parent topic: [Using the Control Panel](#)

Adjusting the Screen Contrast

You can adjust the contrast of the LCD screen.

1. Press the up or down arrow button, select **Setup**, and press the **OK** button.

You see a screen like this:

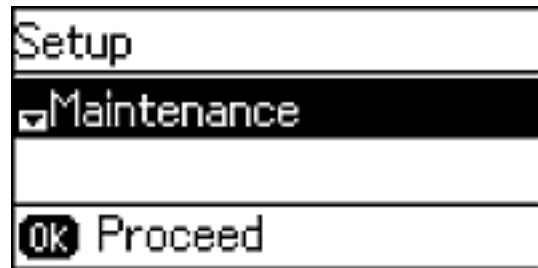

2. Press the down arrow button, select **Common Settings**, and press the **OK** button.
3. Select **LCD Contrast** and press the **OK** button.
4. Press the up or down arrow button to adjust the screen contrast.
5. Press the **OK** button.
6. Press the  home button to exit.

Parent topic: [Using the Control Panel](#)

Product Parts Locations

See these sections to identify the parts on your product.

[Product Parts - Top and Front](#)

[Product Parts - Inside](#)

[Product Parts - Back](#)

Parent topic: [Product Basics](#)

Product Parts - Top and Front

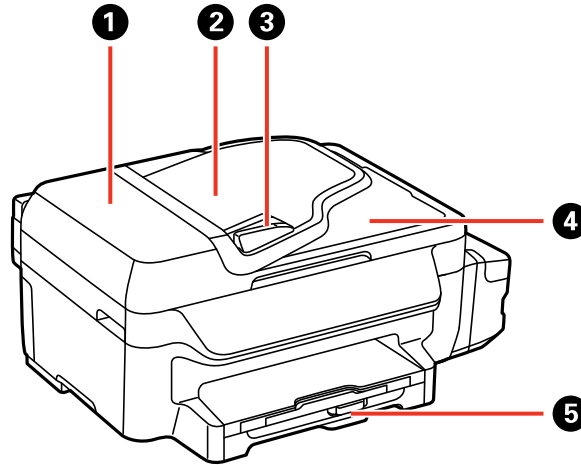

- 1 ADF (Automatic Document Feeder) cover
- 2 ADF input tray
- 3 ADF edge guide
- 4 ADF output tray
- 5 Paper cassette

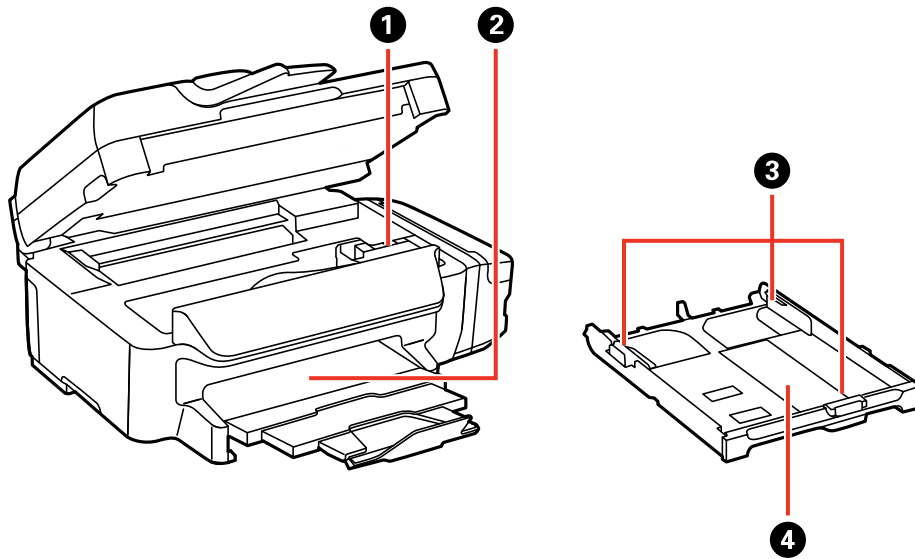

- 1 Print head
- 2 Output tray
- 3 Edge guides
- 4 Paper cassette

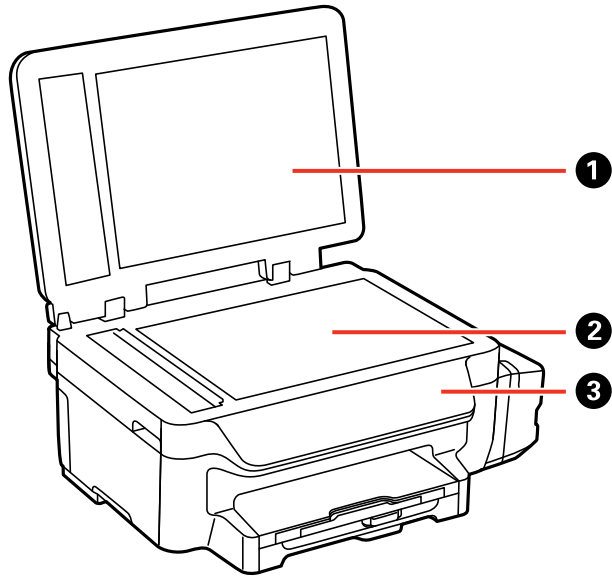

- 1 Document cover
- 2 Scanner glass
- 3 Control panel

Parent topic: [Product Parts Locations](#)

Product Parts - Inside

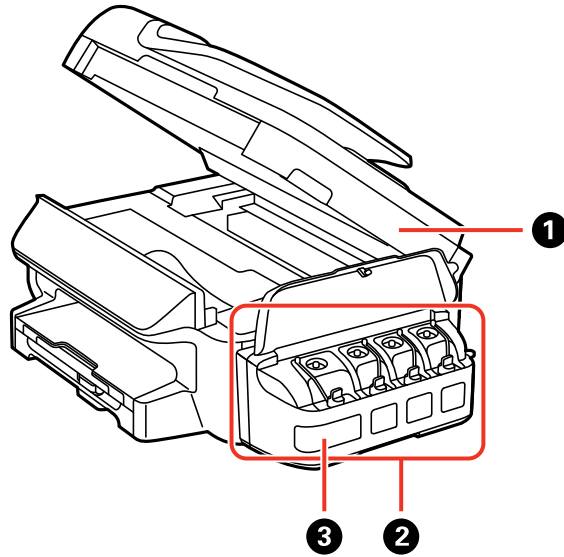

- 1 Scanner unit
- 2 Ink tank unit
- 3 Ink tanks

Parent topic: [Product Parts Locations](#)

Product Parts - Back

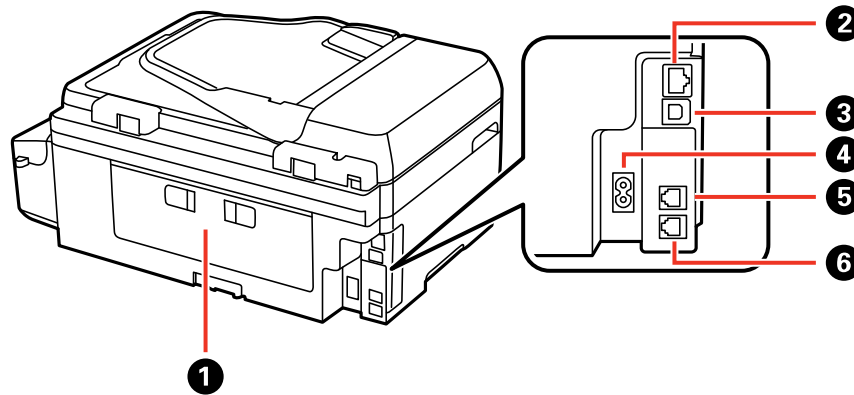

- 1 Rear cover
- 2 **LAN** port
- 3 **USB** port
- 4 AC inlet
- 5 **LINE** port
- 6 **EXT.** port

Parent topic: [Product Parts Locations](#)

Using Eco Mode and Other Power Saving Settings

Your product enters sleep mode automatically and turns off the LCD screen if it is not used for a period of time. You can make the time period shorter and select other options to save energy and resources.

[Changing the Eco Settings](#)

[Changing the Sleep Timer Settings](#)

[Changing the Power Off Timer Settings](#)

Parent topic: [Product Basics](#)

Changing the Eco Settings

You can use the product control panel to change the Eco settings.

Note: The Sleep Timer setting in Eco Mode overrides the Sleep Timer setting in Common Settings. This setting can be locked by an administrator. If you cannot access or change this setting, contact your administrator for assistance.

1. Press the up or down arrow button, select **Eco Mode**, and press the **OK** button.

You see a screen like this:

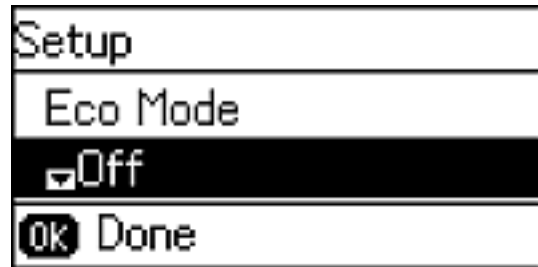

2. Select **On** and press the **OK** button.
3. Press the up arrow button to select **Yes**.
4. Change the settings as necessary.
5. Press the **OK** button to exit.

You see the  icon in the corner of the LCD screen to indicate that Eco settings are enabled.

Parent topic: [Using Eco Mode and Other Power Saving Settings](#)

Changing the Sleep Timer Settings

You can adjust the time period before your product enters sleep mode and turns off the LCD screen.

Note: The Sleep Timer setting in Eco Mode overrides the Sleep Timer setting in Common Settings. This setting can be locked by an administrator. If you cannot access or change this setting, contact your administrator for assistance.

1. Press the up or down arrow button, select **Setup**, and press the **OK** button.

2. Press the down arrow button, select **Common Settings**, and press the **OK** button.
3. Press the down arrow button, select **Sleep Timer**, and press the **OK** button.

You see a screen like this:

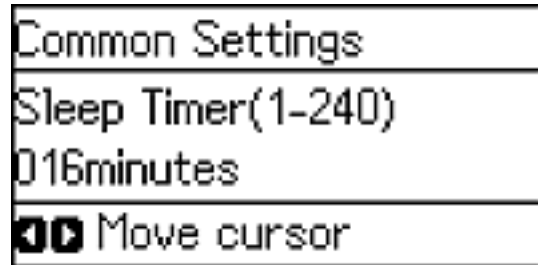

4. Use the numeric keypad to enter the number of minutes.
5. Press the left or right arrow button to move the cursor as necessary.
6. Press the **OK** button.

Parent topic: [Using Eco Mode and Other Power Saving Settings](#)

Changing the Power Off Timer Settings

You can have the product turn off automatically if it is not used for a specified period of time.

Note: This setting can be locked by an administrator. If you cannot access or change this setting, contact your administrator for assistance.

1. Press the down arrow button, select **Setup**, and press the **OK** button.

You see a screen like this:

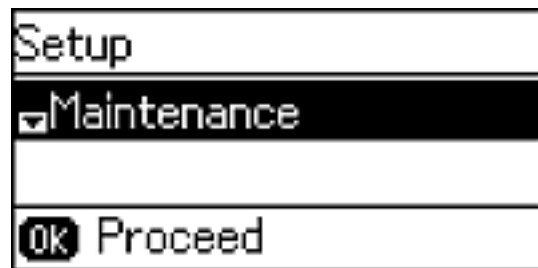

2. Press the down arrow button, select **Common Settings**, and press the **OK** button.
3. Press the down arrow button, select **Power Off Timer**, and press the **OK** button.
4. Press the down arrow button to select a time period between **30minutes** and **12h** (12 hours), and press the **OK** button.
5. Press the  home button to exit.

Parent topic: [Using Eco Mode and Other Power Saving Settings](#)

Epson Connect Solutions for Smartphones, Tablets, and More

You can print documents, photos, emails, and web pages from your home, office, or even across the globe. You can use your smartphone, tablet, or computer. Epson offers these solutions to print from anywhere: Epson Email Print, Epson iPrint Mobile App, Epson Remote Print, and Epson Scan to Cloud.

[Using Epson Email Print](#)

[Using the Epson iPrint Mobile App](#)

[Using Epson Remote Print](#)

[Using Epson Scan to Cloud](#)

Parent topic: [Product Basics](#)

Related tasks

[Using AirPrint](#)

[Using Google Cloud Print](#)

Using Epson Email Print

With Epson Email Print, you can print from any device that can send email, such as your smartphone, tablet, or laptop. Just activate your product's unique email address. When you want to print, attach a PDF, Microsoft Office document, or photo to an email and send it to your product.

1. Set up your product for network printing. See the link below.
2. If you did not already set up Email Print when you installed your product software, visit epson.com/connect to learn more about Email Print, check compatibility, and get detailed setup instructions.
3. Send an email with attachments to your product's Email Print address.

Note: Both the email and any attachments print by default. You can change these printing options by logging into your Epson Connect account.

Parent topic: [Epson Connect Solutions for Smartphones, Tablets, and More](#)

Related topics

[Wi-Fi or Wired Networking](#)

Using the Epson iPrint Mobile App

Use this free Apple and Android app to print to nearby Epson networked products. The Epson iPrint Mobile App lets you print PDFs, Microsoft Office documents, photos, and web pages over a wireless network. You can even scan and save a file on your device, send it as an email, or upload it to an online service such as Box, Dropbox, Evernote, or Google Drive.

1. Set up your product on a network. See the link below.
2. Visit epson.com/connect to learn more about Epson iPrint and check the compatibility of your mobile device.
3. Download Epson iPrint from the Apple App Store or Google Play.
4. Connect your mobile device to the same wireless network that your product is using.
5. Print from your mobile device to your Epson product.

Parent topic: [Epson Connect Solutions for Smartphones, Tablets, and More](#)

Related topics

[Wi-Fi or Wired Networking](#)

Using Epson Remote Print

With Epson Remote Print software, you can print to an Epson Email-enabled product anywhere in the world.

1. Set up your product for network printing. See the link below.
2. Visit epson.com/connect to learn more about Remote Print and how to download the software.
3. Download and install the Remote Print software.
4. Obtain the email address and optional access key of the Epson product you want to use for printing, and enter this address during Remote Print setup.
5. Select the print command in your application and choose the Remote Print driver for your Epson product.

Parent topic: [Epson Connect Solutions for Smartphones, Tablets, and More](#)

Related topics

[Wi-Fi or Wired Networking](#)

Using Epson Scan to Cloud

The Epson Scan to Cloud service sends your scanned files to a destination that you have registered with Epson Connect.

1. Set up your product for network scanning. See the link below.
2. Visit epson.com/connect for instructions on registering an account and your product with Epson Connect.
3. After registering, sign in to the Epson Connect web page with the email address and password you selected.
4. Select **Destination List** for Scan to Cloud.
5. Click **Add**, then follow the instructions on the screen to create your destination list.
6. When you're ready to scan, select the setting for the Scan to Cloud service on your product control panel.

Parent topic: [Epson Connect Solutions for Smartphones, Tablets, and More](#)

Related tasks

[Starting a Scan Using the Product Control Panel](#)

Related topics

[Wi-Fi or Wired Networking](#)

Using AirPrint

AirPrint enables instant wireless printing from iPhone, iPad, and iPod touch with the latest version of iOS, and Mac with the latest version of OS X.



1. Load paper in your product.
2. Set up your product for wireless printing. See the link below.
3. Connect your Apple device to the same wireless network that your product is using.
4. Print from your device to your product.

Note: For details, see the AirPrint page on the Apple website.

Parent topic: [Product Basics](#)

Related topics

[Wi-Fi or Wired Networking](#)

[Epson Connect Solutions for Smartphones, Tablets, and More](#)

Using Google Cloud Print

With a Google Account, you can print from your Apple or Android device to your Epson product. You can also print from Chromebooks and the Google Chrome browser without drivers or cables.

Set up your Epson product for network printing. See the link below.

Note: Make sure your Epson printer and computer are connected to the same network before starting the Google Cloud Print setup.

1. Connect your device to the same network that your Epson product is using.
2. Print a network status sheet.
3. Locate your product's IP address on the network status sheet.
4. Enter the IP address into the address bar of a web browser.
5. Select the **Google Cloud Print Services** option.

Note: If you don't see the **Google Cloud Print Services** option, turn your product off and back on. If the option still doesn't appear, select the **Firmware Update** option and follow the on-screen instructions to update your product.

6. Click **Register**.
7. Select the checkbox to agree to the Usage Advisory and click **Next**.
8. Click **OK** to launch the sign-in page.
A separate browser window opens.
9. Enter your Google Account username and password and click **Sign in**, or, if you don't have an account, click **Sign up for a new Google Account** and follow the on-screen instructions.
10. Click **Finish printer registration** to complete setup and print a test page.

Your product is now linked to your Google Account and can be accessed from any Chromebook, computer, Apple or Android device with Internet access. Visit [Epson Support](#) for more information on using Google Cloud Print, or the [Google Cloud Print](#) website for a list of [supported apps](#).

[Setting Up Google Cloud Print on a Chromebook](#)

Parent topic: [Product Basics](#)

Related topics

[Wi-Fi or Wired Networking](#)

[Epson Connect Solutions for Smartphones, Tablets, and More](#)

Setting Up Google Cloud Print on a Chromebook

With a Google Account, you can print from a Chromebook without drivers or cables.

Set up your Epson product for network printing. See the link below.

Note: Make sure your Epson product is connected to your wireless network before starting the Google Cloud Print setup.

1. Turn on your Chromebook and connect it to the same wireless network as your product.

Note: See your Chromebook's documentation for details on connecting to a network.

2. Do one of the following:
 - Click **Add to Cloud Print** in the notification that appears in the corner of your Chromebook screen.

Note: If you do not see a notification, check to see if a number appears in the status area at the lower-right corner of the screen. Click this number to open the notifications menu, then click **Add to Cloud Print**.

- Open a web browser and enter **chrome://devices** in the address bar. Skip to step 4.
 - If you see a registration confirmation screen instead, click **Register**.
3. Click **Add Device**.
 4. Click the **Register** button that appears next to your product.
 5. Click **Register** on the confirmation screen. Your product's LCD screen displays a confirmation message.

6. Select **OK** or press the **OK** button on your product to confirm the Google Cloud Print connection and print a test page.

Your product is now linked to your Google Account and can be accessed from any Chromebook, iPhone, or Android phone with Internet access. For more information on using Google Cloud Print, visit [Epson Support](#).

Parent topic: [Using Google Cloud Print](#)

Related topics

[Wi-Fi or Wired Networking](#)

Wi-Fi or Wired Networking

See these sections to use your product on a Wi-Fi or wired network.

[Wi-Fi Infrastructure Mode Setup](#)

[Wi-Fi Direct Mode Setup](#)

[Wi-Fi Protected Setup \(WPS\)](#)

[Printing a Network Status Sheet](#)

[Changing or Updating Network Connections](#)

Wi-Fi Infrastructure Mode Setup

You can set up your product to communicate with your computer using a wireless router or access point. The wireless router or access point can be connected to your computer over a wireless or wired network.

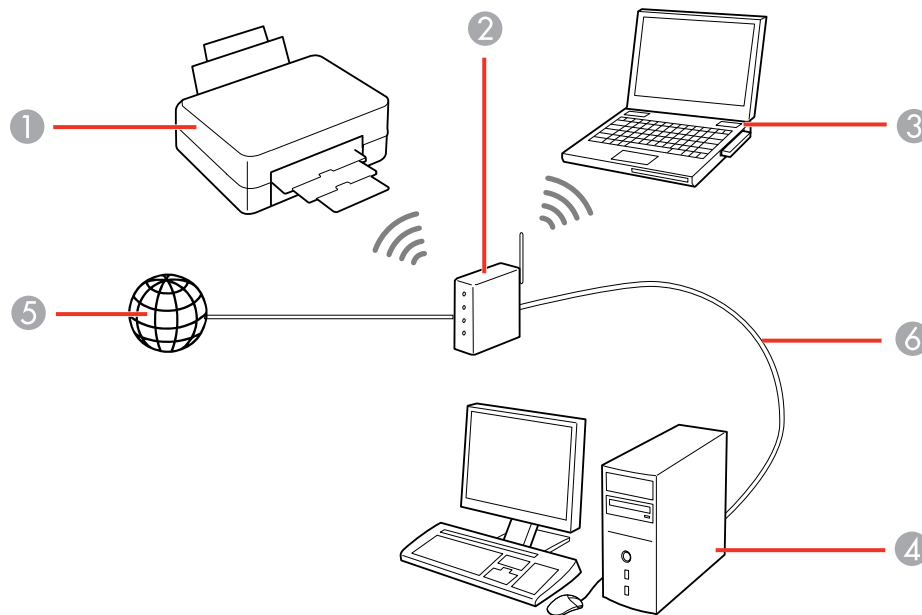

- 1 Epson product
- 2 Wireless router or access point

- 3 Computer with a wireless interface
- 4 Computer
- 5 Internet
- 6 Ethernet cable (used only for wired connection to the wireless router or access point)

Selecting Wireless Network Settings From the Control Panel

Parent topic: [Wi-Fi or Wired Networking](#)

Selecting Wireless Network Settings From the Control Panel

You can select or change wireless network settings using your product control panel.

To install your product on a wireless network, follow the instructions on the *Start Here* sheet and install the necessary software. The installer program guides you through network setup.

Note: Breakdown or repair of this product may cause loss of fax and network data and settings. Epson is not responsible for backing up or recovering data and settings during or after the warranty period. We recommend that you make your own backup or print out your fax and network data and settings.

1. Press the up or down arrow button, select **Wi-Fi Setup**, and press the **OK** button.

You see this screen:



2. Select **Wi-Fi Setup Wizard** and press the **OK** button.
3. Select the name of your wireless network and press the **OK** button.

Note: To enter the wireless network name manually, select **Other Networks** and press the **OK** button. Use the product's numeric keypad to enter your network name.

4. Enter your wireless password using the numeric keypad.

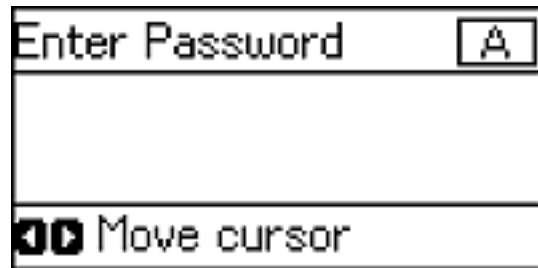

Note: The network name and password are case sensitive. Be sure to correctly enter uppercase and lowercase letters, and numeric or special characters.

- To enter letters or symbols, press the buttons on the numeric keypad to scroll through characters.
- To enter numbers or change the case of letters, press the up or down arrow button.
- To delete the previous character, press the left arrow button.

5. Press the **OK** button when you finish entering your password.
6. Confirm the displayed network settings and press the **OK** button to save them.

Note: If you need to change a setting, press the  back button.

7. If you want to print a network setup report, press one of the **Start** buttons. (Otherwise, press the **OK** button.)

If the network connection is successful, the  Wi-Fi icon appears in the upper-right corner of the LCD screen.

Parent topic: [Wi-Fi Infrastructure Mode Setup](#)

Related topics

[Changing or Updating Network Connections](#)

Wi-Fi Direct Mode Setup

You can set up your product to communicate directly with your computer or another device without requiring a wireless router or access point.

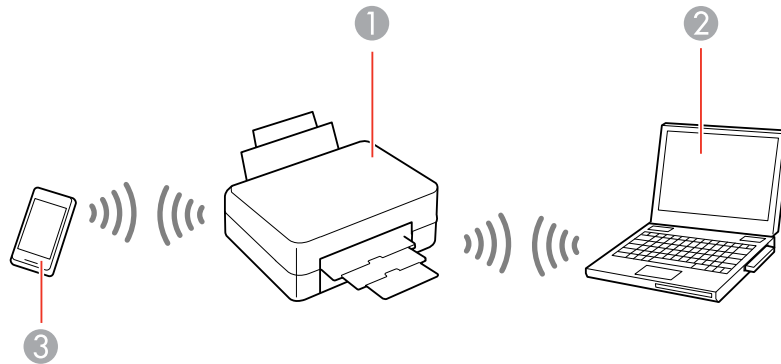

- 1 Epson product
- 2 Computer with a wireless interface
- 3 Other wireless device

You can select one of these modes to communicate with your computer or device:

Access point mode

The product itself acts as the network access point for up to 4 devices. When operating in this mode, your product displays an **AP** connection symbol on the LCD screen.

Peer-to-peer mode

The product communicates one-to-one with another Wi-Fi Direct capable device. When operating in this mode, your product displays a **Direct** or **D** connection symbol on the LCD screen.

To disconnect a peer-to-peer mode connection, release the connection to your product from your computer or other device.

To enable peer-to-peer mode, you must select it from the Web Config Utility, under **WiFi/Network Settings > Services > Wi-Fi Direct**.

[Enabling Wi-Fi Direct Mode](#)

Parent topic: [Wi-Fi or Wired Networking](#)

Enabling Wi-Fi Direct Mode

You can enable Wi-Fi Direct mode to allow direct communication between your product and a computer or other devices without a wireless router or access point.

1. Press the up or down arrow button, select **Wi-Fi Setup**, and press the **OK** button.

You see this screen:



2. Press the down arrow button, select **Wi-Fi Direct Setup**, and press the **OK** button.
3. Press the down arrow button, select **Connection Setup**, and press the **OK** button.
4. Press the down arrow button, select **Change Password**, and press the **OK** button.
5. Press the up arrow button to select **Yes**.

Note: If you have already connected devices or computers to your product via Wi-Fi Direct, they will be disconnected when you change the password.

6. Enter a Wi-Fi Direct password using the numeric keypad.

Note: Your password must be at least 8 and no more than 22 characters long.

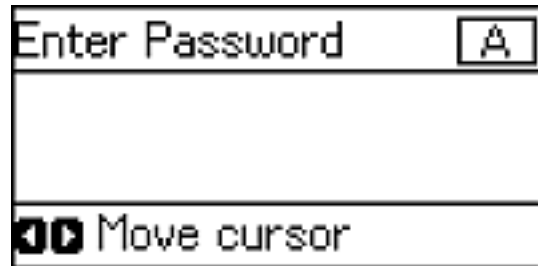

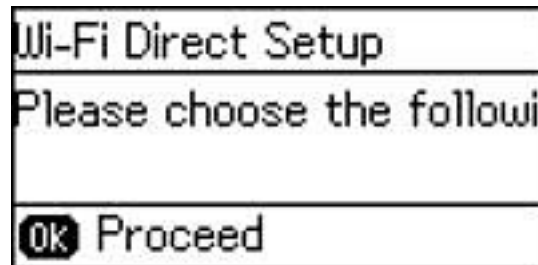

- To enter letters or symbols, press the buttons on the numeric keypad repeatedly to scroll through characters.
 - To enter numbers or change the case of letters, press the up or down arrow button.
 - To delete the previous character, press the left arrow button.
7. Press the **OK** button when you're finished entering your password.

You see this screen:



8. Press the **OK** button to view the SSID (Wi-Fi network name) and password.
9. Use your computer or wireless device to select the Wi-Fi network name (SSID) displayed on the LCD screen, and enter the password shown.
10. Press the **OK** button to exit.

You see the  connection symbol on the LCD screen and should be able to print directly to your product from your computer or device.

Note: If the  connection symbol is not displayed on the LCD screen, Wi-Fi Direct mode is not enabled. Repeat these steps to try again.

Parent topic: [Wi-Fi Direct Mode Setup](#)

Wi-Fi Protected Setup (WPS)

If your network uses a WPS-enabled wireless router or access point, you can quickly connect your product to the network using Wi-Fi Protected Setup (WPS).

Note: To check if your router is WPS-enabled, look for a button labeled **WPS** on your router or access point. If there is no hardware button, there may be a virtual WPS button in the software for the device. Check your network product documentation for details.

[Using WPS to Connect to a Network](#)

Parent topic: [Wi-Fi or Wired Networking](#)

Using WPS to Connect to a Network

If you have a WPS-enabled wireless router or access point, you can use Wi-Fi Protected Setup (WPS) to connect your product to the network.

1. Press the up or down arrow button, select **Wi-Fi Setup**, and press the **OK** button.

You see this screen:



2. Press the down arrow button, select **Push Button Setup (WPS)**, and press the **OK** button.

3. Follow the instructions on the LCD screen to complete WPS setup.
4. Press the **OK** button to return to the Home screen.

If the network connection is successful, the  Wi-Fi icon appears in the upper-right corner of the LCD screen.

Parent topic: [Wi-Fi Protected Setup \(WPS\)](#)

Printing a Network Status Sheet

You can print a network status sheet to help you determine the causes of any problems you may have using your product on a network.

1. Press the up or down arrow button, select **Setup**, and press the **OK** button.

You see this screen:

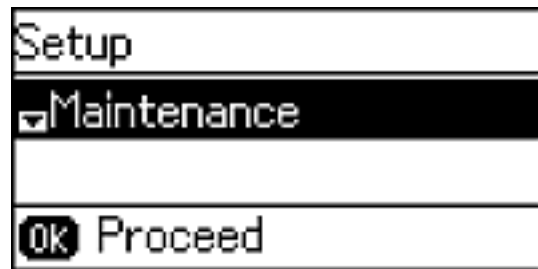

2. Press the down arrow button, select **Network Settings**, and press the **OK** button.
3. Press the down arrow button, select **Network Status**, and press the **OK** button.
4. Press the down arrow button, select **Print Status Sheet**, and press the **OK** button.

You see a screen like this:

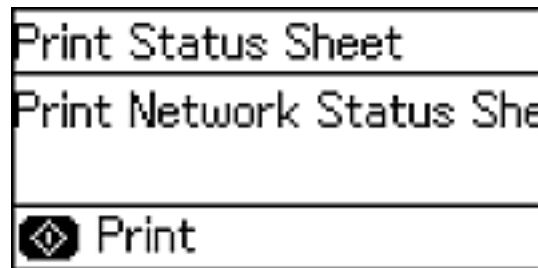

5. Press one of the **Start** buttons to print the network status sheet.

Examine the settings shown on the network status sheet to diagnose any problems you have.

Parent topic: [Wi-Fi or Wired Networking](#)

Changing or Updating Network Connections

See these sections to change or update how your product connects to a network.

[Accessing the Web Config Utility](#)

[Changing a USB Connection to a Wi-Fi Connection](#)

[Changing a Wi-Fi Connection to a Wired Network Connection](#)

[Connecting to a New Wi-Fi Router](#)

[Disabling Wi-Fi Features](#)

Parent topic: [Wi-Fi or Wired Networking](#)

Related tasks

[Selecting Wireless Network Settings From the Control Panel](#)

Accessing the Web Config Utility

You can select your product's network settings and confirm its operating status using a web browser. You do this by accessing your product's built-in Web Config utility from a computer or other device that is connected to the same network as your product.

1. Print a network status sheet.
2. Locate the IP Address for your product that is listed on the network status sheet.
3. On a computer or other device connected to the same network as your product, open a web browser.
4. Enter your product's IP address into the address bar.

You see the available Web Config utility options.

Parent topic: [Changing or Updating Network Connections](#)

Related tasks

[Printing a Network Status Sheet](#)

Changing a USB Connection to a Wi-Fi Connection

If you have already connected your product to your computer using a USB connection, you can change to a Wi-Fi connection.

1. Disconnect the USB cable from your product.
2. Uninstall your product software.
3. Download and install your product software from the Epson website using the instructions on the *Start Here* sheet.

Parent topic: [Changing or Updating Network Connections](#)

Changing a Wi-Fi Connection to a Wired Network Connection

If you have already connected your product to your computer wirelessly, you can change to a wired network connection if necessary.

1. Disable your product's Wi-Fi features.
2. Connect one end of an Ethernet network cable to the product's **LAN** port.
3. Connect the other end to any available LAN port on your router or access point.
4. Uninstall your product software.
5. Download and install your product software from the Epson website.
6. Follow the on-screen instructions to install the software.
7. When you see the Select Your Connection screen, select **Wired network connection**.
8. If you see a Select Setup Option screen, select **Set up printer for the first time**.
9. Continue following the rest of the on-screen instructions.

Parent topic: [Changing or Updating Network Connections](#)

Related tasks

[Disabling Wi-Fi Features](#)

Connecting to a New Wi-Fi Router

If you change the wireless router you have been using on your network, you need to update your product's Wi-Fi connection to the new router.

Note: If you switch to a 5 GHz wireless router, set the router to operate in dual band (2.4 GHz and 5 GHz) mode. See your router documentation for instructions.

1. Do one of the following:
 - **Windows:** Uninstall your product software.
 - **OS X:** Go to the next step.

2. Download and install your product software from the Epson website using the instructions on the *Start Here* sheet.

Parent topic: [Changing or Updating Network Connections](#)

Disabling Wi-Fi Features

You may need to disable your product's Wi-Fi features if you change your network connection type or need to solve a problem with your network connection.

Note: Before disabling Wi-Fi features, make a note of your product's SSID (network name) and password, and any network settings selected for the Epson Connect services you may use.

1. Press the up or down arrow button, select **Wi-Fi Setup**, and press the **OK** button.

You see this screen:



2. Press the down arrow button, select **Disable Wi-Fi**, and press the **OK** button.
3. Press the up arrow button to disable Wi-Fi.

Parent topic: [Changing or Updating Network Connections](#)

Loading Paper

Before you print, load paper for the type of printing you will do.

[Loading Paper in the Cassette](#)

[Paper Loading Capacity](#)

[Available Epson Papers](#)

[Paper or Media Type Settings - Product Software](#)

[Selecting the Paper Settings - Control Panel](#)

Loading Paper in the Cassette

You can print documents on a variety of paper types and sizes.

1. Close the paper stopper and output tray, if necessary.

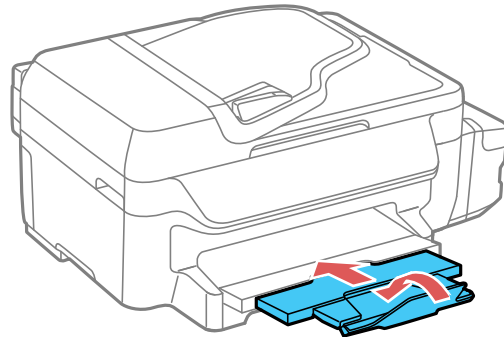

2. Pull out the paper cassette.

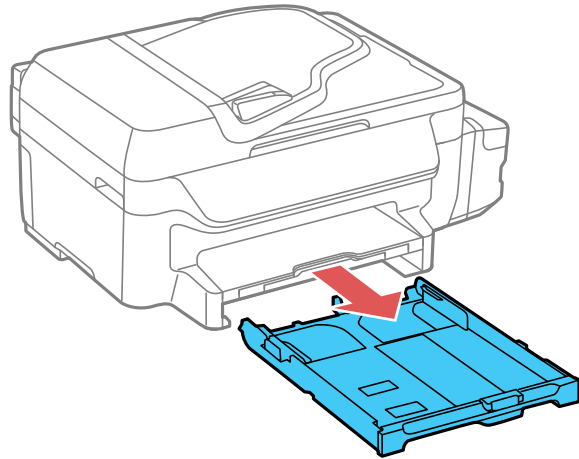

3. Slide the edge guides outward.

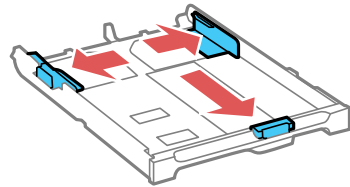

Note: If you are using legal-size paper or larger, press the button and extend the paper cassette.

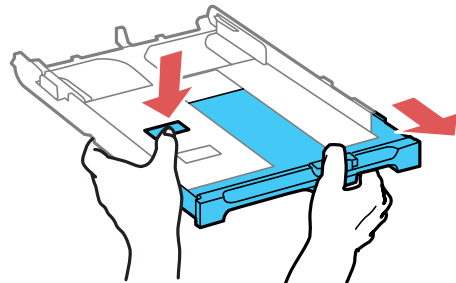

4. Slide the edge guide to your paper size.

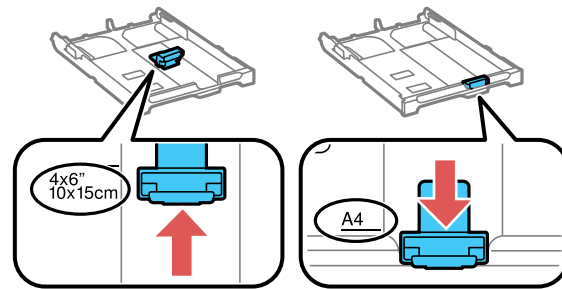

5. Do one of the following:

- Insert paper in the cassette with the glossy or printable side facedown.

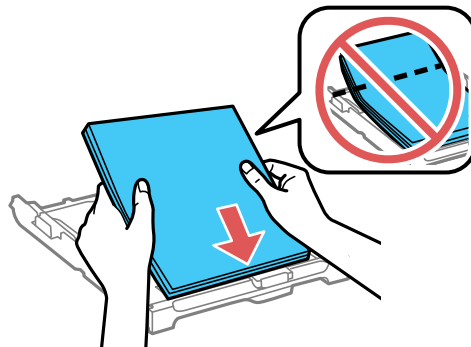

- Insert up to 10 envelopes, printable side facedown and flap edge left, as shown.

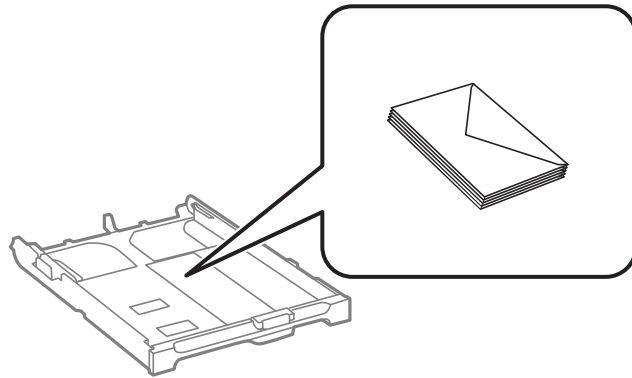

- Load a sheet of loose-leaf or other paper with holes as shown.

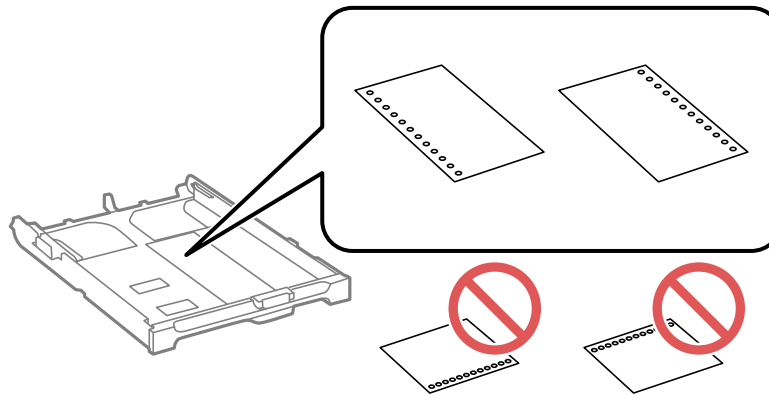

Note: Do not select automatic 2-sided printing for this type of paper.

Note: Make sure the paper is loaded against the front edge guide and not sticking out from the rear end of the cassette.

6. Slide the edge guides against the paper, but not too tightly.

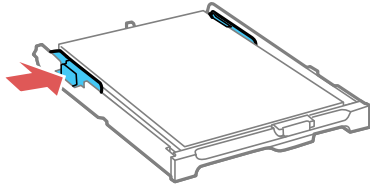

Note: Make sure the paper fits under the tabs on the edge guides.

7. Keep the cassette flat as you insert it.

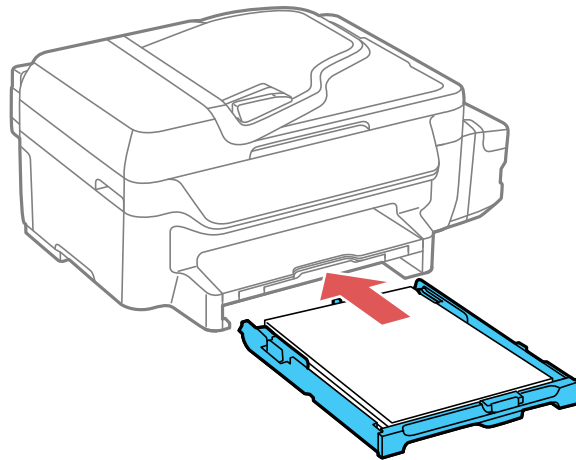

Note: The paper may slide forward slightly as you insert the cassette. This is normal.

8. If prompted by the product's LCD screen, select the size and type of the paper you loaded and press the **OK** button.

9. Extend the output tray and open the paper stopper.

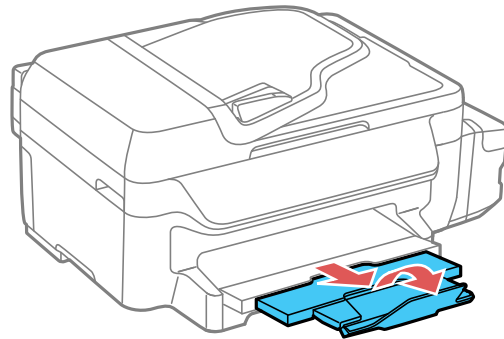

Note: If you are using legal-size or longer paper, do not open the paper stopper. Do not remove or insert the paper cassette during printing.

Always follow these paper loading guidelines:

- Load only the recommended number of sheets.
- Load paper short edge first and printable side facedown.
- Make sure the paper is under the tabs on the edge guides and not sticking out from the rear end of the cassette.
- If you have trouble loading a stack of envelopes, press each envelope flat before loading it or load one envelope at a time.
- If print quality declines when printing multiple envelopes, try loading one envelope at a time.
- Load letterhead or pre-printed paper top edge first.
- Check the paper package for any additional loading instructions.

Parent topic: [Loading Paper](#)

Related references

[Paper Loading Capacity](#)

[Paper Specifications](#)

Paper Loading Capacity

See the table here for the loading capacity of the paper cassettes.

Paper type	Paper size	Load up to this many sheets
Plain paper*	Letter (8.5 × 11 inches [216 × 279 mm])	Up to the arrow mark on the edge guide
	A4 (8.3 × 11.7 inches [210 × 297 mm])	
	A6 (4.1 × 5.8 inches [105 × 148 mm])	
	Half Letter (5.5 × 8.5 inches [140 × 216 mm])	
	Legal (8.5 × 14 inches [216 × 356 mm])	30 sheets
Epson Bright White Paper*	Letter (8.5 × 11 inches [216 × 279 mm])	120 sheets
Epson Premium Photo Paper Glossy	Letter (8.5 × 11 inches [216 × 279 mm])	20 sheets
	8 × 10 inches (203 × 254 mm)	
	5 × 7 inches (127 × 178 mm)	
	4 × 6 inches (102 × 152 mm)	
Epson Presentation Paper Matte	Letter (8.5 × 11 inches [216 × 279 mm])	80 sheets
Epson Premium Presentation Paper Matte	Letter (8.5 × 11 inches [216 × 279 mm])	20 sheets
	8 × 10 inches (203 × 254 mm)	
Envelopes	No. 10 (4.1 × 9.5 inches [105 × 241 mm])	10 envelopes

* You can print 2-sided print jobs automatically or manually. Load up to 30 Letter (8.5 × 11 inches [216 × 279 mm]) or smaller sized sheets for manual 2-sided print jobs. Load 1 sheet of Legal (8.5 × 14 inches [216 × 356 mm]) sized paper for manual 2-sided print jobs.

Parent topic: [Loading Paper](#)

Available Epson Papers

You can purchase genuine Epson ink and paper at epson.com/ink3 (U.S. sales) or epson.ca (Canadian sales). You can also purchase supplies from an Epson authorized reseller. To find the nearest one, call 800-GO-EPSON (800-463-7766).

Note: Paper/media availability varies by country.

Paper Type	Size	Part number	Sheet count
Epson Bright White Paper	Letter (8.5 × 11 inches [216 × 279 mm])	S041586	500
Epson Premium Presentation Paper Matte	8 × 10 inches (203 × 254 mm)	S041467	50
	Letter (8.5 × 11 inches [216 × 279 mm])	S041257 S042180	50 100
Epson Presentation Paper Matte	Letter (8.5 × 11 inches [216 × 279 mm])	S041062	100
	Legal (8.5 × 14 inches [216 × 356 mm])	S041067	100
Epson Premium Photo Paper Glossy	4 × 6 inches (102 × 152 mm)	S041808	40
		S041727	100
	5 × 7 inches (127 × 178 mm)	S041464	20
	8 × 10 inches (203 × 254 mm)	S041465	20
	Letter (8.5 × 11 inches [216 × 279 mm])	S042183 S041667	25 50

Parent topic: [Loading Paper](#)

Paper or Media Type Settings - Product Software

For this paper	Select this Paper Type or Media Type setting
Plain paper Epson Bright White Paper	Plain Paper/Bright White Paper

For this paper	Select this Paper Type or Media Type setting
Epson Premium Photo Paper Glossy	Premium Photo Paper Glossy
Epson Presentation Paper Matte Epson Premium Presentation Paper Matte	Premium Presentation Paper Matte
Envelope	Envelope

Parent topic: [Loading Paper](#)

Selecting the Paper Settings - Control Panel

You can change the default paper size and paper type using the control panel on the product.

1. Press the up or down arrow button, select **Setup**, and press the **OK** button.

You see this screen:

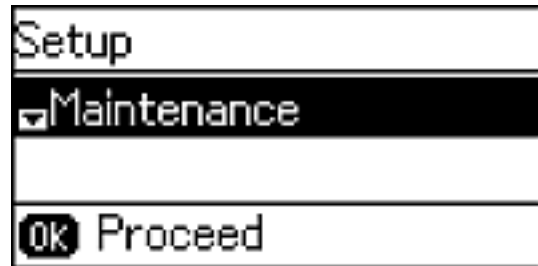

2. Select **Paper Setup** and press the **OK** button.
3. Press the **OK** button again.
4. Select the paper size you loaded and press the **OK** button.
5. Select the paper type you loaded and press the **OK** button.
6. Press the back button.
7. Press the up or down arrow button, select **Printer Settings**, and press the **OK** button.
8. Press the **OK** button again to select **Paper Source Settings**.
9. Select the paper source settings you want to use and press the **OK** button.
10. Press the home button to return to the home screen.

[Paper Type Settings - Control Panel](#)

[Paper Source Settings](#)

[Selecting Universal Print Settings](#)

Parent topic: [Loading Paper](#)

Paper Type Settings - Control Panel

For this paper	Select this Paper Type setting
Plain paper Epson Bright White Paper	Plain Paper
Epson Premium Photo Paper Glossy	Prem. Glossy
Epson Presentation Paper Matte Epson Premium Presentation Paper Matte	Prem. Matte
Envelope	Envelope

Parent topic: [Selecting the Paper Settings - Control Panel](#)

Paper Source Settings

Select the paper source settings you want to use for your printed jobs.

Paper Source Settings	Available settings	Description
A4/Letter Auto Switching	On (Auto)	If Letter or A4-size paper is selected for printing and the selected paper size is not loaded, the product attempts to print on an alternate paper size (Letter for A4 or A4 for Letter).
	Off	
Error Notice	Paper Size Notice	Select On to display an error message when the paper size and type settings for each paper source and the copy/print settings in each mode do not match.
	Paper Type Notice	

Parent topic: [Selecting the Paper Settings - Control Panel](#)

Selecting Universal Print Settings

You can change the default universal print settings using the product control panel.

1. Press the up or down arrow buttons, select **Setup**, and press the **OK** button.

You see this screen:

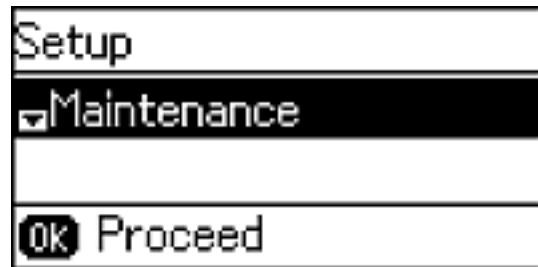

2. Press the down arrow button, select **Universal Print Settings**, and press the **OK** button.

You see this screen:

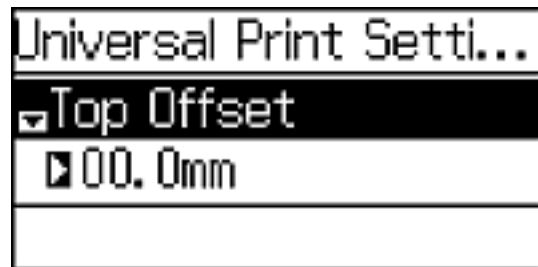

3. Adjust the settings as necessary.
4. When you are finished, press the ↵ back button to return to the Home screen.

[Universal Print Settings Options](#)

Parent topic: [Selecting the Paper Settings - Control Panel](#)

Universal Print Settings Options

Select the universal print settings you want to use.

Universal Print Settings option	Available settings	Description
Top Offset	—	Adjusts the top or left margin.
Left Offset		
Top Offset in Back	—	Adjusts the top or left margin of the back page when performing double-sided printing.
Left Offset in Back		
Check Paper Width	On Off	Select On to check the paper width before printing. This prevents printing beyond the edges of the paper when the paper size settings are wrong, but may reduce the printing speed.
Dry Time	Standard Long Longer	Select the drying time when printing double-sided.
Skip Blank Page	On	Select On to skip blank pages automatically.
	Off	

Parent topic: [Selecting Universal Print Settings](#)

Placing Originals on the Product

Follow the instructions here to place your original documents or photos on the product.

Caution: Do not place anything on top of your product or use its cover as a writing surface to avoid damaging it.

[Placing Originals on the Scanner Glass](#)

[Placing Originals in the Automatic Document Feeder](#)

Placing Originals on the Scanner Glass

You can place originals up to this size on the scanner glass: Letter (8.5 × 11 inches [216 × 279 mm]) or A4 (8.3 × 11.7 inches [210 × 297 mm]).

1. Open the document cover.

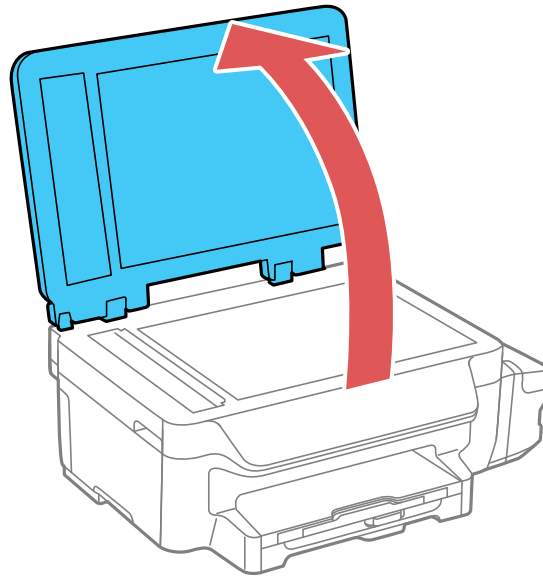

2. Place your original facedown on the scanner glass with the top facing into the corner. Slide the original to the edges of the indicated corner.

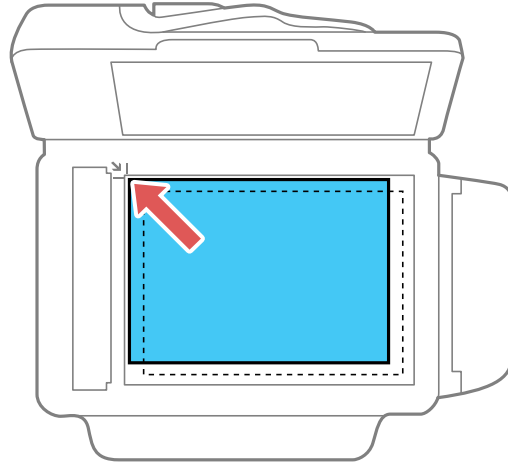

Note: You can place multiple originals on the scanner glass. Just make sure they are at least 0.8 inch (20 mm) away from each other.

Note: The edges of your original may be cropped by 0.06 inch (1.5 mm) from the edge of the scanner glass. If you are scanning in Full Auto mode or using thumbnail preview in another mode in Epson Scan, the edges of your original may be cropped by about 0.2 inch (4.5 mm) from the top and side edges. Manually position your original away from the edges to prevent cropping.

3. Close the document cover gently to keep your original in place.

Note: If you place originals on the scanner glass and loaded in the ADF, the originals loaded in the ADF are processed first.

Parent topic: [Placing Originals on the Product](#)

Related topics

[Copying](#)

[Scanning](#)

[Faxing](#)

Placing Originals in the Automatic Document Feeder

You can place multi-page original documents in the Automatic Document Feeder (ADF). Make sure the originals meet the Automatic Document Feeder specifications before loading them.

Caution: Make sure your originals are not creased or folded, and do not contain holes, staples, tape, or other materials that could obstruct the feeder.

1. Slide the ADF edge guide outward.

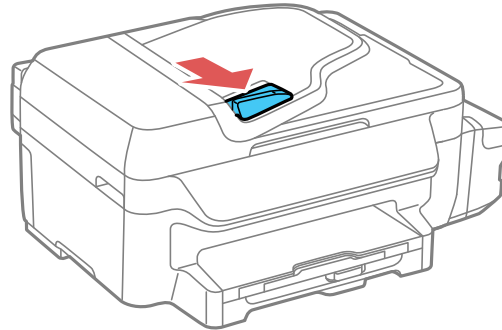

2. Fan your stack of originals and tap them gently on a flat surface to even the edges.

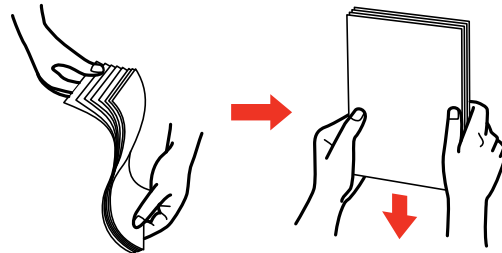

3. Insert the originals into the ADF faceup and top-edge first.

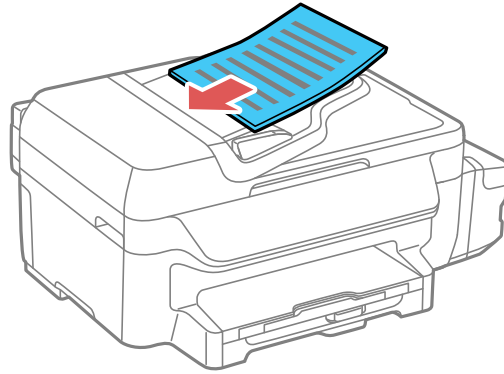

The **ADF** icon on the LCD screen appears.

4. Slide the ADF edge guide against the originals, but not too tightly.

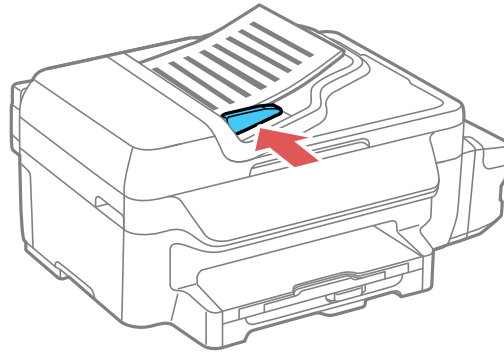

Note: If you place originals on the scanner glass and loaded in the ADF, the originals loaded in the ADF are processed first.

Parent topic: [Placing Originals on the Product](#)

Related topics

[Copying](#)

[Scanning](#)

Faxing

Copying

See the information here to copy documents or photos using your product.

Note: Copies may not be exactly the same size as your originals.

[Copying Documents or Photos](#)

[Paper Size Settings - Copying](#)

[Copying Options](#)

Copying Documents or Photos

You can copy documents or photos onto various sizes and types of paper, including Epson special papers.

1. Place your original document or photo on the scanner glass, or place multi-page documents in the ADF.
2. Load the paper you want to print on.
3. Press the down arrow button, select **Copy**, and press the **OK** button.

You see a screen like this:

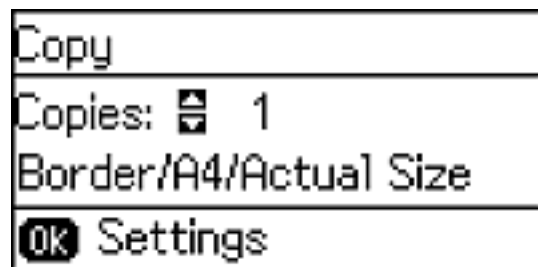

4. To print more than one copy, press a number key or the up or down arrow button.
5. Press the **OK** button to view and change additional copy settings, if necessary. Then press the back button.
6. When you are ready to copy, press one of the **Start** buttons.

Note: To cancel printing, press the  **Stop/Reset** button or select **Cancel**.

Parent topic: [Copying](#)

Related references

[Paper Loading Capacity](#)

[Available Epson Papers](#)

Related tasks

[Loading Paper in the Cassette](#)

Related topics

[Placing Originals on the Product](#)

Paper Size Settings - Copying

Select the **Document Size** setting that matches the paper you loaded.

- Letter (8.5 × 11 inches [216 × 279 mm])
- Legal (8.5 × 14 inches [216 × 356 mm]) (ADF only)
- A4 (8.3 × 11.7 inches [210 × 297 mm])

Parent topic: [Copying](#)

Copying Options

Select the copying options you want to use for your copies.

Note: Not all options or settings may be available, depending on other copying settings.

Copying option	Available settings	Description
Layout	With Border	Leaves a small margin around the image or document
	2-up	Copies multiple page documents onto one sheet. After selecting either one of these options, select Settings and change the Document Orientation setting if necessary.
	ID Card	Copies both sides of an ID card onto one side of a sheet of paper
Document Size	Various sizes	Select the document size of your original

Copying option	Available settings	Description
Zoom	Custom Size	Automatically sizes the image by the percentage you select
	Actual Size	Copies at 100% size
	Auto Fit Page	Automatically sizes the image to fit the selected paper size
	Legal->Letter	Automatically converts from legal-size to letter-size
2-Sided	Off	
	1>2-Sided	
Document Orientation	Portrait	Specifies the orientation of your originals
	Landscape	
Quality	Text	Specifies the document type of your originals and selects the quality of your copies
	Text (Best)	
	Text & Image	
	Text & Image (Best)	
Density	Varying levels	Adjusts the lightness or darkness of copies

Note: Remove the originals after scanning or copying. If you leave originals on the scanner glass for a long time, they may stick to the glass.

Parent topic: [Copying](#)

Printing from a Computer

Before printing from your computer, make sure you have set up your product and installed its software as described on the *Start Here* sheet.

Note: If you have an Internet connection, it is a good idea to check for updates to your product software on Epson's support website. If you see a Software Update screen, select **Enable automatic checking** and click **OK**. The update scans your system to see if you have the latest product software. Follow the on-screen instructions.

[Printing with Windows](#)

[Printing with OS X](#)

[Cancelling Printing Using a Product Button](#)

Printing with Windows

You can print with your product using any Windows application, as described in these sections.

[Selecting Basic Print Settings - Windows](#)

[Selecting Double-sided Printing Settings - Windows](#)

[Selecting Additional Layout and Print Options - Windows](#)

[Selecting a Printing Preset - Windows](#)

[Selecting Extended Settings - Windows](#)

[Printing Your Document or Photo - Windows](#)

[Selecting Default Print Settings - Windows](#)

[Changing Automatic Update Options](#)

Parent topic: [Printing from a Computer](#)

Selecting Basic Print Settings - Windows

Select the basic settings for the document or photo you want to print.

1. Open a photo or document for printing.
2. Select the print command in your application.

Note: You may need to select a print icon on your screen, the **Print** option in the **File** menu, or another command. See your application's help utility for details.

3. If necessary, select your product name as the printer you want to use.

Note: You may also need to select **Properties** or **Preferences** to view your print settings.

You see the Main tab of your printer settings window:

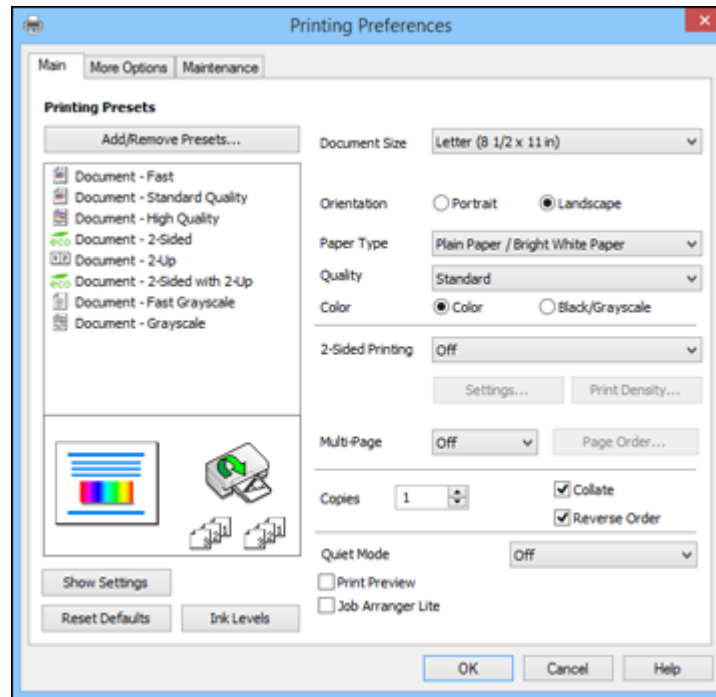

4. Select the size of the paper you loaded as the **Document Size** setting.

Note: You can also select the **User-Defined** setting to create a custom paper size.

5. Select the orientation of your document.

Note: If you are printing an envelope, select **Landscape**.

6. Select the type of paper you loaded as the **Paper Type** setting.

Note: The setting may not exactly match the name of your paper. Check the paper type settings list for details.

7. Select the **Quality** setting that matches the print quality you want to use.
8. Select a Color option:
 - To print a color document or photo, select the **Color** setting.
 - To print text and graphics in black or shades of gray, select the **Black/Grayscale** setting.
9. To print on both sides of the paper, select a **2-Sided Printing** option.
10. To print multiple pages on one sheet of paper, or print one image on multiple sheets of paper, select one of the settings in the **Multi-Page** menu and select the printing options you want.
11. To print multiple copies and arrange their print order, select the **Copies** options.
12. To reduce noise during printing when you select **Plain Paper/Bright White Paper**, select **Quiet Mode** (printing will be slower).
13. To preview your job before printing, select **Print Preview**.
14. To save your print job as a project that can be modified and combined with other print jobs, select **Job Arranger Lite**.

[Print Quality Options - Windows](#)

[Multi-Page Printing Options - Windows](#)

Parent topic: [Printing with Windows](#)

Related references

[Paper or Media Type Settings - Product Software](#)

Related tasks

[Selecting Double-sided Printing Settings - Windows](#)

Print Quality Options - Windows

You can select any of the available Quality options to fine-tune the quality of your print. Some settings may be unavailable, depending on the paper type and border setting you have chosen.

Draft

For draft printing on plain paper.

Standard

For everyday text and image printing.

High

For photos and graphics with high print quality.

More Settings

Opens a window that lets you choose among levels of speed and quality.

Parent topic: [Selecting Basic Print Settings - Windows](#)

Multi-Page Printing Options - Windows

You can select any of the available options in the Multi-Page menu to set up your multi-page print job.

2-Up and 4-Up

Prints 2 or 4 pages on one sheet of paper. Click the **Page Order** button to select page layout and border options.

2×1 Poster, 2×2 Poster, 3×3 Poster, 4×4 Poster

Prints one image on multiple sheets of paper to create a larger poster. Click the **Settings** button to select image layout and guideline options.

Parent topic: [Selecting Basic Print Settings - Windows](#)

Selecting Double-sided Printing Settings - Windows

You can print on both sides of the paper by selecting one of the **2-Sided Printing** options on the Main tab.

Note: Some options may be pre-selected or unavailable, depending on other settings you have chosen or if you are accessing the product over a network.

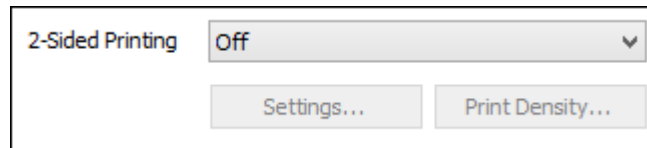

1. Select one of the following options for **2-Sided Printing**:
 - **Auto (Long-edge binding)** to print your double-sided print job by automatically flipping the paper on the long edge.
 - **Auto (Short-edge binding)** to print your double-sided print job by automatically flipping the paper on the short edge.

- **Manual (Long-edge binding)** to print your double-sided print job by printing one side and prompting you to flip the paper over on the long edge to print the other side (recommended for paper types that do not support automatic duplexing).
 - **Manual (Short-edge binding)** to print your double-sided print job by printing one side and prompting you to flip the paper over on the short edge to print the other side (recommended for paper types that do not support automatic duplexing).
2. Click the **Settings** button.

You see this window:

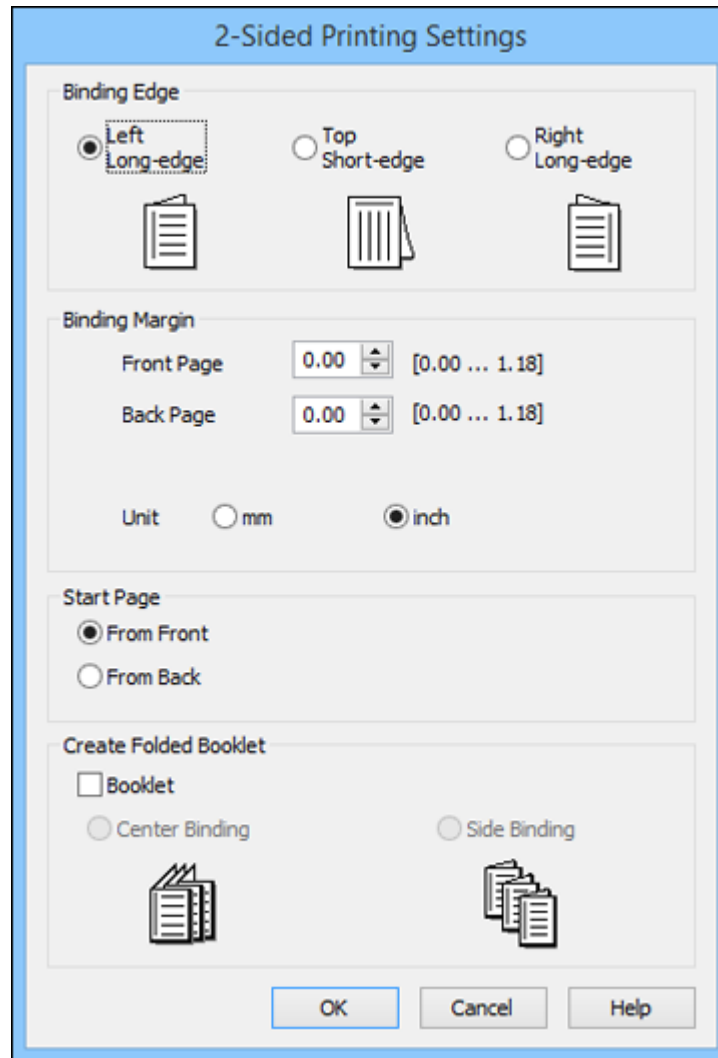

3. Select the double-sided printing options you want to use.
4. Click **OK** to return to the Main tab.
5. Click the **Print Density** button.

You see this window:

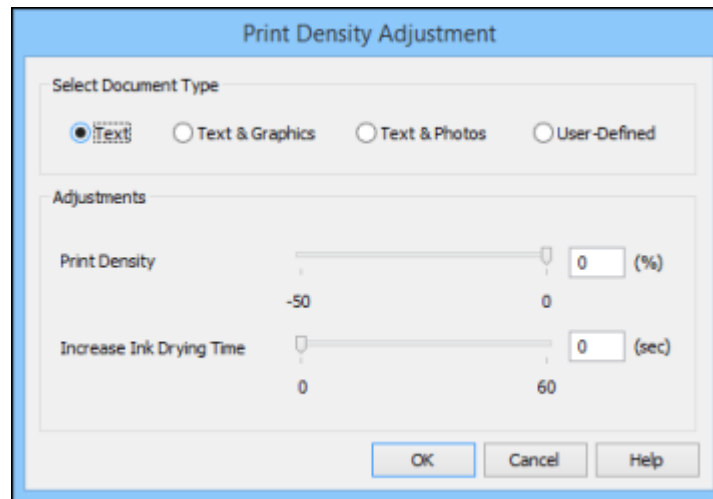

6. Select the type of document you are printing as the Document Type setting. The software automatically sets the **Adjustments** options for that document type.
7. If necessary, select the **Adjustments** options you want to use.
8. Click **OK** to return to the Main tab.
9. Print a test copy of your double-sided document to test the selected settings.
10. Follow any instructions displayed on the screen during printing.

[Double-sided Printing Options - Windows](#)

Parent topic: [Printing with Windows](#)

Related tasks

[Selecting Basic Print Settings - Windows](#)

Double-sided Printing Options - Windows

You can select any of the available options on the 2-Sided Printing Settings window to set up your double-sided print job.

Binding Edge Options

Select a setting that orients double-sided print binding in the desired direction.

Binding Margin Options

Select options that define a wider margin to allow for binding.

Start Page

Selects whether printing starts on the front or back page.

Create Folded Booklet Options

Select the **Booklet** checkbox and a binding option to print double-sided pages as a booklet.

Parent topic: [Selecting Double-sided Printing Settings - Windows](#)

Selecting Additional Layout and Print Options - Windows

You can select a variety of additional layout and printing options for your document or photo on the More Options tab.

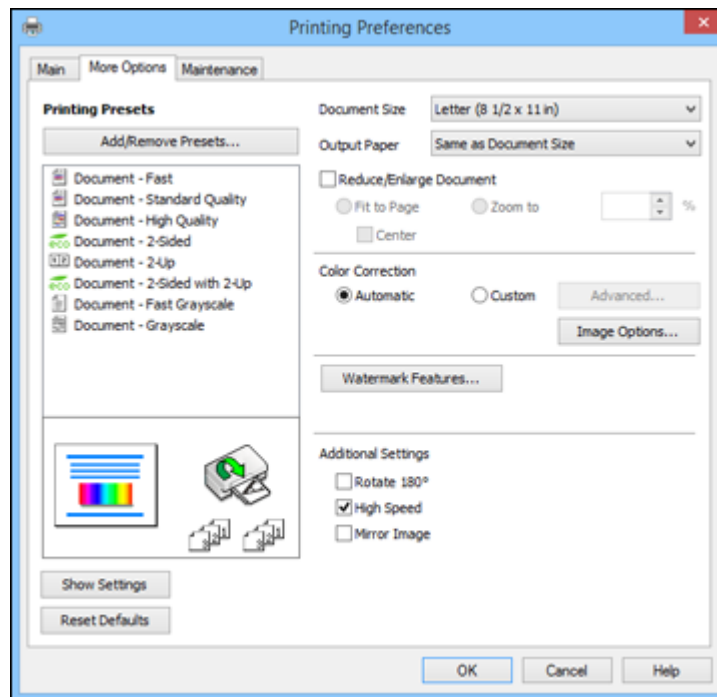

1. To change the size of your printed document or photo, select the **Reduce/Enlarge Document** checkbox and select one of these sizing options:
 - Select the **Fit to Page** option to size your image to fit the paper you loaded. Select the size of the your document or photo as the **Document Size** setting, and the size of your paper as the **Output Paper** setting. If you want to center your image on the paper, select the **Center** option.
 - Select the **Zoom to** option to reduce or enlarge your document or photo by a specific percentage. Select the percentage in the % menu.
2. Select one of the following Color Correction options:
 - Select **Automatic** to automatically adjust the sharpness, brightness, contrast, and color saturation for your image.
 - Select **Custom** and click the **Advanced** button to manually adjust the color correction settings or turn off color management in your printer software.
 - Select **Image Options** to access additional settings for improving printed images.

Note: You can also select **Color Universal Print** settings.
3. To add the following features, click the **Watermark Features** button:
 - **Anti-Copy Pattern:** adds a watermark that only appears when your printout is copied.
 - **Watermark:** adds a visible watermark to your printout.

Note: Click the **Add/Delete** button to create your own watermark, and click the **Settings** button to customize the watermark.

 - **Header/Footer:** adds information such as the date and time to the top or bottom of your printout.

Note: Click the **Settings** button to customize the text and location of the header or footer.
4. Select any of the Additional Settings options to customize your print.

[Custom Color Correction Options - Windows](#)

[Image Options and Additional Settings - Windows](#)

[Header/Footer Settings - Windows](#)

Parent topic: [Printing with Windows](#)

Custom Color Correction Options - Windows

You can select any of the available options in the Color Correction window to customize the image colors for your print job.

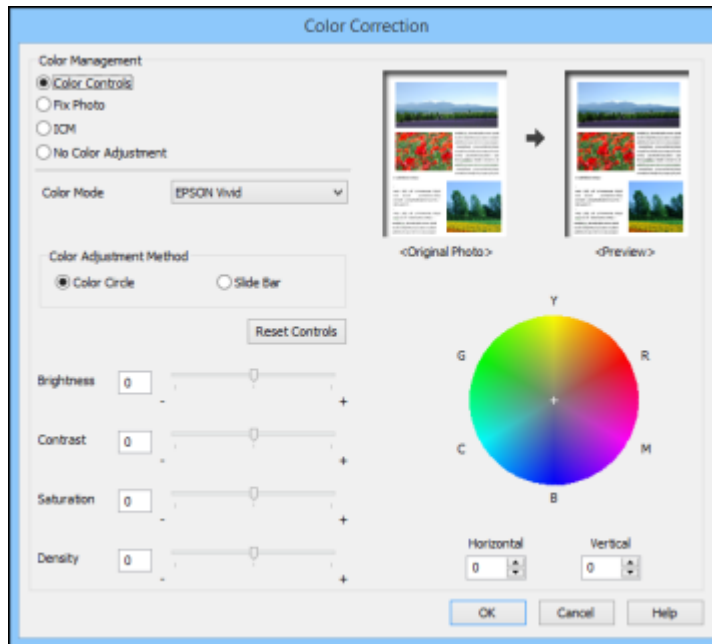

Color Controls

Lets you select a **Color Mode** setting, individual settings for **Brightness**, **Contrast**, **Saturation**, and **Density**, and individual color tones. Depending on the selected color mode, you can also adjust the midtone density using the **Gamma** setting.

Fix Photo

Improves the color, contrast, and sharpness of flawed photos.

Note: Fix Photo uses a sophisticated face recognition technology to optimize photos that include faces. For this to work, both eyes and the nose must be visible in the subject's face. If your photo includes a face with an intentional color cast, such as a statue, you may want to turn off **Fix Photo** to retain the special color effects.

ICM

Lets you manage color using installed color printing profiles.

No Color Adjustment

Turns off color management in your printer software so you can manage color using only your application software.

Parent topic: [Selecting Additional Layout and Print Options - Windows](#)

Image Options and Additional Settings - Windows

You can select any of the Image Options and Additional Settings to customize your print. Some options may be pre-selected or unavailable, depending on other settings you have chosen.

Image Options**Emphasize Text**

Adjusts the weight of printed text to increase readability.

Emphasize Thin Lines

Adjusts the weight of printed lines to increase visibility.

Edge Smoothing

Smooths jagged edges in low-resolution images such as screen captures or images from the Web.

Fix Red-Eye

Reduces or removes red-eye in photos.

Print Text in Black

Prints colored text in black.

For Color Text

Prints colored text on a background pattern or underlined.

For Color Graphs and Images

Prints colored graphics and images with overlay patterns.

For Color Text, Graphs, and Images

Prints colored text, graphics, and images with overlay patterns.

Enhancement Options

Specifies Color Universal Print enhancement settings for text, graphics, and images.

Additional Settings Options**Rotate 180°**

Prints the image rotated 180° from its original orientation.

High Speed

Speeds up printing but may reduce print quality.

Mirror Image

Flips the printed image left to right.

Parent topic: [Selecting Additional Layout and Print Options - Windows](#)

Header/Footer Settings - Windows

You can select any of the Header/Footer Settings options to add headers or footers when you print. The items are available to print at the top or bottom of your pages, in either the left, right, or center of the page.

Note: These settings are not saved with your document.

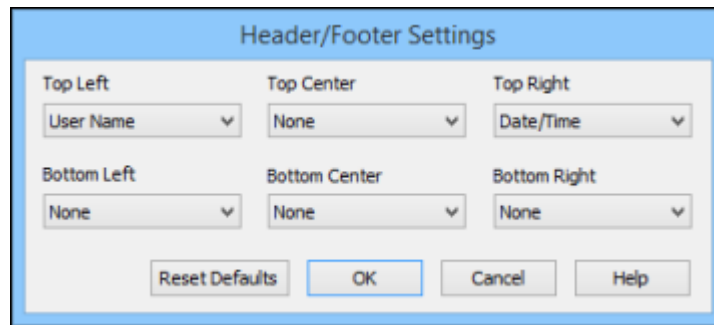

You can select to print the following information:

- User Name
- Computer Name
- Date
- Date/Time
- Collate Number (copy number)

Note: The user name, computer name, date, and time come from the Windows Control Panel on your computer.

Parent topic: [Selecting Additional Layout and Print Options - Windows](#)

Selecting a Printing Preset - Windows

For quick access to common groups of print settings, you can select a printing preset on the Main or More Options tab.

Note: You can create your own preset by clicking the **Add/Remove Presets** button.

1. Click the **Main** or **More Options** tab.

You see the available **Printing Presets** on the left:

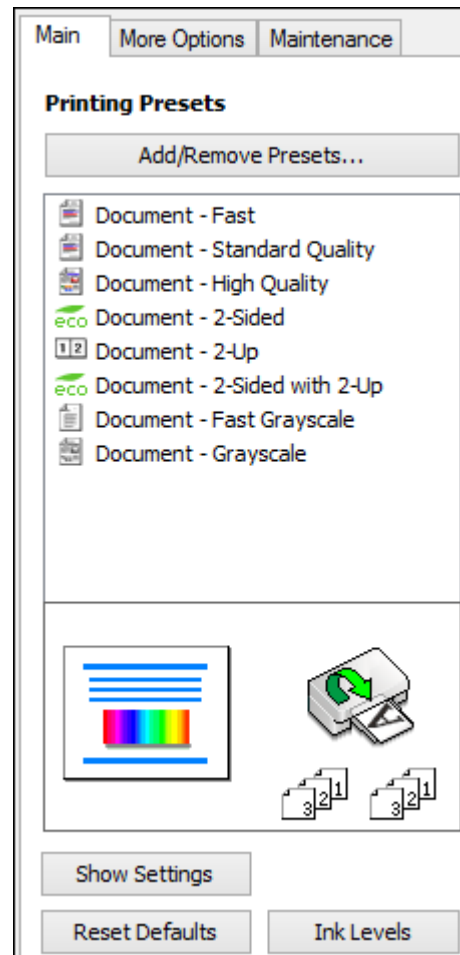

2. Place your cursor over one of the **Printing Presets** to view its list of settings.
3. Click on a preset to change its settings, or use any of the available options on the screen to control your printing presets.
4. To choose a preset for printing, select it.
5. Click **OK**.

Parent topic: [Printing with Windows](#)

Selecting Extended Settings - Windows

You can select additional settings that apply to all the print jobs you send to your product.

1. Access the Windows Desktop and right-click the product icon in the Windows taskbar.
2. Select **Printer Settings**.
3. Click the **Maintenance** tab.

You see the maintenance options:

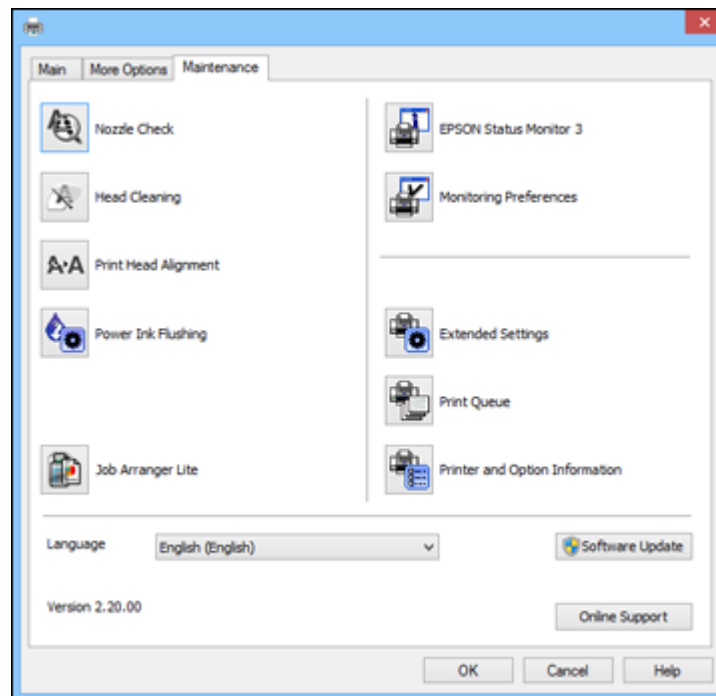

4. Click the **Extended Settings** button.

You see this window:

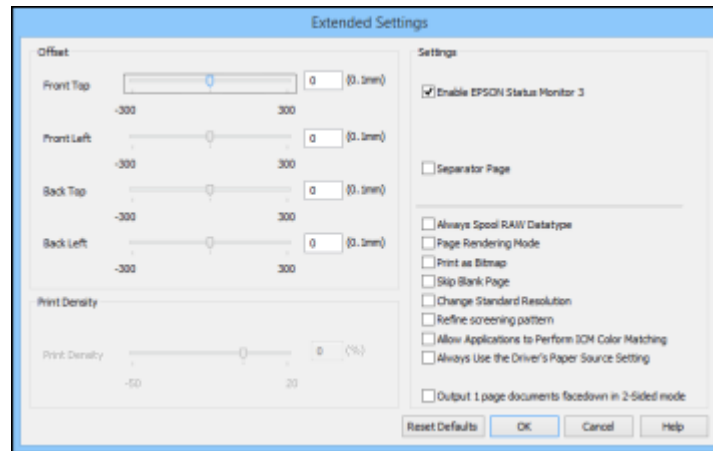

5. Select any of the extended settings to customize your print.
6. Click **OK** to close the Extended Settings window.
7. Click **OK** to close the printer software window.

[Extended Settings - Windows](#)

Parent topic: [Printing with Windows](#)

Extended Settings - Windows

You can select from these settings on the Extended Settings window.

Enable EPSON Status Monitor 3

Enables product monitoring for ink and paper supplies and other issues.

Separator Page

Before each document, prints a separator page containing the title, user, date, and time.

Always Spool RAW Datatype

Increases print speed and may solve other printing problems.

Page Rendering Mode

Increases print speed when printing is extremely slow or the print head stops during printing.

Print as Bitmap

Increases print speed when printing is extremely slow or the print head stops during printing, and other settings do not help.

Skip Blank Page

Ensures that your product does not print pages that contain no text or images.

Change Standard Resolution

Reduces the resolution of print data to correct printing problems.

Refine screening pattern

Prints graphics with a finer screening pattern.

Allow Applications to Perform ICM Color Matching

Allows applications to perform ICM color matching.

Always Use the Driver's Paper Source Setting

Prints using the paper source setting in the printer driver, rather than the setting in your application.

Output 1 page documents facedown in 2-Sided mode

Outputs single-sided pages in a 2-sided print job facedown instead of faceup.

Parent topic: [Selecting Extended Settings - Windows](#)

Printing Your Document or Photo - Windows

Once you have selected your print settings, you are ready to save your settings and print.

1. Click **OK** to save your settings.

You see your application's Print window, such as this one:



2. Click **OK** or **Print** to start printing.

[Checking Print Status - Windows](#)

Parent topic: [Printing with Windows](#)

Checking Print Status - Windows

During printing, you see this window showing the progress of your print job. It allows you to control printing and check ink status.



- To cancel printing, click **Cancel**.
- To see print jobs lined up for printing, click **Print Queue**.

Parent topic: [Printing Your Document or Photo - Windows](#)

Selecting Default Print Settings - Windows

When you change your print settings in a program, the changes apply only while you are printing in that program session. If you want to change the print settings you use in all your Windows programs, you can select new default print settings.

1. Access the Windows Desktop and right-click the product icon in the Windows taskbar.
2. Select **Printer Settings**.

You see the printer settings window:

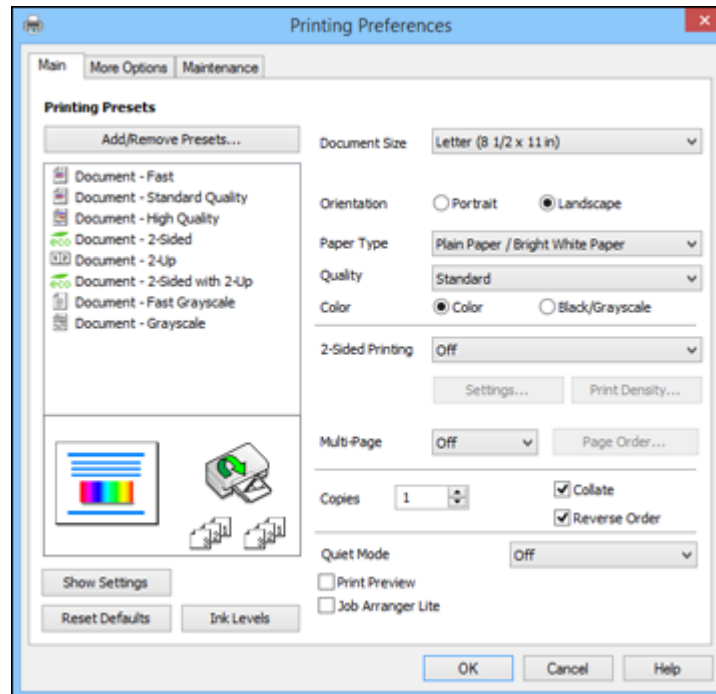

3. Select the print settings you want to use as defaults in all your Windows programs.
4. Click **OK**.

These settings are now the defaults selected for printing. You can still change them as needed for printing in any program session.

[Changing the Language of the Printer Software Screens](#)

Parent topic: [Printing with Windows](#)

Changing the Language of the Printer Software Screens

You can change the language used on the Windows printer software screens.

1. Access the Windows Desktop and right-click the product icon in the Windows taskbar.

2. Select **Printer Settings**.
You see the printer settings window.
3. Click the **Maintenance** tab.
You see the maintenance options:

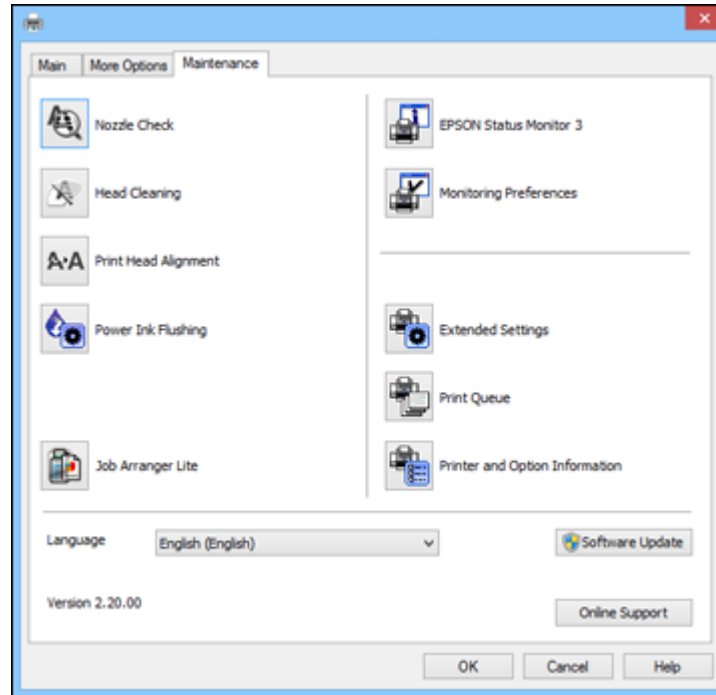

4. Select the language you want to use as the **Language** setting.
5. Click **OK** to close the printer software window.

The printer software screens appear in the language you selected the next time you access them.

Parent topic: [Selecting Default Print Settings - Windows](#)

Changing Automatic Update Options

Your printer software for Windows automatically checks for updates to the product software. You can change how often the software checks for updates or disable this feature.

1. Access the Windows Desktop and right-click the product icon in the Windows taskbar.
2. Select **Software Update Settings**.

You see this window:

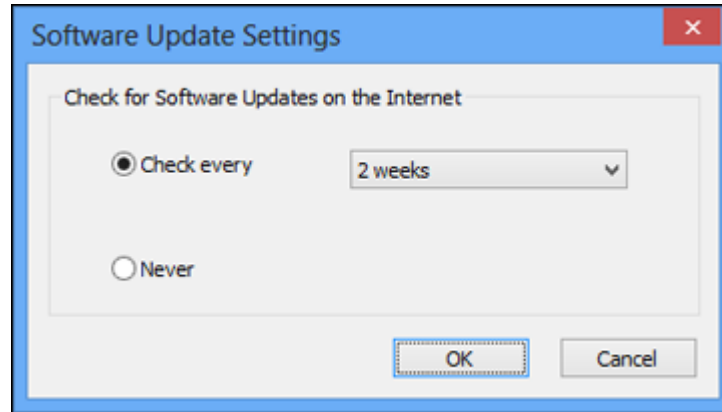

3. Do one of the following:
 - To change how often the software checks for updates, select a setting in the **Check every** menu.
 - To disable the automatic update feature, select the **Never** option.
4. Click **OK** to exit.

Note: If you choose to disable the automatic update feature, you can check for updates manually.

Parent topic: [Printing with Windows](#)

Printing with OS X

You can print with your product using any OS X printing program, as described in these sections.

Note: If you have an Internet connection, it is a good idea to check for updates to your product software on Epson's support website.

[Selecting Basic Print Settings - OS X](#)

[Selecting Page Setup Settings - OS X](#)

[Selecting Print Layout Options - OS X](#)

[Selecting Double-sided Printing Settings - OS X](#)

[Sizing Printed Images - OS X](#)

[Managing Color - OS X](#)

[Selecting Printing Preferences - OS X](#)

[Printing Your Document or Photo - OS X](#)

Parent topic: [Printing from a Computer](#)

Selecting Basic Print Settings - OS X

Select the basic settings for the document or photo you want to print.

1. Open a photo or document for printing.
2. Select the print command in your application.

Note: You may need to select a print icon on your screen, the **Print** option in the File menu, or another command. See your application's help utility for details.

3. Select your product as the **Printer** setting.

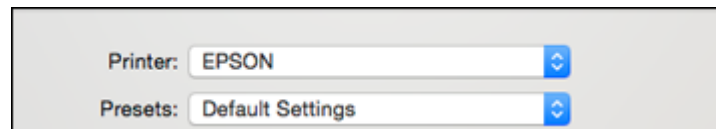

4. If necessary, click the arrow next to the Printer setting or the **Show Details** button to expand the print window.

You see the expanded printer settings window for your product:

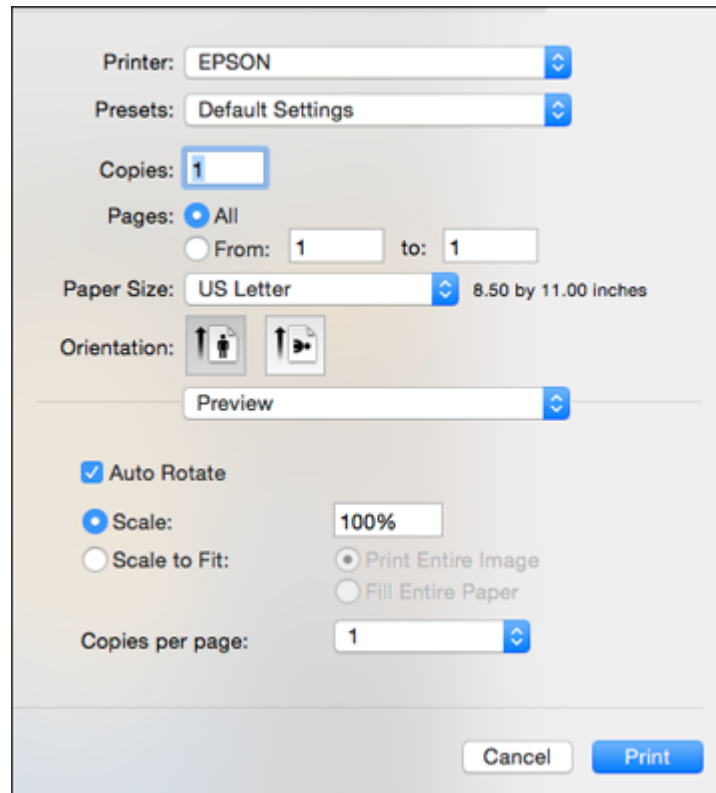

Note: The print window may look different, depending on the version of OS X and the application you are using.

5. Select the **Copies** and **Pages** settings as necessary.

Note: If you do not see these settings in the print window, check for them in your application before printing.

6. Select the page setup options: **Paper Size** and **Orientation**.

Note: If you do not see these settings in the print window, check for them in your application before printing. They may be accessible by selecting **Page Setup** from the File menu.

7. Select any application-specific settings that appear on the screen, such as those shown in the image above for the Preview application.
8. Select **Print Settings** from the pop-up menu.

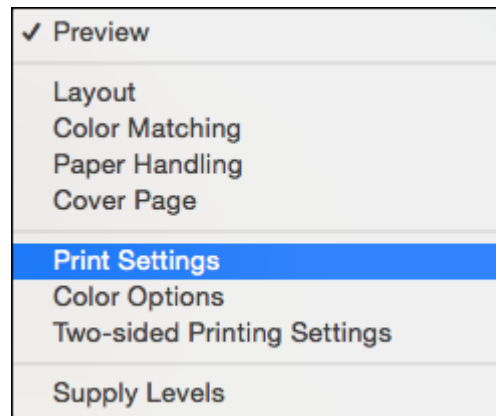

You see these settings:

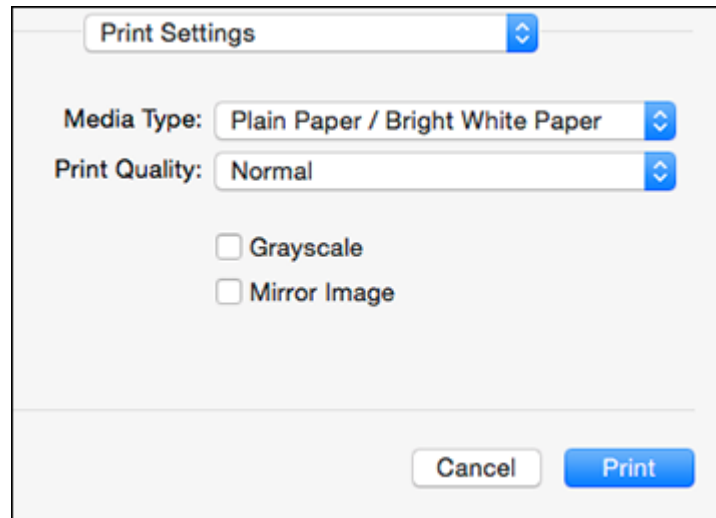

9. Select the type of paper you loaded as the **Media Type** setting.

Note: The setting may not exactly match the name of your paper. Check the paper type settings list for details.

10. Select the **Print Quality** setting you want to use.
11. Select any of the available print options.

[Print Quality Options - OS X](#)

[Print Options - OS X](#)

Parent topic: [Printing with OS X](#)

Related references

[Paper or Media Type Settings - Product Software](#)

Related tasks

[Selecting Page Setup Settings - OS X](#)

[Printing Your Document or Photo - OS X](#)

Print Quality Options - OS X

You can select any of the available Print Quality options to fine-tune the quality of your print. Some settings may be unavailable, depending on the paper type setting you have chosen.

Draft

For draft printing on plain paper.

Normal

For everyday text and image printing.

Normal - Vivid

For everyday text and image printing with good quality and print speed.

Fine

For text and graphics with good quality and print speed.

Quality

For text and graphics with increased quality and print speed.

Parent topic: [Selecting Basic Print Settings - OS X](#)

Print Options - OS X

You can select any of the print options to customize your print. Some options may be unavailable, depending on other settings you have chosen.

Grayscale

Prints text and graphics in black or shades of gray.

Mirror Image

Lets you flip the printed image horizontally.

Parent topic: [Selecting Basic Print Settings - OS X](#)

Selecting Page Setup Settings - OS X

Depending on your application, you may be able to select the paper size and orientation settings from the print window.

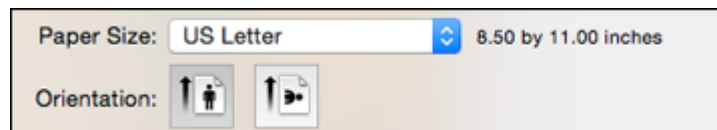

Note: If you do not see these settings in the print window, check for them in your application before printing. They may be accessible by selecting **Page Setup** from the File menu.

1. Select the size of the paper you loaded as the **Paper Size** setting.
2. Select the orientation of your document or photo as shown in the print window.

Note: If you are printing an envelope, select the  icon.

Note: You can reduce or enlarge the size of the printed image by selecting **Paper Handling** from the pop-up menu and selecting a scaling option.

Parent topic: [Printing with OS X](#)

Selecting Print Layout Options - OS X

You can select a variety of layout options for your document or photo by selecting **Layout** from the pop-up menu on the print window.

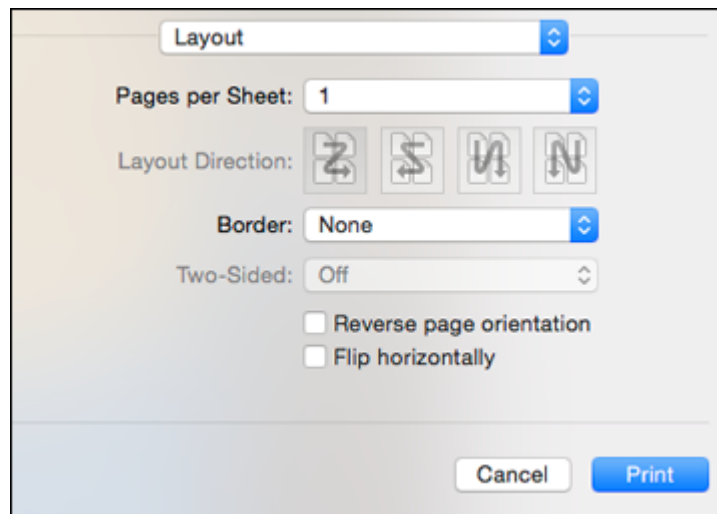

- To print multiple pages on one sheet of paper, select the number of pages in the **Pages per Sheet** pop-up menu. To arrange the print order of the pages, select a **Layout Direction** setting.
- To print borders around each page on the sheet, select a line setting from the **Border** pop-up menu.

- To invert or flip the printed image, select the **Reverse page orientation** or **Flip horizontally** settings.

Parent topic: [Printing with OS X](#)

Selecting Double-sided Printing Settings - OS X

You can print on both sides of the paper by selecting **Two-sided Printing Settings** from the pop-up menu on the print window.

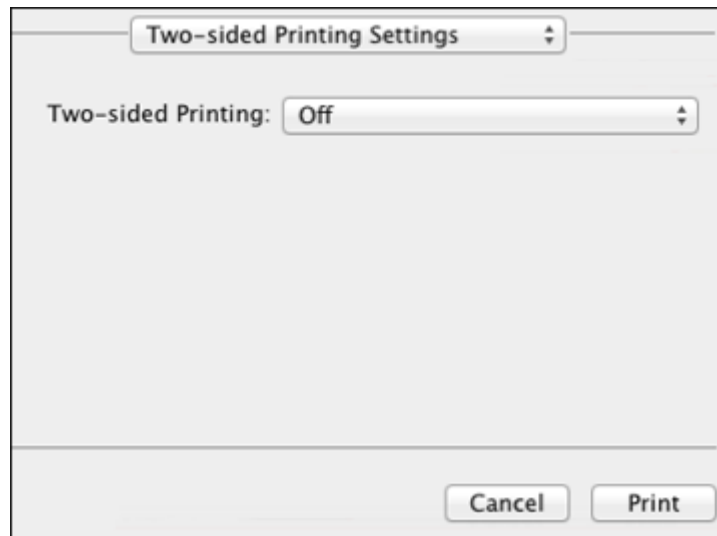

Note: Some options may be pre-selected or unavailable, depending on other settings you have chosen or if you are accessing the product over a network. This screen may be different, depending on the version of OS X you are using.

1. Select one of the **Two-sided Printing** options.

2. Select the type of document you are printing as the **Document Type** setting. The software automatically sets the Adjustments options for that document type.

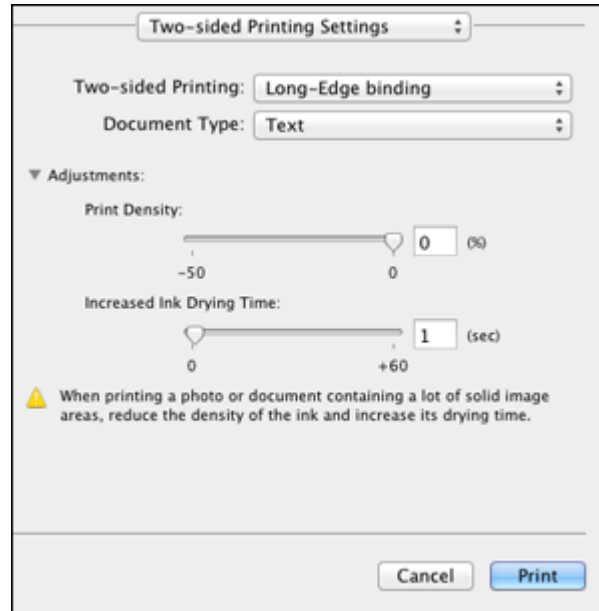

3. If necessary, customize the Adjustments settings as instructed on the screen.
4. Print a test copy of your double-sided document to test the selected settings.
5. Follow any instructions displayed on the screen during printing.

[Double-sided Printing Options and Adjustments - OS X](#)

Parent topic: [Printing with OS X](#)

Double-sided Printing Options and Adjustments - OS X

You can select any of the available options in the **Two-sided Printing Settings** or **Output Settings** pop-up menu to set up your double-sided print job.

Two-sided Printing Options

Long-Edge binding

Orients double-sided printed pages to be bound on the long edge of the paper.

Short-Edge binding

Orients double-sided printed pages to be bound on the short edge of the paper.

Adjustments

Print Density

Sets the level of ink coverage for double-sided printing.

Increased Ink Drying Time

Sets the amount of time required for drying ink after printing on one side of the paper before printing the other side in double-sided printing.

Parent topic: [Selecting Double-sided Printing Settings - OS X](#)

Sizing Printed Images - OS X

You can adjust print order and the size of the image as you print it by selecting **Paper Handling** from the pop-up menu on the Print window.

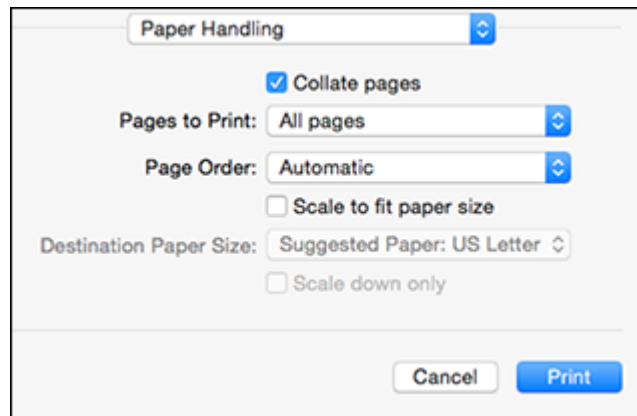

- To print only selected pages in a multi-page document, select an option from the **Pages to Print** pop-up menu.
- To adjust the order in which pages are printed, select an option from the **Page Order** pop-up menu.
- To scale the image to fit on a specific paper size, select the **Scale to fit paper size** checkbox and select a paper size from the **Destination Paper Size** pop-up menu.

Parent topic: [Printing with OS X](#)

Managing Color - OS X

You can adjust the Color Matching and Color Options settings to fine-tune the colors in your printout, or turn off color management in your printer software.

1. Select **Color Matching** from the pop-up menu in the print window.

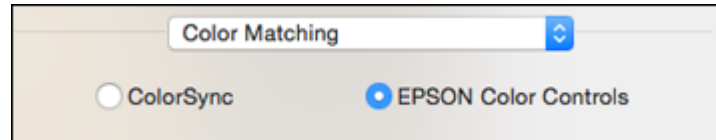

2. Select one of the available options.
3. Select **Color Options** from the pop-up menu in the print window.

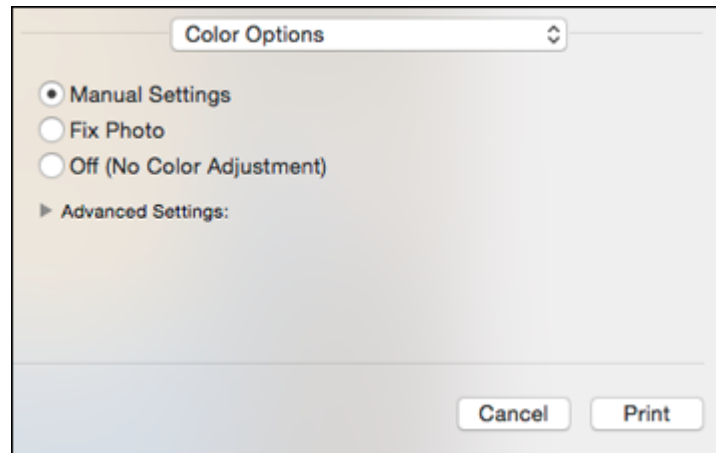

Note: The available settings on the Color Options menu depend on the option you selected on the Color Matching menu.

4. Select one of the available options.

[Color Matching and Color Options - OS X](#)

Parent topic: [Printing with OS X](#)

Color Matching and Color Options - OS X

You can select from these settings on the **Color Matching** and **Color Options** menus.

Color Matching Settings

EPSON Color Controls

Lets you manage color using controls in your printer software or turn off color management.

ColorSync

Prints using standard color profiles for your product and paper to help match image colors. You can customize the conversion method and filter settings on the ColorSync pop-up menu in the print window.

Color Options Settings

Manual Settings

Lets you select manual color adjustments. Click the arrow next to **Advanced Settings** and select settings for **Brightness**, **Contrast**, **Saturation**, and individual color tones. You can also select a color **Mode** setting for printing photos and graphics and the **Fix Red-Eye** setting to reduce or remove red-eye in photos. Depending on the selected color mode, you can also adjust the midtone density using the **Gamma** setting.

Fix Photo

Improves the color, contrast, and sharpness of flawed photos. Click the arrow next to **Advanced Settings** and select the **Fix Red-Eye** setting to reduce or remove red-eye in photos.

Note: Fix Photo uses a sophisticated face recognition technology to optimize photos that include faces. For this to work, both eyes and the nose must be visible in the subject's face. If your photo includes a face with an intentional color cast, such as a statue, you may want to turn off **Fix Photo** to retain the special color effects.

Off (No Color Adjustment)

Turns off color management in your printer software so you can manage color using only your application software.

Note: An ICC profile is required if color management is turned off.

Parent topic: [Managing Color - OS X](#)

Selecting Printing Preferences - OS X

You can select printing preferences that apply to all the print jobs you send to your product.

1. In the Apple menu or the Dock, select **System Preferences**.
2. Select **Print & Fax**, **Print & Scan**, or **Printers & Scanners**, select your product, and select **Options & Supplies**.
3. Select **Driver** or **Options**.

You see a screen like this:

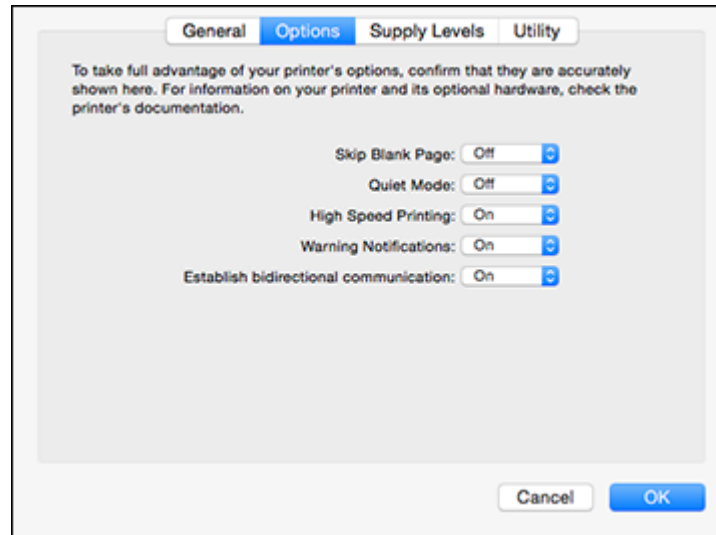

4. Select any of the available printing preferences.
5. Click **OK**.

[Printing Preferences - OS X](#)

Parent topic: [Printing with OS X](#)

Printing Preferences - OS X

You can select from these settings on the **Options** or **Driver** tab.

Skip Blank Page

Ensures that your product does not print pages that contain no text or images.

Quiet Mode

Lessens noise during printing when you select **Plain Paper/Bright White Paper** as the paper Type or Media Type setting.

High Speed Printing

Speeds up printing but may reduce print quality.

Warning Notifications

Lets you choose whether or not to receive warning notifications from the printer software for various operating conditions.

Establish bidirectional communication

Allows the product to communicate with the computer. Do not change the default setting unless you experience issues when using a shared printing pool.

Parent topic: [Selecting Printing Preferences - OS X](#)

Printing Your Document or Photo - OS X

Once you have selected your print settings, you are ready to print.

Click **Print** at the bottom of the print window.

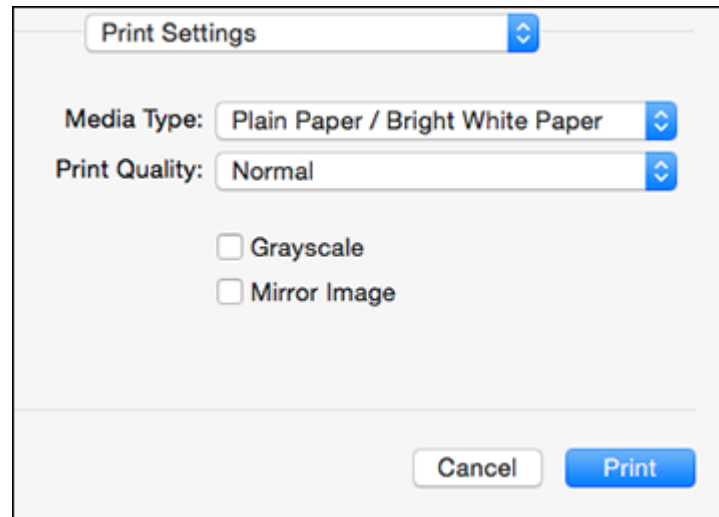

[Checking Print Status - OS X](#)

Parent topic: [Printing with OS X](#)

Related tasks

[Selecting Basic Print Settings - OS X](#)

[Selecting Page Setup Settings - OS X](#)

[Selecting Print Layout Options - OS X](#)

[Selecting Double-sided Printing Settings - OS X](#)

[Managing Color - OS X](#)

[Selecting Printing Preferences - OS X](#)

Checking Print Status - OS X



During printing, you can view the progress of your print job and control printing.

1. Click the printer icon when it appears in the Dock.

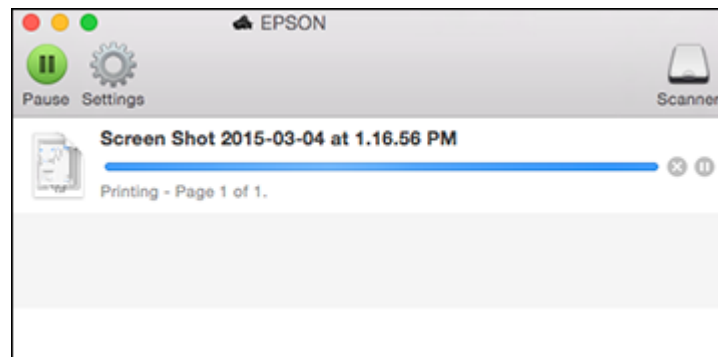
You see the print status window:



2. Select the following options as necessary:

- To cancel printing, click the print job and click  or **Delete**.
- To pause a print job, click the print job and click  or **Hold**. To resume a print job, click the paused print job and click  or **Resume**.
- To pause printing for all queued print jobs, click **Pause** or **Pause Printer**.
- To display other printer information, click **Settings**.

Parent topic: [Printing Your Document or Photo - OS X](#)

Cancelling Printing Using a Product Button

If you need to cancel printing, press the  **Stop/Reset** button on your product.

Parent topic: [Printing from a Computer](#)

Scanning

You can scan original documents or photos and save them as digital files.

[Starting a Scan](#)

[Selecting Epson Scan Settings](#)

[Scanning with OS X Using Image Capture](#)

[Scanning Special Projects](#)

Starting a Scan

After placing your original documents or photos on your product for scanning, start scanning using one of these methods.

[Starting a Scan Using the Product Control Panel](#)

[Starting a Scan Using the Epson Scan Icon](#)

[Starting a Scan from a Scanning Program](#)

Parent topic: [Scanning](#)

Related topics

[Placing Originals on the Product](#)

Starting a Scan Using the Product Control Panel

You can scan an image using your product's control panel buttons.

Your product automatically selects suitable default scan settings, but you can view or change them as necessary.

1. Make sure you installed the product software and connected the product to your computer or network.

Note: Restart your computer after installing the product software to enable scanning from the control panel. Also make sure the Event Manager program is not being blocked by your firewall or security software.

2. Press the up or down arrow button, select **Scan**, and press the **OK** button.

The scan options are displayed:

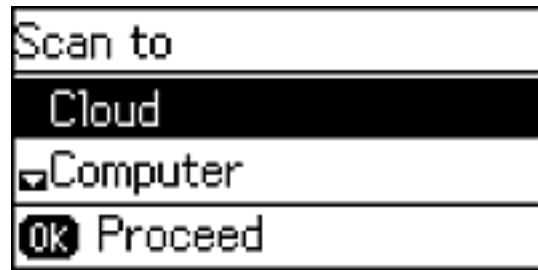

3. Press the up or down arrow button to select a scan option and press the **OK** button.
 - **Cloud** sends your scanned files to a destination that you have registered with Epson Connect.
 - **Computer** saves your scan as a JPEG file to your computer or as an image capture in OS X.
 - **Computer (WSD)** lets you manage network scanning in Windows 8.x, Windows 7, or Windows Vista (English only).

Note: To use this feature, you must first set up WSD (Web Services for Devices) on the Windows 7 or Windows Vista computer you want to scan to.

4. To scan to your computer, you first need to select how you connected your product to your computer:
 - If your product is connected directly to your computer with a USB cable, press the up or down arrow button to select **USB Connection**.
 - If your product is connected to your computer over a network, press the up or down arrow button to select the computer name from the list and press the **OK** button to begin scanning.
5. Press one of the **Start** buttons to start scanning.

[Changing Default Scan Button Settings](#)

Parent topic: [Starting a Scan](#)

Related tasks

[Using Epson Scan to Cloud](#)

Changing Default Scan Button Settings

You can view or change the default scan settings your product uses when you scan to your computer using the product buttons. You do this using the Event Manager program.

1. Do one of the following to open Event Manager:
 - **Windows 8.x:** Navigate to the **Apps** screen and select **Event Manager**.
 - **Windows (other versions):** Click  or **Start > All Programs** or **Programs > EPSON Software > Event Manager**.
 - **OS X:** Open the **Applications** folder, click **Epson Software**, and click **Event Manager**.
2. Open the **Scanner** (Windows) or **Select Scanner** (OS X) drop-down list and select your product, if necessary.
3. Click **Make Job Settings**.
4. Open the **Edit Job Settings** drop-down list and select the scan button settings you want to view or change.
5. Change the settings as necessary.
6. Click **OK**.
7. Click **Close** to close the Event Manager window.

Parent topic: [Starting a Scan Using the Product Control Panel](#)

Starting a Scan Using the Epson Scan Icon

You can start the Epson Scan program to select scan settings, scan, and save the scanned image to a file.

- **Windows 8.x:** Navigate to the **Apps** screen and select **EPSON Scan** under **EPSON** or **EPSON Software**.
- **Windows (other versions):** Click  or **Start**, and select **All Programs** or **Programs**. Select **EPSON** or **EPSON Software** and click **EPSON Scan**.
- **OS X:** Open the **Applications** folder, open the **Epson Software** folder, and double-click the **EPSON Scan** icon.

Note: With OS X, in addition to scanning with Image Capture, you can download and install Epson Scan scanning software. Epson Scan provides additional image adjustment and photo correction features for enhancing scanned images, and provides an interface for TWAIN-compliant OCR scanning software. To download Epson Scan, visit Epson's driver download site ([U.S. downloads](#) or [Canadian downloads](#)).

You see an Epson Scan window like this:

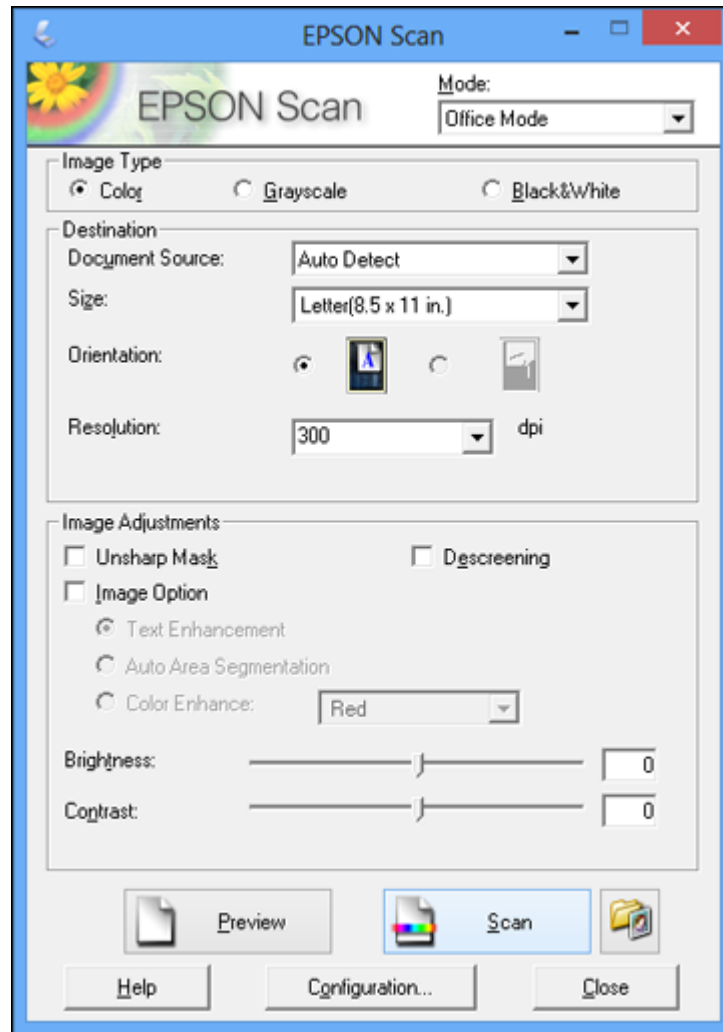

Parent topic: [Starting a Scan](#)

Related tasks

[Scanning with OS X Using Image Capture](#)

Related topics

[Selecting Epson Scan Settings](#)

Starting a Scan from a Scanning Program

You can start Epson Scan from a scanning program to select scan settings, scan, and open the scanned image in the program.

Note: With OS X, in addition to scanning with Image Capture, you can download and install Epson Scan scanning software. Epson Scan provides additional image adjustment and photo correction features for enhancing scanned images, and provides an interface for TWAIN-compliant OCR scanning software. To download Epson Scan, visit Epson's driver download site ([U.S. downloads](#) or [Canadian downloads](#)).

1. Open your scanning program and select its scanning option. (See your scanning program help for instructions.)
2. Select your product.

Note: In certain programs, you may need to select your product as the "source" first. If you see a **Select Source** option, choose it and select your product. With Windows, do not select a **WIA** option for your product; it will not work correctly.

You see an Epson Scan window like this:

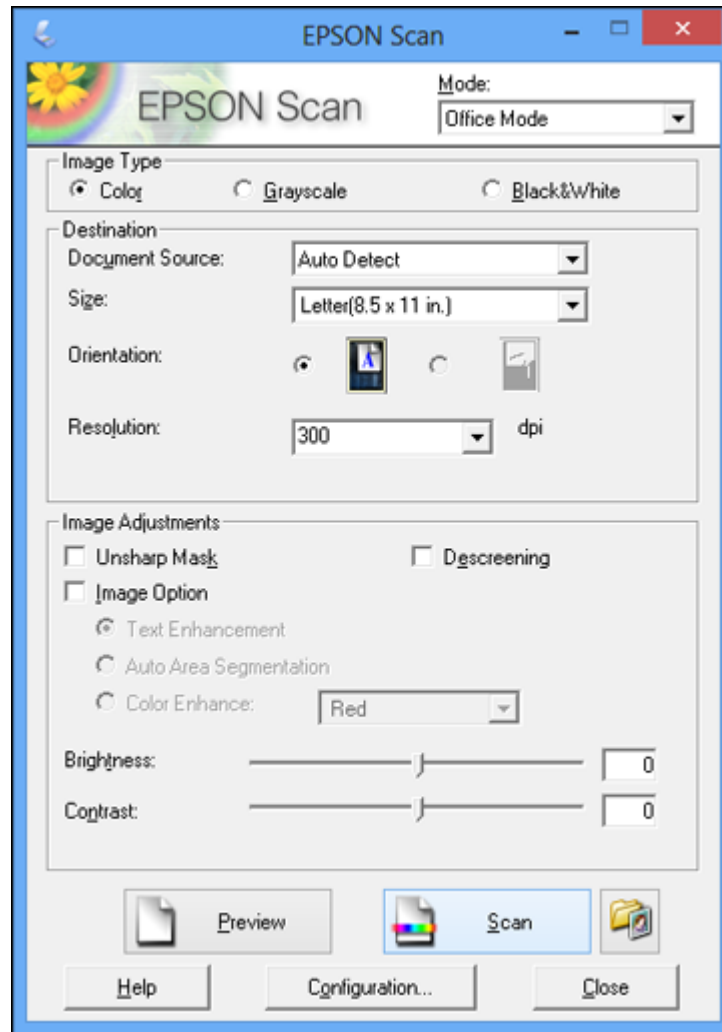

Note: Epson Scan may start in a different mode when you first access it.

Parent topic: [Starting a Scan](#)

Selecting Epson Scan Settings

After starting Epson Scan, you can select settings in various modes to customize your scan.

[Scan Modes](#)

[Selecting the Scan Mode](#)

[Scanning in Office Mode](#)

[Scanning in Home Mode](#)

[Scanning in Professional Mode](#)

[Image Preview Guidelines](#)

[Scan Resolution Guidelines](#)

[Selecting Scan File Settings](#)

Parent topic: [Scanning](#)

Scan Modes

Epson Scan provides a choice of scan modes with different levels of control over your settings.

Office Mode

You can quickly scan text documents and adjust them on a preview screen. You can also select various image adjustment options and preview your scanned image.

Home Mode

You can select setting groups based on the type of content you are scanning. You can also select various image adjustment options, and preview and size your scanned image.

Professional Mode

You can manually customize all available settings, and preview and size your scanned image.

Note: You must place your original on the scanner glass when using **Home Mode**.

Parent topic: [Selecting Epson Scan Settings](#)

Related tasks

[Selecting the Scan Mode](#)

Selecting the Scan Mode

Select the Epson Scan mode you want to use from the Mode box in the upper right corner of the Epson Scan window:

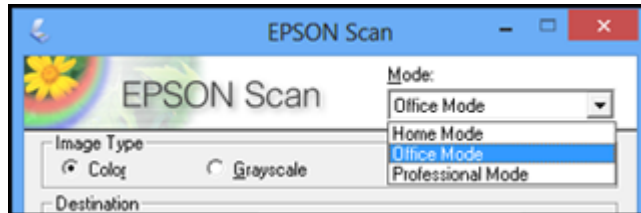

Parent topic: [Selecting Epson Scan Settings](#)

Related tasks

[Scanning in Office Mode](#)

[Scanning in Home Mode](#)

[Scanning in Professional Mode](#)

Scanning in Office Mode

When you scan in Office Mode, Epson Scan automatically saves your scanned file in JPEG format in your operating system's Pictures or My Pictures folder, or opens it in your scanning program. You can select settings, preview, and change the scanned file settings as necessary.

1. Start Epson Scan and select **Office Mode** as the Mode setting.

You see this window:

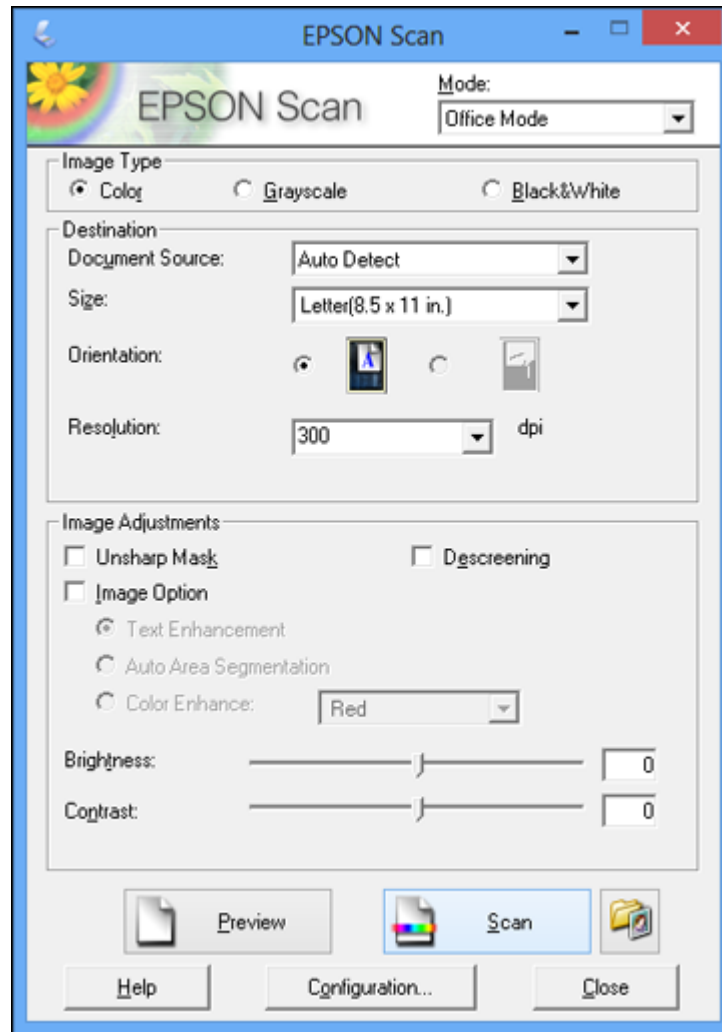

2. Select the **Image Type** setting that matches your original.
3. Select the **Document Source** setting indicating where you placed your original.

Note: If you are using the ADF, remove any documents from the scanner glass.

4. Select the **Size** and **Orientation** settings that match your original.
5. Select the **Resolution** setting you want to use for your scan.
6. Click the **Preview** button.

Note: If you are using the ADF, you can only preview one page at a time.

Epson Scan previews your original and displays the result in a separate Preview window.

7. If you are using the ADF, reinsert your original into the ADF.
8. If desired, select the area in your preview image that you want to scan (scan area).
9. Select any of the image adjustment settings you want to use. Before making adjustments, click the image or scan area in the Preview window.
10. Click **Scan**.

You see the File Save Settings window.

11. Change any of the necessary file save settings and click **OK**.

Epson Scan scans your original, and saves the file in the selected folder or opens it in your scanning program. If the file was saved directly to your computer, you see the file in the Windows Explorer or OS X Finder, where you can view and print the image, if desired.

[Available Document Source Settings - Office Mode](#)

[Selecting a Scan Area - Office Mode](#)

[Available Image Adjustments - Office Mode](#)

Parent topic: [Selecting Epson Scan Settings](#)

Related concepts

[Image Preview Guidelines](#)

[Scan Resolution Guidelines](#)

Related tasks

[Selecting Scan File Settings](#)

Available Document Source Settings - Office Mode

You can select these Document Source options in Epson Scan Office Mode.

Auto Detect

Automatically detects where the originals are placed on your product for scanning.

ADF

Selects the Automatic Document Feeder as the location where the originals are placed on your product for scanning.

Scanner Glass

Selects the scanner glass as the location where the originals are placed on your product for scanning.

Parent topic: [Scanning in Office Mode](#)

Selecting a Scan Area - Office Mode

You can select a specific area in your preview image to include in your scanned image. You can select the entire image area or a portion of it. You can even select multiple scan areas to create multiple scanned images of different areas.

You can also use the scan area to select specific Image Adjustments settings for a scanned image. Just be sure to click inside the scan area before selecting the settings.

1. In the Preview window, click the  Auto Locate icon to create a marquee (dotted line) on the preview image.

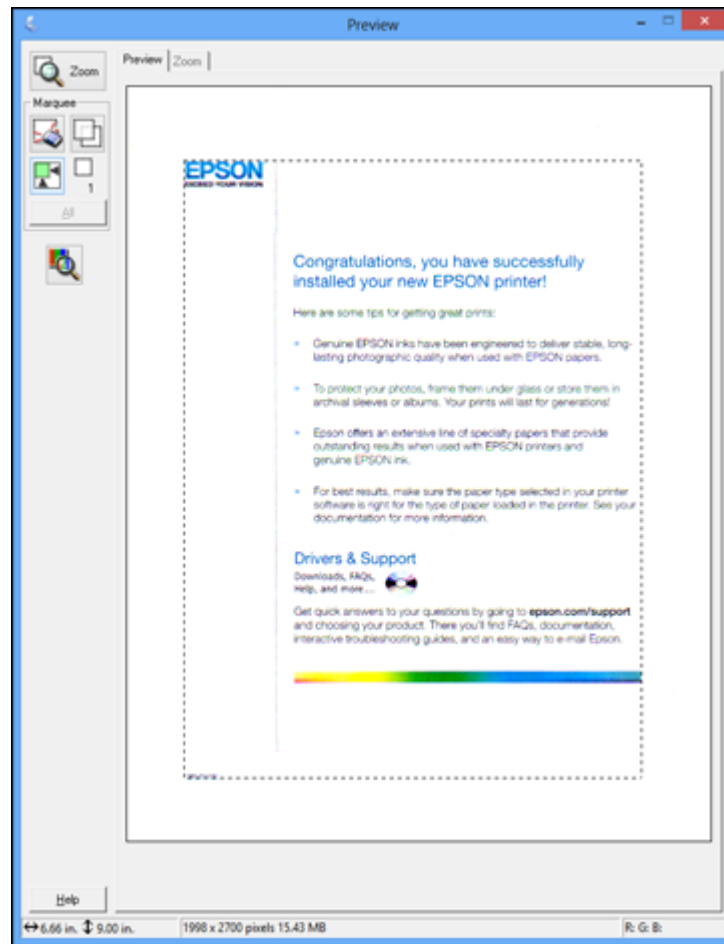

2. Do the following, as necessary, to work with the selected scan area:
 - If the marquee is correct, continue with the next step.
 - To move the marquee, click inside the scan area and drag the marquee where you want it.

- To resize the scan area, place your cursor over the edge or corner of the marquee, then click and drag the edges where you want them. (Hold down the **Shift** key as you resize the marquee to retain the same width/height proportions.)
- To create additional marquees (up to 50, if available), click the  Copy Marquee icon to copy the existing marquee and paste it on the preview image.

Note: If you draw multiple marquees, make sure you select the **All** button in the Preview window before you scan. Otherwise, only the area inside the currently selected marquee will be scanned.

- To delete a marquee, click the marquee, then click the  Delete Marquee icon.

3. Click inside each scan area and make any necessary settings in the Epson Scan window.

Parent topic: [Scanning in Office Mode](#)

Available Image Adjustments - Office Mode

You can select these Image Adjustments options in Epson Scan Office Mode. Not all adjustment settings may be available, depending on other settings you have chosen.

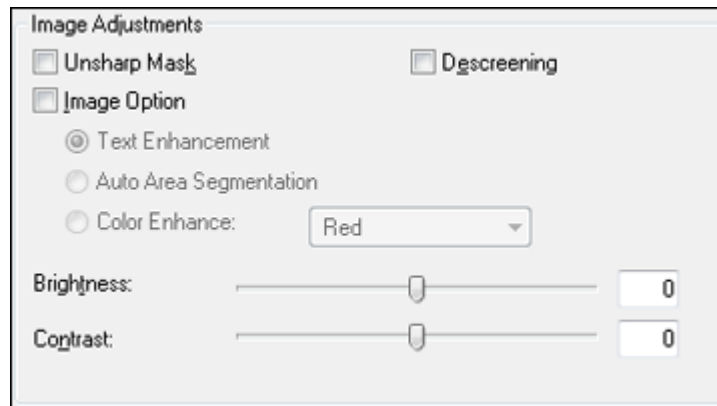

Note: Select the **Image Option** checkbox if you need to set any of the grayed-out image adjustments beneath the checkbox. Not all adjustment settings may be available, depending on the Image Type setting.

Unsharp Mask

Makes the edges of certain image areas clearer. Turn off this option to leave softer edges.

Descreening

Removes the ripple pattern that might appear in subtly shaded image areas, such as skin tones. This option improves results when scanning magazines or newspapers. (The results of descreening do not appear in the preview image, only in your scanned image.)

Text Enhancement

Sharpens the appearance of letters in text documents.

Auto Area Segmentation

Makes grayscale images clearer and text recognition more accurate by separating the text from the graphics.

Color Enhance

Enhances the red, green, or blue shades in the scanned image.

Brightness

Adjusts the overall lightness and darkness of the scanned image.

Contrast

Adjusts the difference between the light and dark areas of the overall scanned image.

Threshold

Adjusts the level at which black areas in text and line art are delineated, improving text recognition in OCR (Optical Character Recognition) programs.

Parent topic: [Scanning in Office Mode](#)

Scanning in Home Mode

When you scan in Home Mode, Epson Scan automatically saves your scanned file in JPEG format in your operating system's Pictures or My Pictures folder, or opens it in your scanning program. You can select settings, preview, and change the scanned file settings as necessary.

1. Start Epson Scan and select **Home Mode** as the Mode setting.

You see this window:

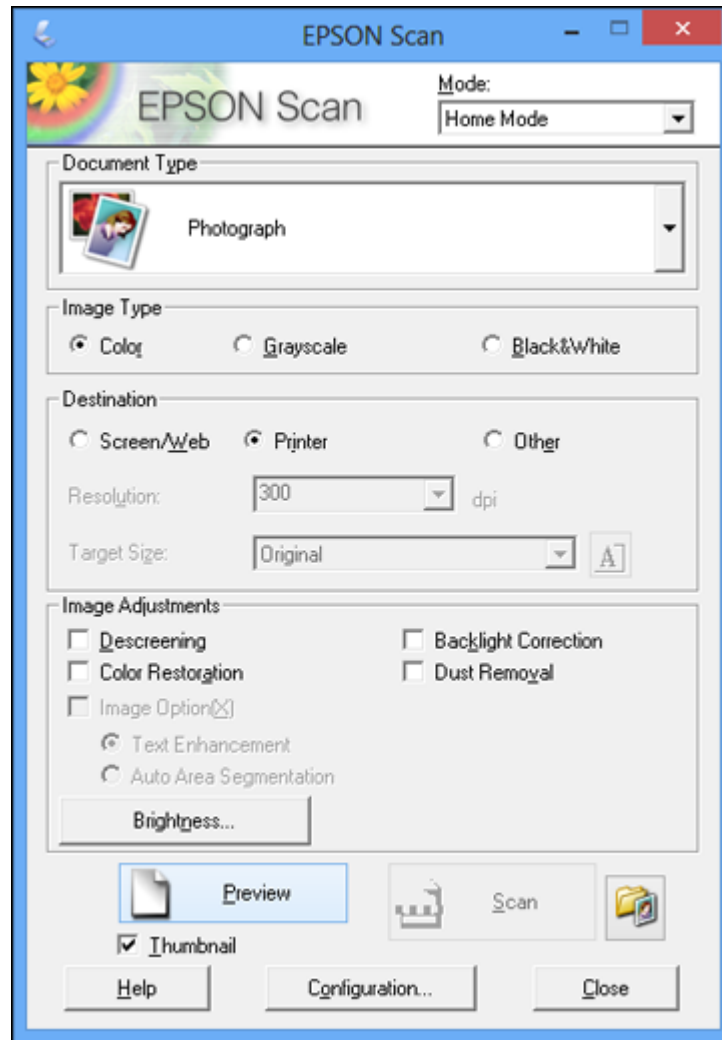

2. Select the **Document Type** setting that matches your original, such as **Photograph** or **Text/Line Art**.
3. Select the **Image Type** setting that matches your original.

4. Select the way you plan to use your scanned image as the **Destination** setting. (The Resolution setting is selected automatically based on the Destination setting you choose.)
 - **Screen/Web**: Select this option for images you will email, view on a computer screen, or post on the web.
 - **Printer**: Select this option for images you will print or documents you will convert to editable text using OCR (Optical Character Recognition) software.
 - **Other**: Select this option if you want to select a custom resolution for your image.
5. If you selected **Other** in the last step, select the **Resolution** setting you want to use for your scan.
6. Click the **Preview** button.

Epson Scan previews your original and displays the result in a separate Preview window.
7. If desired, select the area in your preview image that you want to scan (scan area).
8. Select any of the image adjustment settings you want to use. Before making adjustments, click the image or scan area in the Preview window.
9. If you want to reduce or enlarge your image as you scan, select the **Target Size** setting you want to use.
10. Click **Scan**.

You see the File Save Settings window.
11. Change any of the necessary file save settings and click **OK**.

Epson Scan scans your original, and saves the file in the selected folder or opens it in your scanning program. If the file was saved directly to your computer, you see the file in the Windows Explorer or OS X Finder, where you can view and print the image, if desired.

[Selecting a Scan Area - Home Mode](#)

[Available Image Adjustments - Home Mode](#)

[Selecting a Scan Size - Home Mode](#)

Parent topic: [Selecting Epson Scan Settings](#)

Related concepts

[Image Preview Guidelines](#)

[Scan Resolution Guidelines](#)

Related tasks

[Selecting Scan File Settings](#)

Selecting a Scan Area - Home Mode

You can select a specific area in your preview image to include in your scanned image. You can select the entire image area or a portion of it. You can even select multiple scan areas to create multiple scanned images of different areas (Normal Preview mode only).

You can also use the scan area to select specific Image Adjustments settings for a scanned image. Just be sure to click inside the scan area before selecting the settings.

1. Do one of the following to select your scan area in the Preview image:
 - **Thumbnail preview:** Your scan area is selected automatically, but you can change it. Place your cursor in one corner of the desired scan area, then click and drag the cursor to the opposite corner to create a marquee (dotted line) on the preview image.

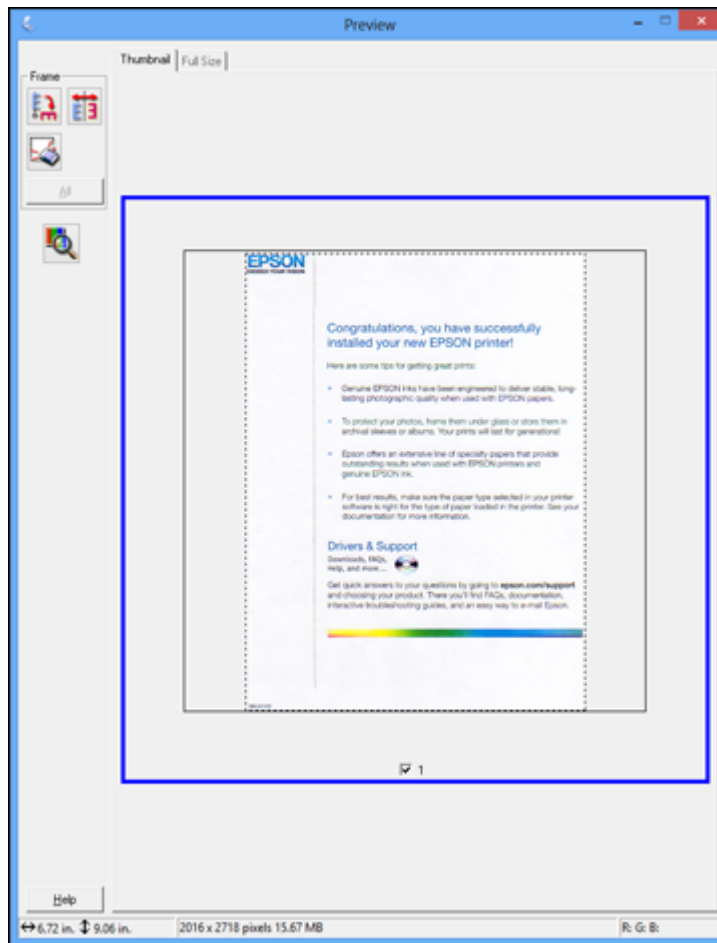

- **Normal preview:** Click the  Auto Locate icon to create a marquee (dotted line) on the preview image.

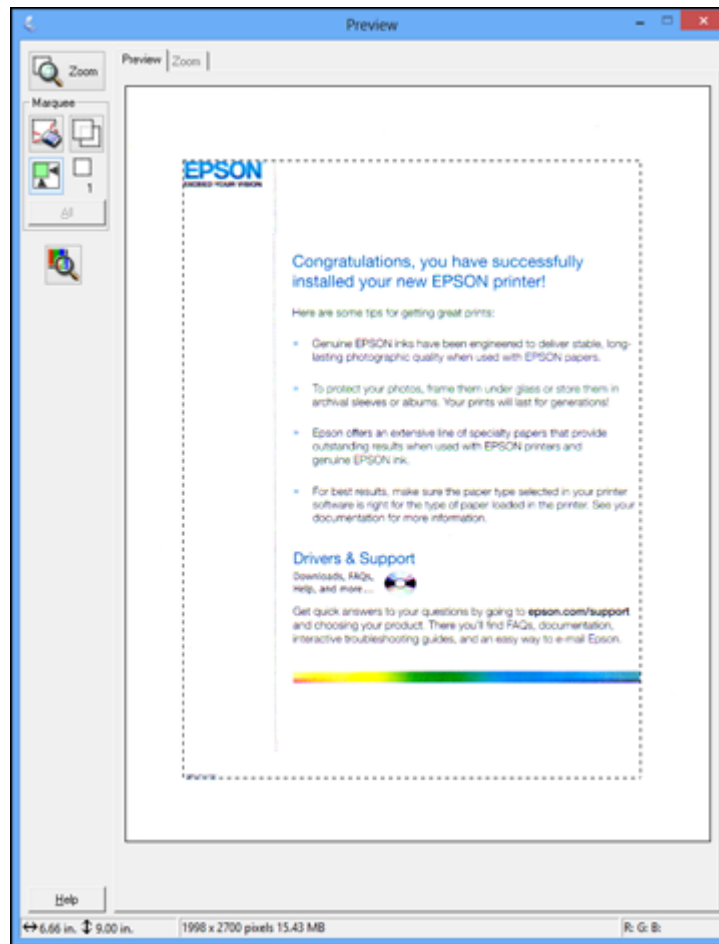

2. Do the following, as necessary, to work with the selected scan area:
 - If the marquee is correct, continue with the next step.
 - To move the marquee, click inside the scan area and drag the marquee where you want it.

- To resize the scan area, place your cursor over the edge or corner of the marquee, then click and drag the edges where you want them. (Hold down the **Shift** key as you resize the marquee to retain the same width/height proportions.)
- **Normal preview:** To create additional marquees (up to 50), click the  Copy Marquee icon to copy the existing marquee and paste it on the preview image.

Note: If you draw multiple marquees, make sure you select the **All** button in the Preview window before you scan. Otherwise, only the area inside the currently selected marquee will be scanned.

- To delete a marquee, click the marquee, then click the  Delete Marquee icon.

3. Click inside the scan area and make any necessary settings in the Epson Scan window.

Parent topic: [Scanning in Home Mode](#)

Available Image Adjustments - Home Mode

You can select these Image Adjustments options in Epson Scan Home Mode.

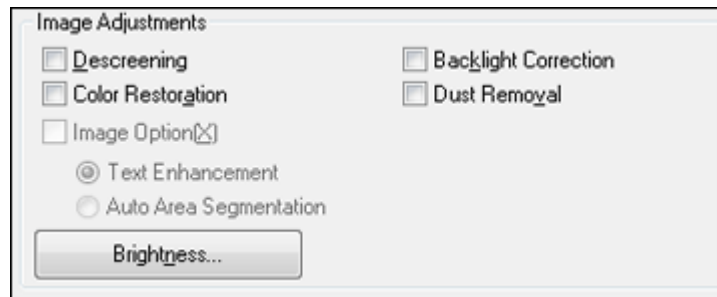

Note: Select the **Image Option** checkbox if you need to set any of the grayed-out image adjustments. Not all adjustment settings may be available, depending on the Document Type and Image Type setting. Click the **Brightness** button to access additional settings.

Descreening

Removes the ripple pattern that might appear in subtly shaded image areas, such as skin tones. This option improves results when scanning magazines or newspapers. (The results of descreening do not appear in the preview image, only in your scanned image.)

Color Restoration

Restores the colors in faded photos automatically.

Backlight Correction

Removes shadows from photos that have too much background light.

Dust Removal

Removes dust marks from your originals automatically.

Text Enhancement

Sharpens the appearance of letters in text documents.

Auto Area Segmentation

Makes grayscale images clearer and text recognition more accurate by separating the text from the graphics.

Brightness

Adjusts the overall lightness and darkness of the scanned image.

Contrast

Adjusts the difference between the light and dark areas of the overall scanned image.

Threshold

Adjusts the level at which black areas in text and line art are delineated, improving text recognition in OCR (Optical Character Recognition) programs.

Parent topic: [Scanning in Home Mode](#)

Selecting a Scan Size - Home Mode

You can reduce or enlarge the size of your image as you scan. You can also select a specific scan size, such as a common photo size like 4 × 6 inches (102 × 152 mm). This places a scan area of that size on the preview image so you can use it to help crop the image in the correct proportions.

1. Click the **Preview** button to preview your image.
2. In the Epson Scan window, select the size you want your scanned image to be from the **Target Size** list.

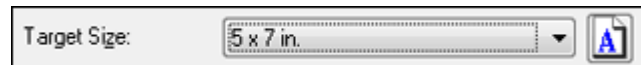

Note: If you need to rotate the orientation of the target size for your image, click the  Orientation icon.

A marquee (dotted line) appears on your preview image proportioned for the size you selected.

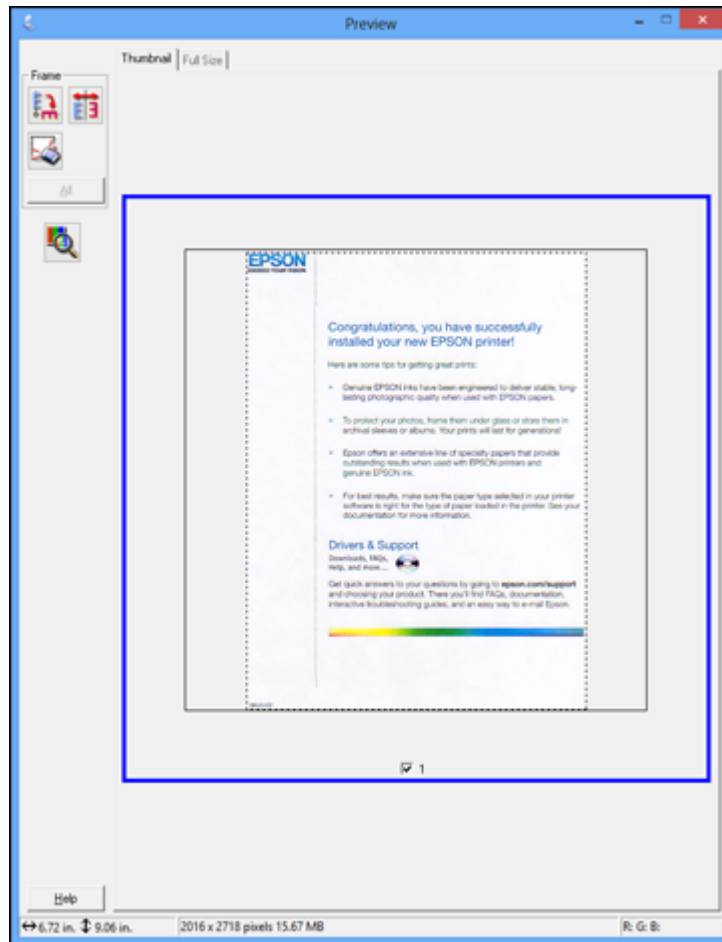

3. Do the following, as necessary, to work with the selected scan area:
 - To move the marquee, click inside the scan area and drag the marquee where you want it.

- To resize the scan area, place your cursor over the edge or corner of the marquee, then click and drag the edge where you want it.

Note: Manually adjusting the marquee will not change the target size of the scanned file. The marquee only indicates the area of the image that will be scanned.

4. To create a scanned image size that is not available in the Target Size list, click the **Customize** option.

You see this window:

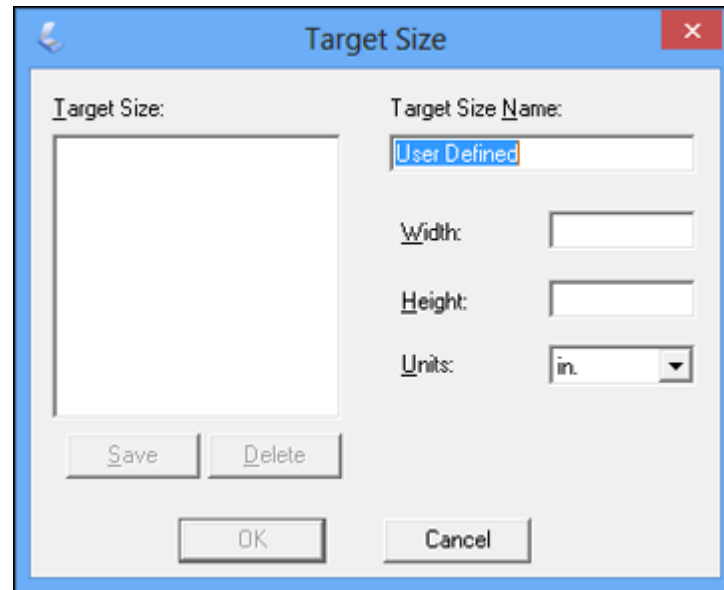

5. Name the custom size, enter the size, click **Save**, and click **OK**. Then adjust the marquee on the preview image.

The marquee is automatically proportioned for your custom scan size.

Parent topic: [Scanning in Home Mode](#)

Scanning in Professional Mode

When you scan in Professional Mode, Epson Scan automatically saves your scanned file in PDF format in your operating system's Documents or My Documents folder, or opens it in your scanning program. You can select settings, preview, and change the scanned file settings as necessary.

1. Start Epson Scan and select **Professional Mode** as the Mode setting.

You see this window:

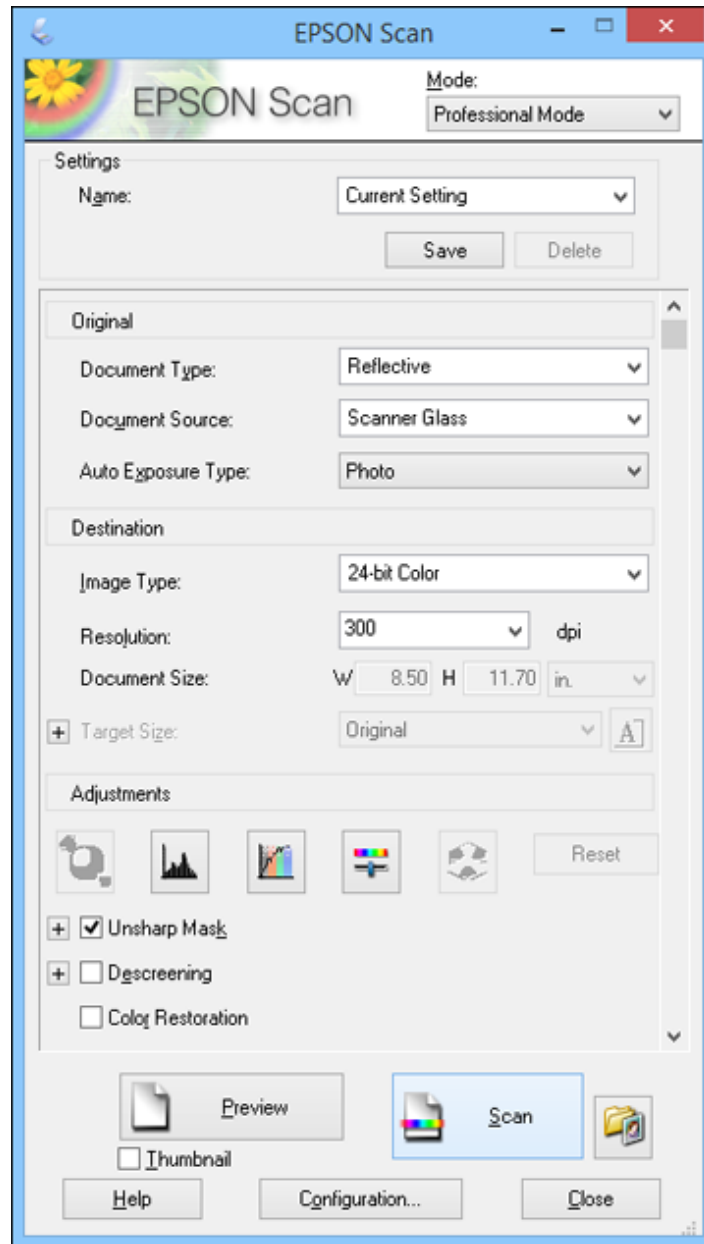

2. Select the **Document Type** setting that matches your original, such as **Reflective** for documents or photos.
3. Select the **Document Source** setting indicating where you placed your original.

Note: If you are using the ADF, remove any documents from the scanner glass.

4. Select the specific type of original you are scanning as the **Auto Exposure Type** setting: **Document** or **Photo**.
5. Select the details of your original and how you want it scanned as the **Image Type** setting.
6. Select the **Resolution** setting you want to use for your scan.
7. Click the **Preview** button.

Note: If you are using the ADF, you can only preview one page at a time.

Epson Scan previews your original and displays the result in a separate Preview window.

8. If you are using the ADF, reinsert your original into the ADF.
9. If desired, select the area in your preview image that you want to scan (scan area).
10. Select any of the image adjustment settings you want to use. Before making adjustments, click the image or scan area in the Preview window.
11. If you want to reduce or enlarge your image as you scan, select the **Target Size** setting you want to use.
12. Click **Scan**.

You see the File Save Settings window.

13. Change any of the necessary file save settings and click **OK**.

Epson Scan scans your original, and saves the file in the selected folder or opens it in your scanning program. If the file was saved directly to your computer, you see the file in the Windows Explorer or OS X Finder, where you can view and print the image, if desired.

[Available Document Source Settings - Professional Mode](#)

[Available Image Types - Professional Mode](#)

[Selecting a Scan Area - Professional Mode](#)

[Available Image Adjustments - Professional Mode](#)

[Selecting a Scan Size - Professional Mode](#)

Parent topic: [Selecting Epson Scan Settings](#)

Related concepts

[Image Preview Guidelines](#)

[Scan Resolution Guidelines](#)

Related tasks

[Selecting Scan File Settings](#)

Available Document Source Settings - Professional Mode

You can select these Document Source options in Epson Scan Professional Mode.

ADF

Selects the Automatic Document Feeder as the location where the originals are placed on your product for scanning.

Scanner Glass

Selects the scanner glass as the location where the originals are placed on your product for scanning.

Parent topic: [Scanning in Professional Mode](#)

Available Image Types - Professional Mode

You can select these Image Type options in Epson Scan Professional Mode.

24-bit Color

Select this setting for color photos.

Color Smoothing

Select this setting for color graphic images, such as charts or graphs.

8-bit Grayscale

Select this setting for black-and-white photos.

Black & White

Select this setting for black text documents or line art.

Parent topic: [Scanning in Professional Mode](#)

Selecting a Scan Area - Professional Mode

You can select a specific area in your preview image to include in your scanned image. You can select the entire image area or a portion of it. You can even select multiple scan areas to create multiple scanned images of different areas (Normal Preview mode only).

You can also use the scan area to select specific image Adjustments settings for a scanned image. Just be sure to click inside the scan area before selecting the settings.

Note: In Professional Mode, the default Preview mode is Normal Preview mode. To use Thumbnail Preview mode instead, select the **Thumbnail** checkbox beneath the Preview button (if available), then click the **Preview** button to preview your image.

1. Do one of the following to select your scan area in the Preview image:

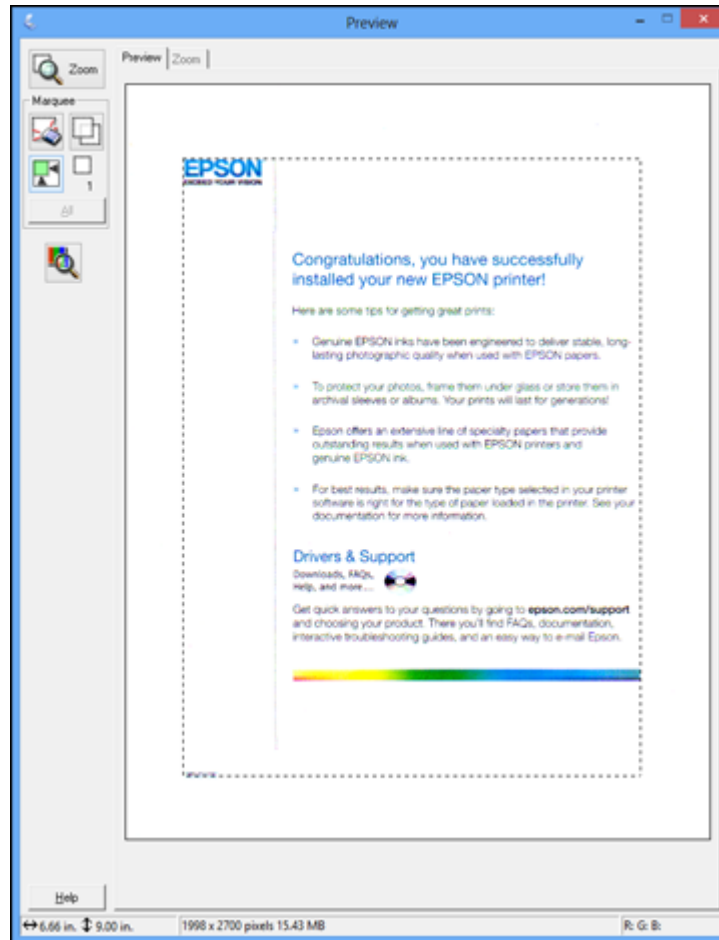

- **Normal preview:** Click the  Auto Locate icon to create a marquee (dotted line) on the preview image.

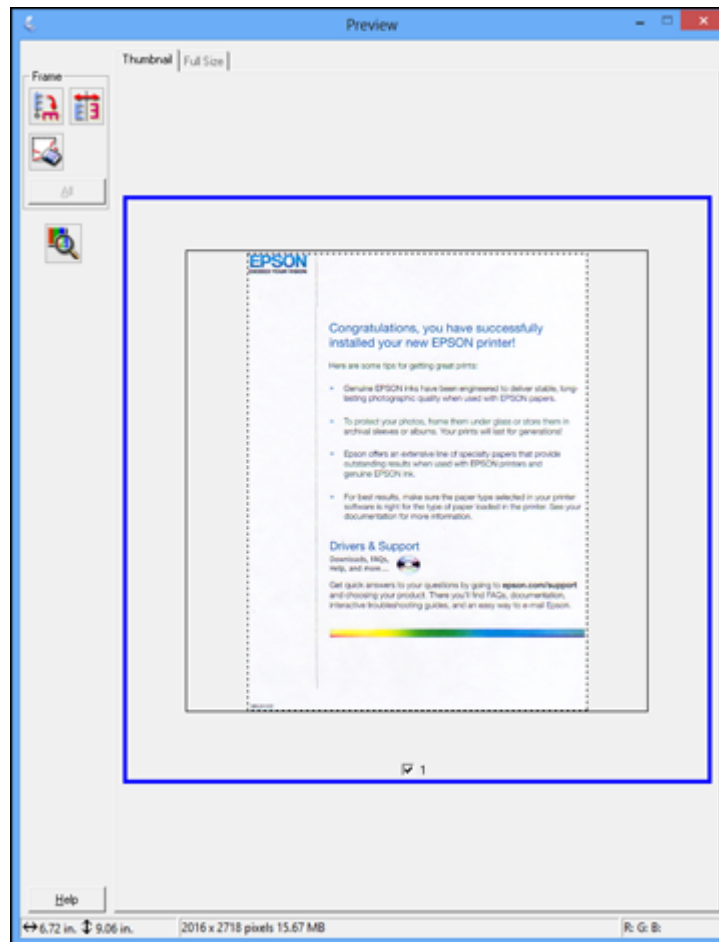

- **Thumbnail preview:** Your scan area is selected automatically, but you can change it. Place your cursor in one corner of the desired scan area, then click and drag the cursor to the opposite corner to create a marquee (dotted line) on the preview image.



2. Do the following, as necessary, to work with the selected scan area:
 - If the marquee is correct, continue with the next step.
 - To move the marquee, click inside the scan area and drag the marquee where you want it.

- To resize the scan area, place your cursor over the edge or corner of the marquee, then click and drag the edges where you want them. (Hold down the **Shift** key as you resize the marquee to retain the same width/height proportions.)
- **Normal preview:** To create additional marquees (up to 50, if available), click the  Copy Marquee icon to copy the existing marquee and paste it on the preview image.
- To delete a marquee, click the marquee, then click the  Delete Marquee icon.

Note: If you draw multiple marquees, make sure you select the **All** button in the Preview window before you scan. Otherwise, only the area inside the currently selected marquee will be scanned.

3. Click inside the scan area and make any necessary settings in the Epson Scan window.

Parent topic: [Scanning in Professional Mode](#)

Available Image Adjustments - Professional Mode

You can select these Adjustments options in Epson Scan Professional Mode. Not all adjustment settings may be available, depending on other settings you have chosen.

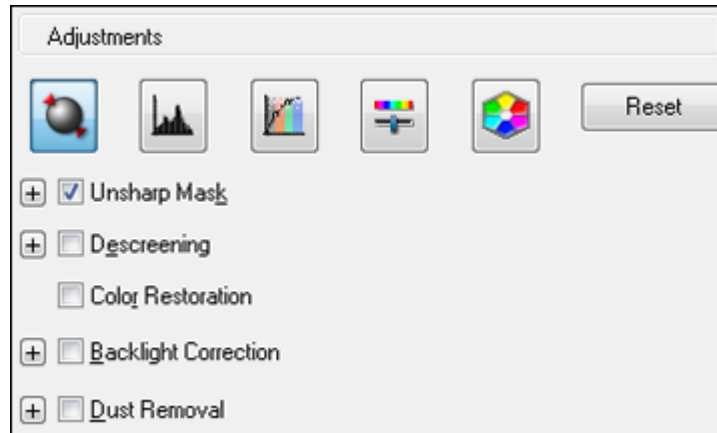

Click the  image adjustment icon to access additional settings.

Click the **+** (Windows) or **▶** (OS X) icon next to a setting to change the level of adjustment.

Unsharp Mask

Makes the edges of certain image areas clearer. Turn off this option to leave softer edges.

Descreening

Removes the ripple pattern that might appear in subtly shaded image areas, such as skin tones. This option improves results when scanning magazines or newspapers. (The results of descreening do not appear in the preview image, only in your scanned image.)

Color Restoration

Restores the colors in faded photos automatically.

Backlight Correction

Removes shadows from photos that have too much background light.

Dust Removal

Removes dust marks from your originals automatically.

Auto Exposure

Automatically adjusts the image exposure settings when you click the  Auto Exposure icon. To automatically adjust image exposure settings continuously, click the **Configuration** button, click the **Color** tab, and select **Continuous auto exposure**. You can adjust the level of auto exposure using a slider.

Histogram Adjustment

Provides a graphical interface for adjusting highlight, shadow, and gamma levels individually. (For advanced users only.) Click the  histogram icon to access the settings.

Tone Correction

Provides a graphical interface for adjusting tone levels individually. (For advanced users only.) Click the  tone correction icon to access the settings.

Brightness

Adjusts the overall lightness and darkness of the scanned image.

Contrast

Adjusts the difference between the light and dark areas of the overall scanned image.

Saturation

Adjusts the density of colors in the overall image.

Color Balance

Adjusts the balance of colors in the overall image.

Color Palette

Provides a graphical interface for adjusting mid-tone levels, such as skin tones, without affecting the highlight and shadow areas of the image. (For advanced users only.) Click the  Color Palette icon to access the settings.

Threshold

Adjusts the level at which black areas in text and line art are delineated, improving text recognition in OCR (Optical Character Recognition) programs.

Parent topic: [Scanning in Professional Mode](#)

Selecting a Scan Size - Professional Mode

You can reduce or enlarge the size of your image as you scan. You can also select a specific scan size, such as a common photo size like 4 × 6 inches (102 × 152 mm). This places a scan area of that size on the preview image so you can use it to help crop the image in the correct proportions.

1. Click the **Preview** button to preview your image.
2. In the Epson Scan window, select the size you want your scanned image to be from the **Target Size** list.

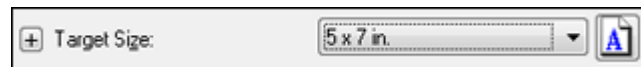

Note: If you need to rotate the orientation of the target size for your image, click the  orientation icon.

A marquee (dotted line) appears on your preview image proportioned for the size you selected.

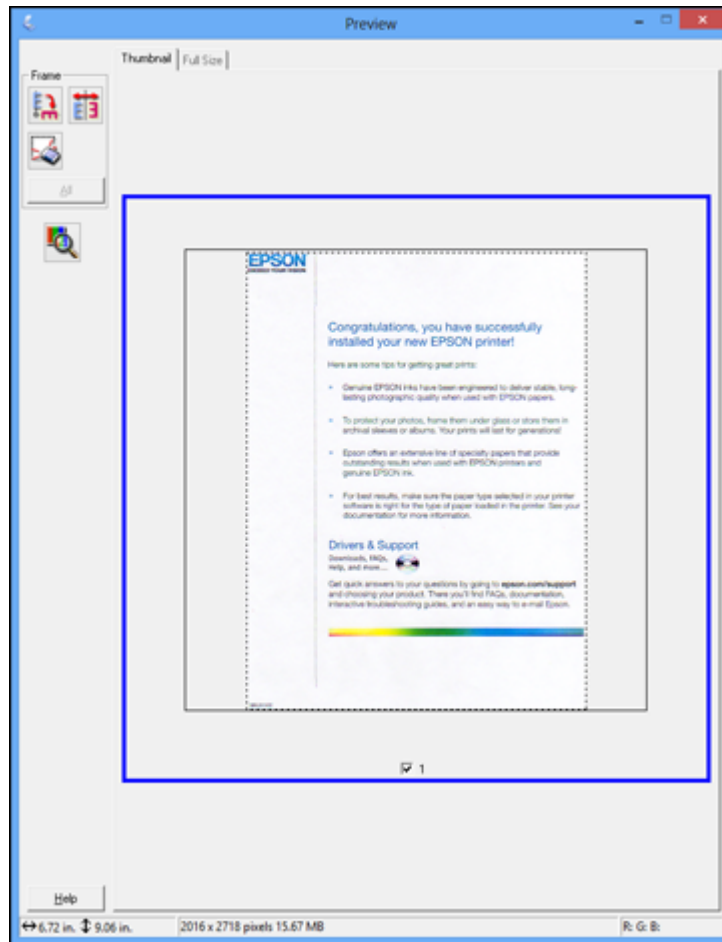

3. Do the following, as necessary, to work with the selected scan area:
 - To move the marquee, click inside the scan area and drag the marquee where you want it.

- To resize the scan area, place your cursor over the edge or corner of the marquee, then click and drag the edge where you want it.

Note: Manually adjusting the marquee will not change the target size of the scanned file. The marquee only indicates the area of the image that will be scanned.

4. To create a scanned image size that is not available in the Target Size list, click the **Customize** option.

You see this window:

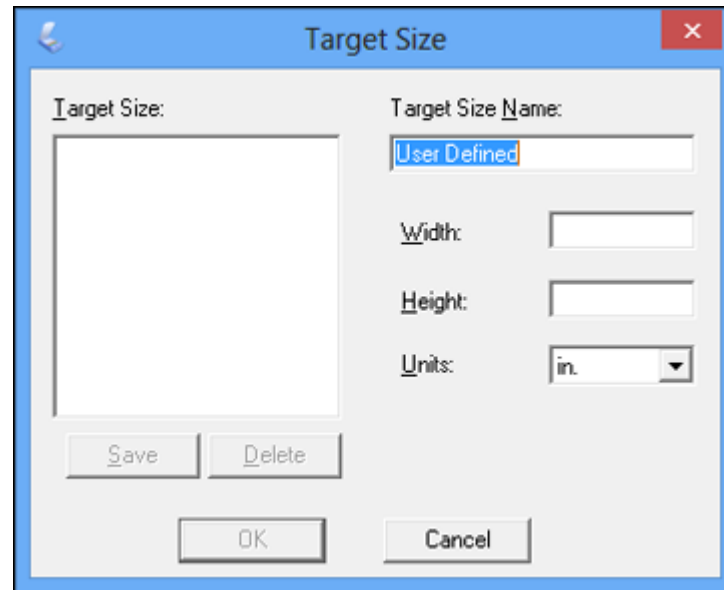

5. Name the custom size, enter the size, click **Save**, and click **OK**. Then adjust the marquee on the preview image.

The marquee is automatically proportioned for your custom scan size.

- To use additional sizing tools, click the + (Windows) or ► (OS X) icon next to the Target Size setting and select options as desired.

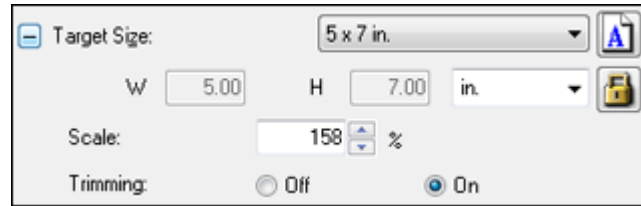

- **Scale:** Reduces or enlarges your image by the percentage you enter.
- **Trimming:** Turns automatic image cropping on or off.
-  **Unlock icon:** Unlocks the width/height proportions of the scanned image size so you can adjust it without constraint.

Parent topic: [Scanning in Professional Mode](#)

Image Preview Guidelines

You can preview your scanned image so you can adjust the scan settings using the preview as a guide. There are two types of preview available, depending on the scan mode and selected settings:

Thumbnail preview

A thumbnail preview displays your previewed images as thumbnails with the scanned image area and exposure automatically selected. If the **Thumbnail** checkbox is selected, clicking the **Preview** button opens a thumbnail preview.

Normal preview

A normal preview displays your previewed images in their entirety so you can select the scanned image area and other settings manually. If the **Thumbnail** checkbox is deselected, clicking the **Preview** button opens a normal preview.

Parent topic: [Selecting Epson Scan Settings](#)

Scan Resolution Guidelines

If you plan to enlarge a scanned image so you can print it at a larger size, you may need to increase the resolution from the default resolution set by Epson Scan. Follow these guidelines to determine the resolution setting you need:

- You will enlarge the image as you scan it.

If you will enlarge the image using Epson Scan's Target Size setting, you do not need to increase the Resolution setting.

- You will scan the image at its original size but enlarge it later in an image-editing program.

Increase Epson Scan's Resolution setting in your scan. Increase the resolution by the same amount you will increase the image size to retain a high image quality. For example, if the resolution is 300 dpi (dots per inch) and you will double the image size later, change the Resolution setting to 600 dpi.

- You will scan the image at 100% or smaller size.

Select Epson Scan's Resolution setting based on how you will use the scanned image:

- Email/view on a computer screen/post on the web: 96 to 150 dpi
- Print/convert to editable text (OCR): 300 dpi
- Fax: 200 dpi

Parent topic: [Selecting Epson Scan Settings](#)

Selecting Scan File Settings

You can select the location, name, and format of your scan file on the File Save Settings window. You can also select various optional settings that control how Epson Scan behaves when you scan and save files.

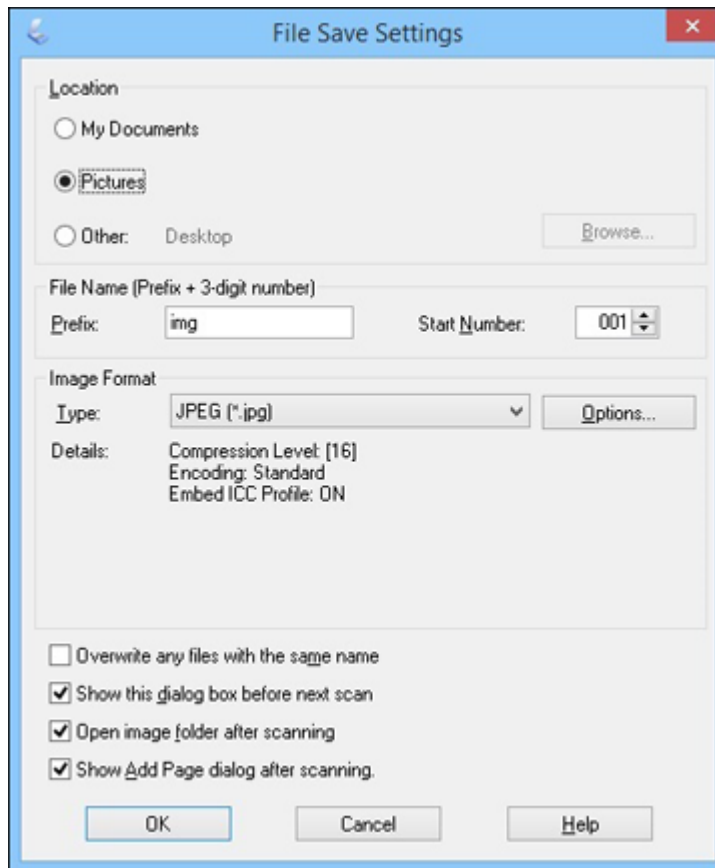

The File Save Settings window may appear after you click **Scan** on the Epson Scan window. You may also be able to access the window by clicking the  icon on the Epson Scan window.

1. Do one of the following to select the folder in which you want to save your scanned image:
 - Click the button for one of the displayed folders.

- Click the **Other** button, click the **Browse** or **Choose** button, and select a folder.
- 2. Type in a file name in the **Prefix** field. This name is used along with numbers to automatically name your scanned files.
- 3. Select a different number as the **Start Number** setting, if you like.
- 4. Select the file format you want to use in the Image Format **Type** menu.
- 5. If your file format provides optional settings, click the **Options** button to select them.
- 6. Choose any of the optional settings you want to use by selecting their checkboxes.
- 7. Click **OK**.

[Available Scanned File Types and Optional Settings](#)

Parent topic: [Selecting Epson Scan Settings](#)

Available Scanned File Types and Optional Settings

You can select from a variety of scanned file types and optional settings on the File Save Settings window in Epson Scan.

File Formats

Bitmap (*.bmp)

A standard image file format for most Windows programs.

JPEG (*.jpg)

An image format that lets you highly compress image data. However, the higher the compression, the lower the image quality. (The TIFF format is recommended when you need to modify or retouch your scanned image.)

Multi-TIFF (*.tif)

A TIFF file format when multiple pages are saved to the same file, allowing you to edit the images using a compatible program.

PDF (*.pdf)

A document format that is readable by Windows and OS X systems using Adobe Reader, Acrobat, or other programs. You can save multi-page documents in one PDF file.

PICT (*.pct)

A standard image file format for most OS X programs.

PRINT Image Matching II (*.jpg or *.tif)

File formats that include Epson PRINT Image Matching II data for enhanced quality and a wider color range (does not affect the way the image displays on the screen).

TIFF (*.tif)

A file format created for exchanging data between many programs, such as graphic and DTP software.

Optional Settings**Overwrite any files with the same name**

Select to overwrite previous files with the same names.

Show this dialog box before next scan

Select to have the File Save Settings window appear automatically before you scan (in certain Epson Scan modes).

Open image folder after scanning

Select to have Windows Explorer or OS X Finder automatically open to the folder where your scanned image is saved after scanning.

Show Add Page dialog after scanning

If you are scanning a multi-page document using the PDF or Multi-TIFF format, select to display a prompt for scanning additional pages after the first page is scanned.

Parent topic: [Selecting Scan File Settings](#)

Scanning with OS X Using Image Capture

With OS X, you can scan with your product using an image-editing application such as Image Capture.

Note: With OS X, in addition to scanning with Image Capture, you can download and install Epson Scan scanning software. Epson Scan provides additional image adjustment and photo correction features for enhancing scanned images, and provides an interface for TWAIN-compliant OCR scanning software. To download Epson Scan, visit Epson's driver download site ([U.S. downloads](#) or [Canadian downloads](#)).

1. Open an image editing application, such as Image Capture.
2. Select your Epson product from the **DEVICES** or **SHARED** list in the Finder, if necessary. (You may need to hover over the **DEVICES** or **SHARED** list, click **Show**, and select your product.)
3. If you see the **Show Details** button, click it.

If you are scanning an item on the scanner glass, your product begins a preview scan.

4. Select the **Scan Mode** setting indicating where you placed your original (if available). Select any other available scan settings as necessary.

The image shows a software interface for configuring a scanner. The settings are organized into several sections, each separated by a horizontal line. At the bottom, there are three buttons: 'Hide Details', 'Overview', and 'Scan'.

- Scan Mode:** Flatbed
- Kind:** Color
- Resolution:** 50 dpi
- Use Custom Size
- Size:** 0 inches
- Rotation Angle:** 0°
- Auto Selection:** Detect Separate Items
- Scan To:** Pictures
- Name:** Scan
- Format:** JPEG
- Image Correction:** None
- Unsharp Mask:** None
- Descreening:** None
- Backlight Correction:** None
- Dust Removal:** None
- Color Restoration
- Quiet Mode:** Off

5. Select the folder in which you want to save your scanned file in the **Scan To** pop-up menu.
6. Click **Scan**.

Your scanned file is saved in the folder you selected.

[Available Scan Settings - OS X Image Capture](#)

Parent topic: [Scanning](#)

Available Scan Settings - OS X Image Capture

You can select these scan settings in your imaging editing application for OS X, if available.

Image Correction

Provides a graphical interface for adjusting brightness, tint, temperature, and saturation.

Unsharp Mask

Makes the edges of certain image areas clearer. Turn off this option to leave softer edges.

Descreening

Removes the ripple pattern that might appear in subtly shaded image areas, such as skin tones. This option improves results when scanning magazines or newspapers. (The results of descreening do not appear in the preview image, only in your scanned image.)

Backlight Correction

Removes shadows from photos that have too much background light.

Dust Removal

Removes dust marks from your originals automatically.

Color Restoration

Restores the colors in faded photos automatically.

Quiet Mode

Reduces noise during scanning and may reduce scan speed.

Parent topic: [Scanning with OS X Using Image Capture](#)

Scanning Special Projects

Your product's scanning software offers various options to help you quickly complete special scan projects.

[Scanning to a PDF File](#)

[Restoring Photo Colors as You Scan](#)

Parent topic: [Scanning](#)

Scanning to a PDF File

Using Epson Scan in Office, Home, or Professional Mode, you can scan a multi-page document and save it in one PDF (Portable Document Format) file on your computer.

1. Place your original on your product for scanning.
2. Start Epson Scan.
3. Select the scan mode you want to use.
4. Select the scan settings for your scan.
5. Preview your image.
6. When you finish selecting all your settings, click **Scan**.

You see the File Save Settings window.

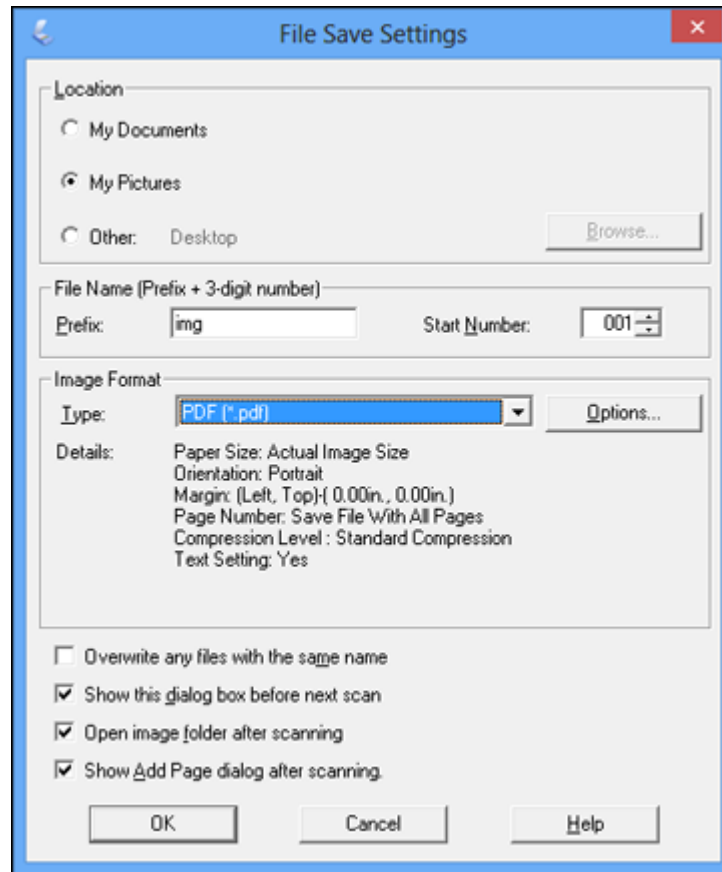

7. Select **PDF** as the Type setting.
8. Select any other settings you want to use on the File Save Settings window. Click the **Options** button to access additional settings.
9. Click **OK**.

Epson Scan scans your document and you see this window:

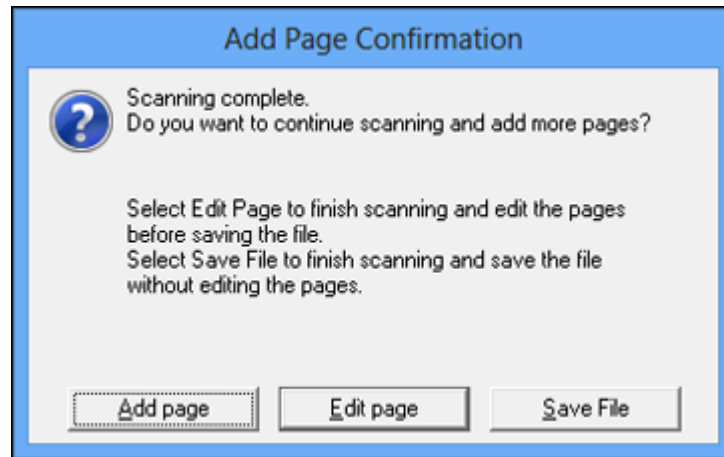

10. Choose one of the following options:

- If you are scanning only one page, click **Save File**.
- If you need to scan additional pages in a document, click **Add page**. Place additional pages on the product for scanning, click **Scan**, and repeat until you have scanned all the pages. When you are finished, click **Save File**.
- If you need to delete or reorder the scanned pages, click **Edit page**. Delete or reorder the pages using the icons that appear on the bottom of the editing window. When you are finished, click **OK**.

Note: If you installed an OCR (Optical Character Recognition) program, you may see a screen indicating the program is converting your page to text. Wait until the program re-scans the page and close the program, if necessary.

11. Click **Close** to exit the Epson Scan window, if necessary.

Epson Scan scans your original, and saves the PDF file in the selected folder or opens it in your scanning program. If the file was saved directly to your computer, you see the file in the Windows Explorer or OS X Finder, where you can view and print the document, if desired.

Parent topic: [Scanning Special Projects](#)

Related tasks

[Starting a Scan Using the Epson Scan Icon](#)

[Selecting the Scan Mode](#)
[Selecting Scan File Settings](#)

Restoring Photo Colors as You Scan

You can restore the colors in faded photos as you scan them using Epson Scan's Color Restoration setting. You can select this setting in any of the available scan modes.

Note: Color restoration is not available in Office Mode, if Epson Scan offers that mode.

1. Place your original on your product for scanning.
2. Start Epson Scan.
3. Select the scan mode you want to use.
4. Select the scan settings for your scan.
5. Preview your image.
6. Locate or access the image adjustment settings.
7. Select the **Color Restoration** checkbox.



8. When you finish selecting all your settings, click **Scan**.
9. Click **Close** to exit the Epson Scan window, if necessary.

Epson Scan scans your original, and saves the color-restored file in the selected folder or opens it in your scanning program. If the file was saved directly to your computer, you see the file in the Windows Explorer or OS X Finder, where you can view and print the image, if desired.

Parent topic: [Scanning Special Projects](#)

Related tasks

[Starting a Scan Using the Epson Scan Icon](#)

[Selecting the Scan Mode](#)

[Placing Originals on the Scanner Glass](#)

Related topics

[Selecting Epson Scan Settings](#)

Faxing

See these sections to fax using your product.

Note: This product allows you to store names, telephone numbers, and fax data in its memory even when the power is turned off. Make sure you restore all of the default settings if you give away or dispose of the product. This will erase all of your network settings and fax data.

[Connecting a Telephone or Answering Machine](#)

[Setting Up Fax Features](#)

[Setting Up Contacts and Contact Groups](#)

[Sending Faxes](#)

[Receiving Faxes](#)

Connecting a Telephone or Answering Machine

You must connect your product to a telephone wall jack to send or receive faxes. If you want to use the same telephone line to receive calls, you can connect a telephone or answering machine to your product using an additional phone cable.

Note: If you do not connect a telephone to your product, make sure Receive Mode is set to **Auto**. Otherwise, you cannot receive faxes.

1. Connect a phone cable to your telephone wall jack and to the **LINE** port on your product.

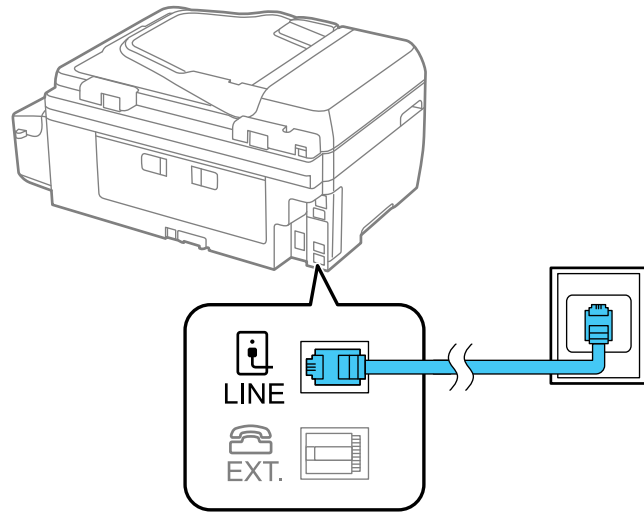

Note: If you have a DSL or ISDN connection, you must connect the appropriate DSL filter, or ISDN terminal adapter or router to the wall jack to be able to use the line for faxing or voice calls using your product. Contact your DSL or ISDN provider for the necessary equipment.

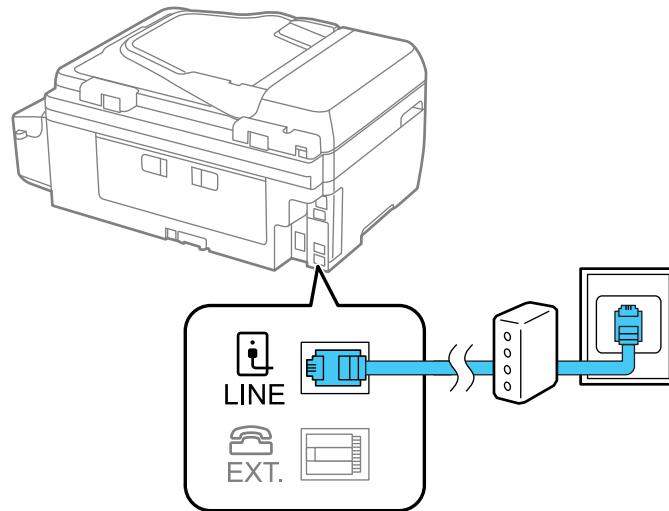

2. If you are connecting a telephone or answering machine to your product using a second phone cable, remove the cap from the **EXT** port on your product.
3. Connect a second phone cable to your telephone or answering machine and to the **EXT** port on your product.

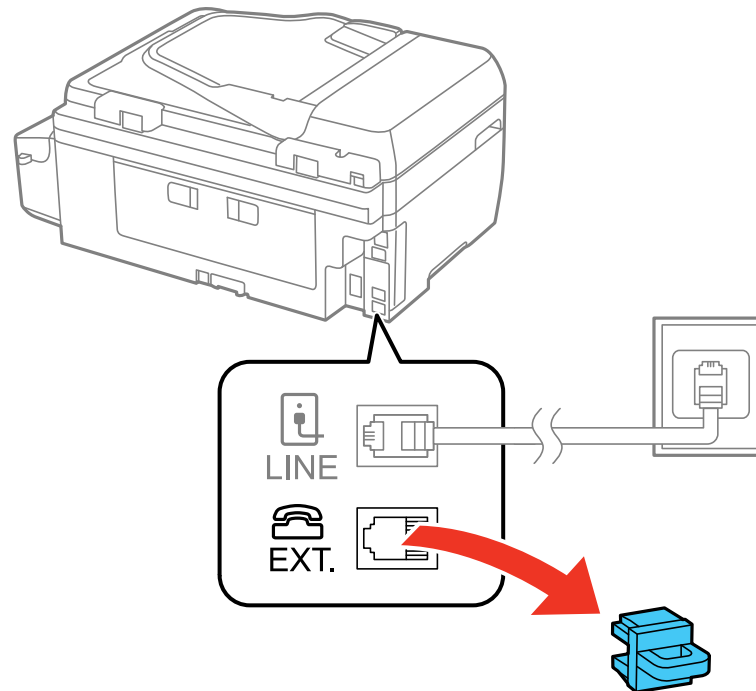

Note: If you connect an answering machine and Receive Mode is set to **Auto**, set the number of rings before your product answers a call to a number that is higher than your answering machine's setting for the number of rings.

Any phone or answering machine must be connected to the **EXT** port for your product to detect an incoming fax call when the phone is picked up. Epson cannot guarantee compatibility with VoIP, cable phone systems, or fiberoptic digital services such as FIOS.

Parent topic: [Faxing](#)

Setting Up Fax Features

Before faxing with your product, set up your fax header and select the fax features you want to use.

Note: If you leave your product unplugged for a long period of time, you may need to reset the date and time settings for faxes.

[Setting Up Fax Features Using the Product Control Panel](#)

[Setting Up Fax Features Using the Fax Utility - Windows](#)

[Setting Up Fax Features Using the Fax Utility - OS X](#)

Parent topic: [Faxing](#)

Related tasks

[Receiving Faxes Automatically](#)

Setting Up Fax Features Using the Product Control Panel

See these sections to set up fax features using the product control panel.

[Selecting Your Country or Region](#)

[Selecting the Date and Time](#)

[Using the Fax Setting Wizard](#)

[Selecting the Line Type](#)

[Setting the Number of Rings to Answer](#)

[Selecting Advanced Fax Settings](#)

[Basic Settings - Fax](#)

[Receive Settings - Fax](#)

[Output Settings - Fax](#)

[Security Settings - Fax](#)

[Printing Fax Reports](#)

[Fax Report Options](#)

Parent topic: [Setting Up Fax Features](#)

Related tasks

[Setting Up Fax Features Using the Fax Utility - Windows](#)

[Setting Up Fax Features Using the Fax Utility - OS X](#)

Selecting Your Country or Region

Before faxing, select the country or region in which you are using your product.

Note: If you change the country or region, your fax settings return to their defaults and you must select them again. This setting can be locked by an administrator. If you cannot access or change this setting, contact your administrator for assistance.

1. Press the up or down arrow button, select **Setup**, and press the **OK** button.
2. Press the up or down arrow button, select **Common Settings**, and press the **OK** button.

You see this screen:

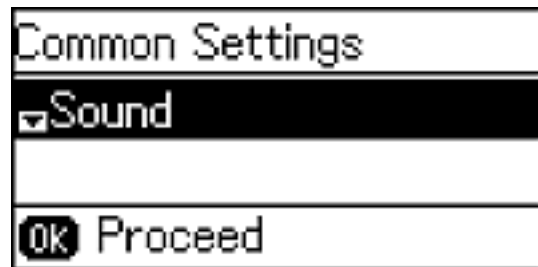

3. Press the up or down arrow button, select **Country/Region**, and press the **OK** button.
4. Scroll up or down, if necessary, to select your country or region.
You see a confirmation screen.
5. If the setting is correct, press the up arrow button to select **Yes**. (If not, press the down arrow button and retry.)

Note: Changing the country or region restores the fax settings to their defaults.

Parent topic: [Setting Up Fax Features Using the Product Control Panel](#)

Selecting the Date and Time

Before faxing, select the current date, time, and daylight saving phase in your area, and choose your preferred date and time format.

1. Press the up or down arrow button, select **Setup**, and press the **OK** button.
2. Press the up or down arrow button, select **Common Settings**, and press the **OK** button.

3. Press the up or down arrow button, select **Date/Time Settings**, and press the **OK** button.

You see a screen like this:

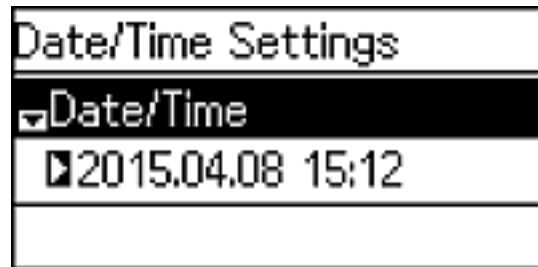

4. Press the up or down arrow button, select **Date/Time**, and press the **OK** button.
5. Select the date format you want to use.
6. Use the numeric keypad to enter the current date and press the **OK** button.
7. Select the time format you want to use and press the **OK** button.
8. Use the numeric keypad to enter the current time and press the **OK** button.
9. Press the up or down arrow button, select **Date/Time Settings**, and press the **OK** button.
10. Press the up or down arrow button, select **Daylight Saving Time**, and press the **OK** button.
11. Select the setting that applies to your area:

- **Winter:** it is winter or your region does not use Daylight Saving Time (DST)
- **Summer:** it is spring or summer and your region uses Daylight Saving Time (DST)

Note: If your region uses Daylight Saving Time (DST), you must change this setting to match the season. When you change from **Winter** to **Summer**, your product automatically sets its clock ahead one hour. When you change from **Summer** to **Winter**, it sets its clock back one hour.

12. If necessary, select **Time Difference** and use the up or down arrow button to set the difference between UTC (Coordinated Universal Time) and your time zone.

Parent topic: [Setting Up Fax Features Using the Product Control Panel](#)

Using the Fax Setting Wizard

You can set up the product's basic fax settings using the Fax Setting Wizard. This wizard is automatically displayed when the product is turned on for the first time. You can also change these settings individually from the Fax Settings menu.

1. Press the up or down arrow button, select **Setup**, and press the **OK** button.
2. Press the up or down arrow button, select **Fax Settings** and press the **OK** button.

You see this screen:

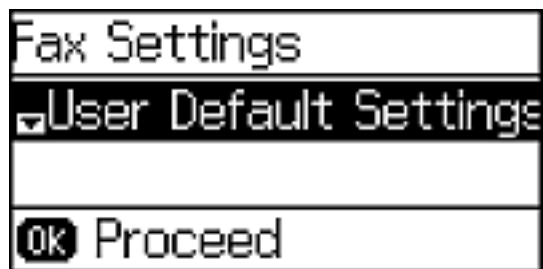

3. Press the up or down arrow button, select **Fax Setting Wizard**, and press the **OK** button.
4. Press the up arrow button to start setting up your fax settings.
5. Use the numeric keypad to enter the sender name for your fax source, such as your name or a business name. You can enter up to 40 characters. Press the **OK** button when you are done.
6. Use the numeric keypad to enter your fax number, up to 20 characters. Press the **OK** button when you are done.
7. On the Distinctive Ring Setting screen, do one of the following:
 - If you have subscribed to a distinctive ring service from your telephone company, press the up arrow button. Then, select the ring pattern to be used for incoming faxes and go to step 10.
 - If you do not have distinctive ring service, press the down arrow button and go to the next step.

Note:

- Distinctive ring service allows you to have several phone numbers on one phone line. Each number is assigned a different ring pattern. You can use one number for voice calls and another for fax calls. Select the ring pattern assigned to fax calls in the DRD Setting.
- If you select **On** or one of the ring patterns other than **All**, Receive Mode is automatically set to **Auto**.

8. Do one of the following:
 - If you connected an external telephone or answering machine to the product's **EXT** port, press the up arrow button and go to the next step.
 - If you did not connect an external telephone or answering machine, press the down arrow button and go to step 11.
9. Do one of the following:
 - If you connected an external telephone or answering machine to the product's **EXT** port, press the up arrow button to receive faxes automatically or press the down arrow to receive them manually.

Note: If you have connected an external answering machine and selected to receive faxes automatically, make sure the **Rings to Answer** setting is correct. If you select to receive faxes manually, you need to answer every call and use the product's control panel or your phone to receive faxes.
 - If you did not connect an external telephone or answering machine, press the up arrow button to receive faxes automatically.

Note: When no external telephone is connected to the product, Receive Mode must be set to **Auto**; otherwise you cannot receive faxes.
10. Press the **OK** button.
11. On the Confirm Settings screen, confirm the displayed settings and press the **OK** button. (Press the  back button if you need to correct or change the settings.)
12. Press the **OK** button to check the fax connection and print a report of the check result. If there are any errors reported, try the solutions on the report, and run the check again.

Note:

- If the Select Line Type screen is displayed, select the correct line type.
- If the Select Dial Tone Detection screen is displayed, select **Disable**. However, disabling the dial tone detection function may drop the first digit of a fax number and send the fax to the wrong number.

Parent topic: [Setting Up Fax Features Using the Product Control Panel](#)

Selecting the Line Type

If you connect the product to a PBX (Private Branch Exchange) phone system or terminal adapter, you must change the product's line type. PBX is used in office environments where an external access code such as "9" must be dialed to call an outside line. The default Line Type setting is PSTN (Public Switched Telephone Network), which is a standard phone line, similar to the one in your home.

Note: This setting can be locked by an administrator. If you cannot access or change this setting, contact your administrator for assistance.

1. Press the up or down arrow button, select **Setup**, and press the **OK** button.
2. Press the up or down arrow button, select **Fax Settings**, and press the **OK** button.
3. Press the up or down arrow button, select **Basic Settings**, and press the **OK** button.
4. Press the up or down arrow button, select **Line Type**, and press the **OK** button.

You see this screen:

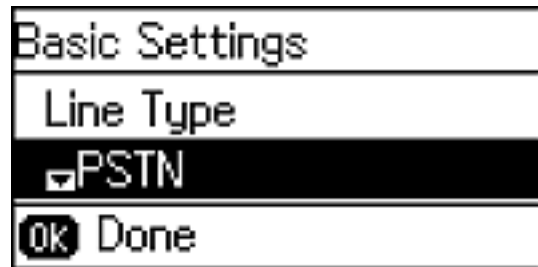

5. If you connected the product to a PBX phone system, select **PBX**.

You see this screen:

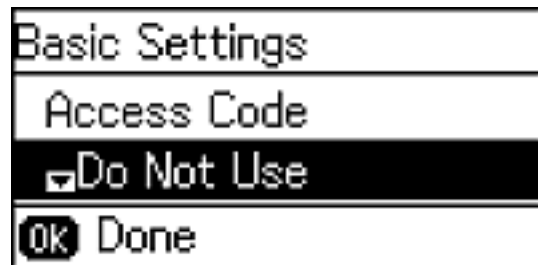

6. Select **Use** and press the **OK** button.
7. To enter an access code number (**9** for example), use the numeric keypad to enter the code number and press the **OK** button.

Parent topic: [Setting Up Fax Features Using the Product Control Panel](#)

Setting the Number of Rings to Answer

If you connect an external answering machine and select to receive faxes automatically, make sure the **Rings to Answer** setting is correct. The number of rings should be higher than the number of rings your answering machine is set to for answering a call.

1. Press the up or down arrow button, select **Setup**, and press the **OK** button.
2. Press the up or down arrow button, select **Fax Settings**, and press the **OK** button.
3. Press the up or down arrow button, select **Receive Settings**, and press the **OK** button.
4. Select **Rings to Answer** and press the **OK** button.

You see this screen:

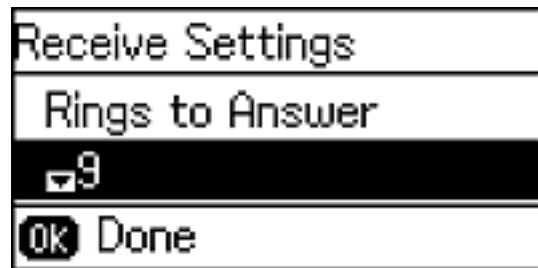

5. Select the number of rings and press the **OK** button. Make sure to select a number higher than the number of rings your answering machine is set to for answering a call.

Note: The answering machine picks up every call faster than the product, but the product can detect fax tones and start receiving faxes. If you answer the phone and hear a fax tone, check that the product has started receiving the fax, then hang up.

Parent topic: [Setting Up Fax Features Using the Product Control Panel](#)

Selecting Advanced Fax Settings

You can use the product's control panel to select settings for sending, receiving, and printing faxes.

1. Press the up or down arrow button, select **Setup**, and press the **OK** button.
2. Press the up or down arrow button, select **Fax Settings**, and press the **OK** button.

You see this screen:

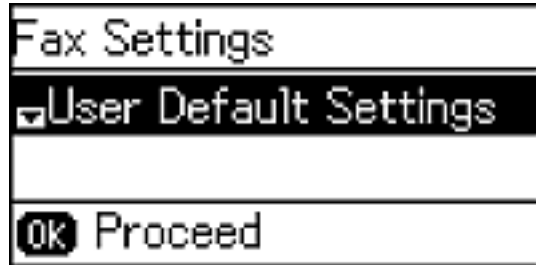

3. Select the group of settings you want to change.

Parent topic: [Setting Up Fax Features Using the Product Control Panel](#)

Related references

- [Basic Settings - Fax](#)
- [Receive Settings - Fax](#)
- [Output Settings - Fax](#)
- [Security Settings - Fax](#)

Basic Settings - Fax

Set the basic options you want to use for incoming and outgoing faxes.

Setting	Options	Description
Fax Speed	Fast(33,600bps)	Sets the speed at which you transmit and receive faxes.
	Medium(14,400bps)	
	Slow(9,600bps)	
ECM	On	Turns on Error Correction Mode (ECM) to automatically correct errors in sent or received fax data.
	Off	Turns off Error Correction Mode (ECM)—color faxes cannot be sent or received.

Setting	Options	Description
Dial Tone Detection	On	Automatically dials the number you enter for faxing when the product detects a dial tone.
	Off	Turns off automatic dial tone detection, which may be necessary if the product is connected to a PBX (Private Branch Exchange) or a TA (Terminal Adapter). The product may drop the first digit of a fax number and send the fax to the wrong number.
Line Type	PSTN	Selects a standard phone line (Public Switched Telephone Network).
	PBX	Selects Private Branch Exchange, the type of phone line used in office environments where an access code such as 9 must be used to call an outside line
Header	Fax Header	Lets you set up the header information for outgoing faxes.
	Your Phone Number	

Parent topic: [Setting Up Fax Features Using the Product Control Panel](#)

Receive Settings - Fax

Set the receive options you want to use for incoming faxes.

Setting	Options	Description
Receive Mode	Manual	Lets you confirm whether an incoming fax should be printed; a telephone must be connected to the product.
	Auto	Automatically receives and prints faxes.
DRD	All	If you are using a Distinctive Ring Service on your phone line, your telephone company can assign two or more phone numbers to the same line and assign different ring patterns to each. If you use this service, select the number of rings for your fax number so your product can receive faxes on the correct number of rings. All works for phone lines that do not use this service.
	Single	
	Double	
	Triple	
	Double&Triple	

Setting	Options	Description
Rings to Answer	1 to 9	Sets the number of rings before your product receives a fax. If Receive Mode is set to Auto and an answering machine is connected to the product, make sure this setting is set higher than the number of rings your answering machine is set to for answering a call.
Remote Receive	Off	Lets you start receiving faxes using your phone instead of operating the product (if the Receive Mode is set to Auto). When you enable this function, you need to set a start code. If you are using a cordless handset whose base is connected to the product, you can start receiving the fax by entering the code on the handset.
	On	

Parent topic: [Setting Up Fax Features Using the Product Control Panel](#)

Output Settings - Fax

Set the output options you want to use for incoming faxes.

Setting	Options	Description
Fax Output	—	Saves incoming faxes to a computer. To use this option, you must use the Epson FAX Utility.
Auto Reduction	On	Select to reduce the size of large received faxes to fit on the paper size in the selected paper source.
	Off	Select to print large incoming faxes at their original size on multiple sheets, if necessary.
Auto Rotation	On	If you have loaded A5-size paper, select On to rotate landscape-oriented incoming faxes so that they print correctly on the paper.
	Off	
Collation Stack	On	Select On to print incoming faxes so that the pages are stacked in the correct page order. (When the product is low on memory, this option may not be available.)
	Off	

Setting	Options	Description
Print Suspend Time	Off	Select On to set a time period to stop automatic printing of faxes or reports and save received faxes in the product's memory. (Make sure there is enough free memory before using this function.)
	On	
Attach Image to Report	Off	Does not include an image of the fax on transmission reports.
	On(Small Image)	Prints transmission reports with an image of the first faxed page.
	On(Large Image)	
Fax Log Auto Print	Off	Does not print the fax log.
	On(Every 30)	Prints the fax log after 30 faxes are sent or received.
	On(Time)	Prints the fax log at a time you select using the numeric keypad displayed on the LCD screen.
Report Format	Simple	Selects the amount of information on fax reports.
	Detail	

Parent topic: [Setting Up Fax Features Using the Product Control Panel](#)

Security Settings - Fax

Set the security options you want to use for fax data.

Setting	Options	Description
Backup Data Auto Clear	Off	Automatically erases sent or received fax data remaining in your product's memory
	On	
Clear Backup Data	—	Deletes all sent or received fax data remaining in your product's memory; run this function if you are giving away or disposing of your product

Parent topic: [Setting Up Fax Features Using the Product Control Panel](#)

Printing Fax Reports

You can select from several fax reports to print whenever necessary. You can also have the fax log printed automatically by selecting **Setup > Fax Settings > Output Settings > Fax Log Auto Print**.

1. Press the up or down arrow button, select **Fax**, and press the **OK** button.

You see a screen like this:

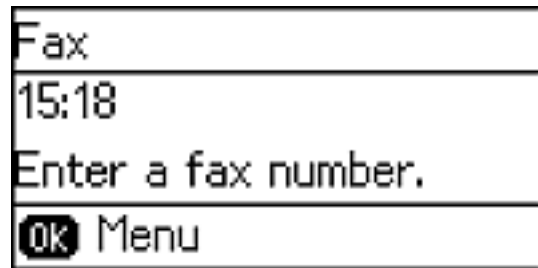

2. Press the **OK** button.
3. Press the up or down arrow button, select **Fax Report**, select the report you want to print, and press one of the **Start** buttons.

Parent topic: [Setting Up Fax Features Using the Product Control Panel](#)

Related references

[Fax Report Options](#)

Fax Report Options

Select the fax report or list you want to print.

Fax Settings List

Print a list of the current fax communication settings.

Fax Log

View or print a report on recent fax transmissions.

Last Transmission

Print a report on the previous fax that was sent or received through polling.

Protocol Trace

Print a detailed report for the previous sent or received fax.

Parent topic: [Setting Up Fax Features Using the Product Control Panel](#)

Setting Up Fax Features Using the Fax Utility - Windows

You can set up your fax header and select your fax settings using the FAX Utility for Windows.

1. Do one of the following:
 - **Windows 8.x:** Navigate to the **Apps** screen.

- **Windows (other versions):** Click  or **Start > Programs** or **All Programs > EPSON Software**.
2. Select **FAX Utility**.
You see this window:



3. Select **Fax Settings for Printer**. (Select your product, if prompted.)

You see this window:

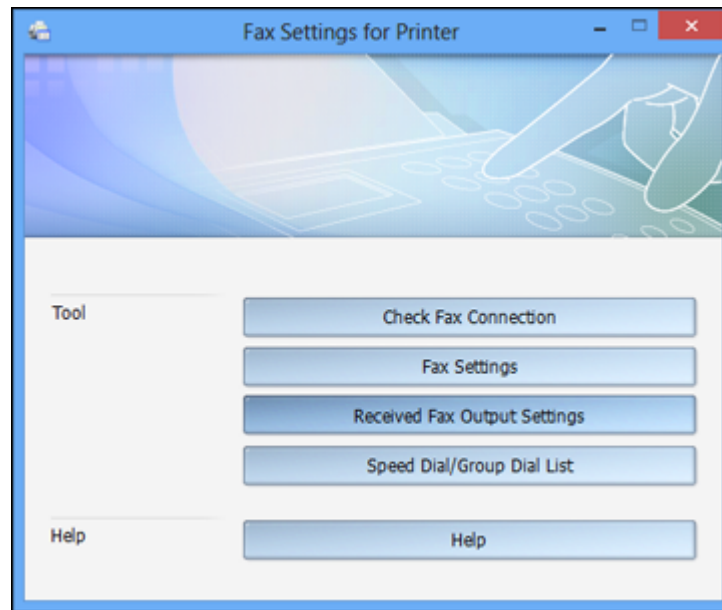

4. Select **Fax Settings**.
5. Follow the prompts that appear on the screen to enter your fax header information and select your fax settings.

Note: For detailed information, select the FAX Utility **Help** option.

Parent topic: [Setting Up Fax Features](#)

Related topics

[Setting Up Fax Features Using the Product Control Panel](#)

Setting Up Fax Features Using the Fax Utility - OS X

You can set up your fax header and select your fax settings using the FAX Utility for OS X.

1. In the Apple menu or the Dock, select **System Preferences**. Select **Print & Fax**, **Print & Scan**, or **Printers & Scanners**, select the **FAX** option for your product, and select **Options & Supplies**. Select **Utility** and select **Open Printer Utility**.

2. Double-click **FAX Utility**, if necessary.

You see this window:

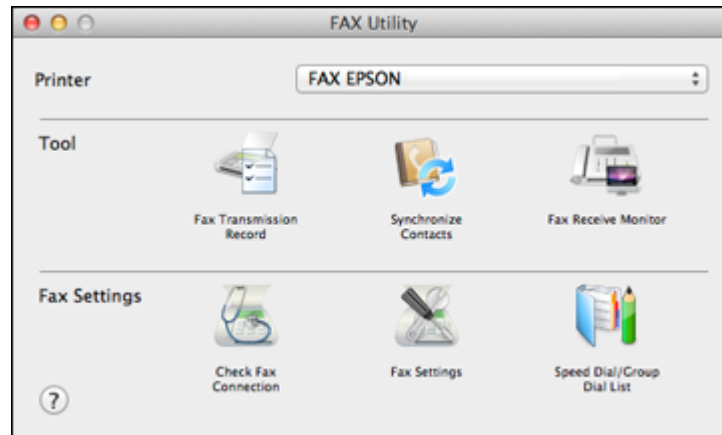

3. Select your **FAX** product in the Printer list.
4. Select **Fax Settings**.
5. Follow the prompts that appear on the screen to enter your fax header information and select your fax settings.

Note: For detailed information, select the FAX Utility ? icon.

Parent topic: [Setting Up Fax Features](#)

Related topics

[Setting Up Fax Features Using the Product Control Panel](#)

Setting Up Contacts and Contact Groups

You can set up a list of contacts and their fax numbers so you can quickly select them for faxing. You can also set up contact groups to send a fax message to multiple contacts.

[Setting Up Contacts Using the Product Control Panel](#)

[Setting Up Speed/Group Dial Lists Using the Fax Utility - Windows](#)

[Setting Up Speed/Group Dial Lists Using the Fax Utility - OS X](#)

Parent topic: [Faxing](#)

Setting Up Contacts Using the Product Control Panel

You can set up your contacts and contact groups using the control panel on your product.

[Creating a Contact](#)

[Editing or Deleting a Contact](#)

[Creating a Contact Group](#)

[Editing or Deleting a Group](#)

Parent topic: [Setting Up Contacts and Contact Groups](#)

Related tasks

[Setting Up Speed/Group Dial Lists Using the Fax Utility - Windows](#)

[Setting Up Speed/Group Dial Lists Using the Fax Utility - OS X](#)

Creating a Contact

You can create a list of contacts to save frequently used fax numbers.

Note: You can create up to 60 contacts and contact groups combined.

1. Press the up or down arrow button, select **Fax**, and press the **OK** button.

You see a screen like this:

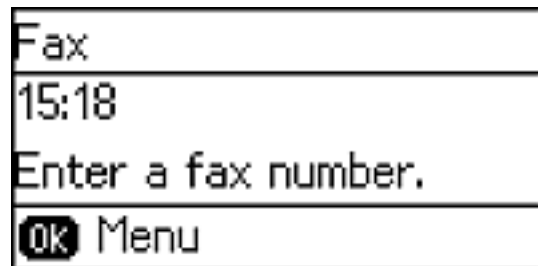

2. Press the  **Contacts** button.

You see a screen like this:



3. Press the # button on the numeric keypad.

You see a screen like this:

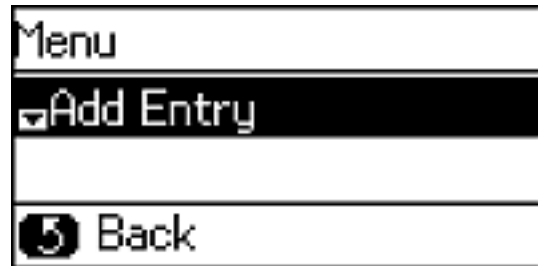

Note: You can print your list of contacts and groups if necessary.

4. Select **Add Entry** and press the **OK** button.
5. Use the buttons on the numeric keypad to enter the number you want to use for the contact, such as **1**. Then press the **OK** button.

You see a screen like this:

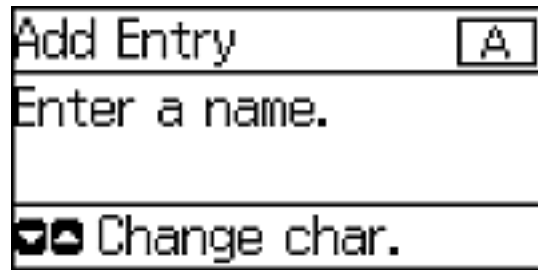

Add Entry A

Enter a name.

 Change char.

6. Use the buttons on the numeric keypad to enter the contact name (up to 30 characters), and press the **OK** button.
7. Use the buttons on the numeric keypad to enter the fax number (up to 64 characters) and press the **OK** button.

Note: If necessary, enter an outside line access code (such as **9**) at the beginning of the fax number. If the access code has been set up in the **Line Type** setting, enter the **#** pound sign instead of the code.

8. Set the **Fax Speed** if necessary.
9. Press the **OK** button.

Parent topic: [Setting Up Contacts Using the Product Control Panel](#)

Editing or Deleting a Contact

You can edit or delete any of the contacts on your list.

1. Press the up or down arrow button, select **Fax**, and press the **OK** button.

You see a screen like this:

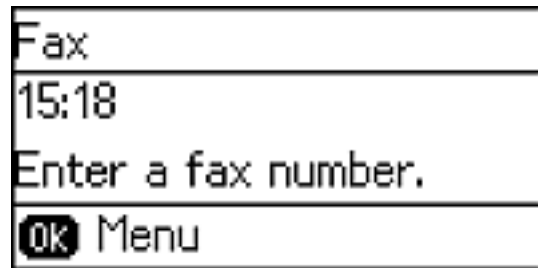

2. Press the  **Contacts** button.
3. Select the contact you want to edit or delete, and press the right arrow button.

You see a screen like this:

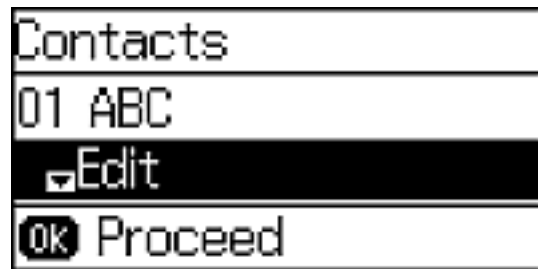

4. Do one of the following:
 - To delete the contact, select **Delete** and press the up arrow button on the confirmation screen.
 - To edit the contact, select **Edit** and follow the on-screen instructions.

Parent topic: [Setting Up Contacts Using the Product Control Panel](#)

Creating a Contact Group

You can create a group of contacts so that you can easily send faxes to multiple recipients. You can have up to 30 contacts in a group.

Note: You can create up to 60 contacts and contact groups combined.

1. Press the up or down arrow button, select **Fax**, and press the **OK** button.

You see a screen like this:

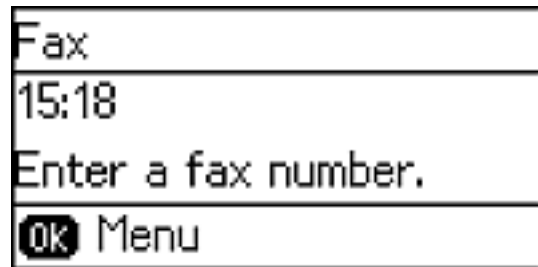

2. Press the  **Contacts** button.
3. Press the **#** button on the numeric keypad.

You see a screen like this:

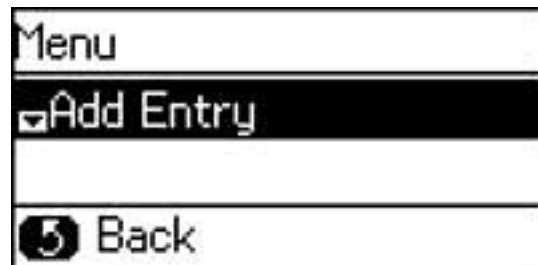

Note: You can print your list of contacts and groups if necessary.

4. Select **Add Group** and press the **OK** button.

You see a screen like this:

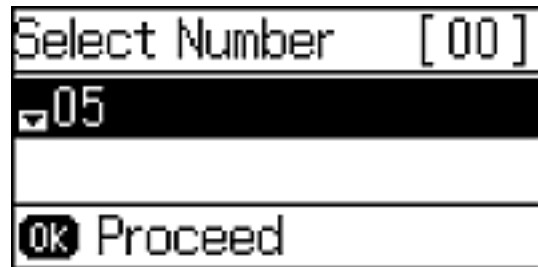

A screenshot of a device screen with a monospaced font. The top line reads "Select Number [00]". Below it, a black bar contains the number "05" with a small white arrow pointing left. The bottom line features a button labeled "OK" followed by the text "Proceed".

5. Select the number you want to use for the group, such as **1**, and press the **OK** button.
6. Use the numeric keypad to enter the group name (up to 30 characters) and press the **OK** button.
You see your contacts list.
7. Press the * button on the numeric keypad for each contact you want to include in your group (up to 30 contacts).
A * symbol appears next to each selected contact.
8. Press the **OK** button to save the group.

Parent topic: [Setting Up Contacts Using the Product Control Panel](#)

Editing or Deleting a Group

You can edit an existing group to add or delete entries. You can also delete the entire group.

1. Press the up or down arrow button, select **Fax**, and press the **OK** button.

You see a screen like this:

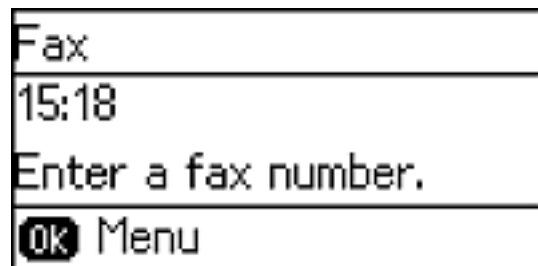

A screenshot of a device screen with a monospaced font. The top line reads "Fax". The second line shows the time "15:18". The third line reads "Enter a fax number.". The bottom line features a button labeled "OK" followed by the text "Menu".

2. Press the  **Contacts** button.

You see a screen like this:

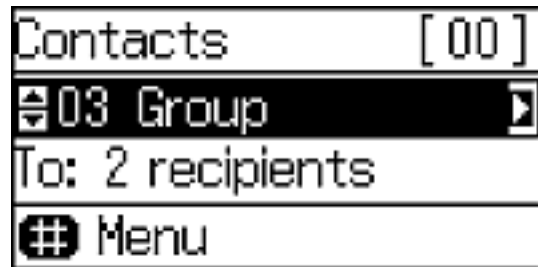

3. Select the group you want to edit and press the right arrow button.

You see a screen like this:

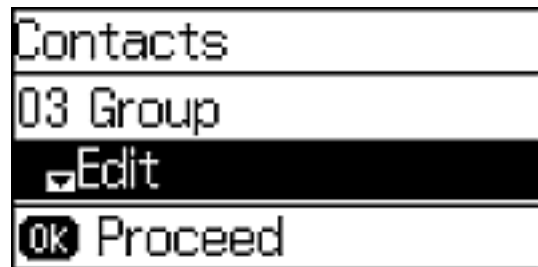

4. Do one of the following:
 - To delete the group, select **Delete** and press the **OK** button. Press the up arrow button on the confirmation screen.
 - To edit the group, select **Edit** and press the **OK** button. Edit the group as necessary and press the **OK** button.

You see a list of the contacts in your group.

5. To add or delete a contact, press the * button on the numeric keypad.
6. Press the **OK** button to save the settings.

Parent topic: [Setting Up Contacts Using the Product Control Panel](#)

Setting Up Speed/Group Dial Lists Using the Fax Utility - Windows

You can set up your speed dial and group dial lists using the FAX Utility for Windows. The utility also lets you import fax numbers from the Windows Address Book and back up fax numbers stored in your product's memory.

Note: You can create up to 60 speed dial and group dial entries combined.

1. Do one of the following:
 - **Windows 8.x:** Navigate to the **Apps** screen.
 - **Windows (other versions):** Click  or **Start > Programs** or **All Programs > EPSON Software**.
2. Select **FAX Utility**.

You see this window:



3. Select **Fax Settings for Printer**. (Select your product, if prompted.)

You see this window:

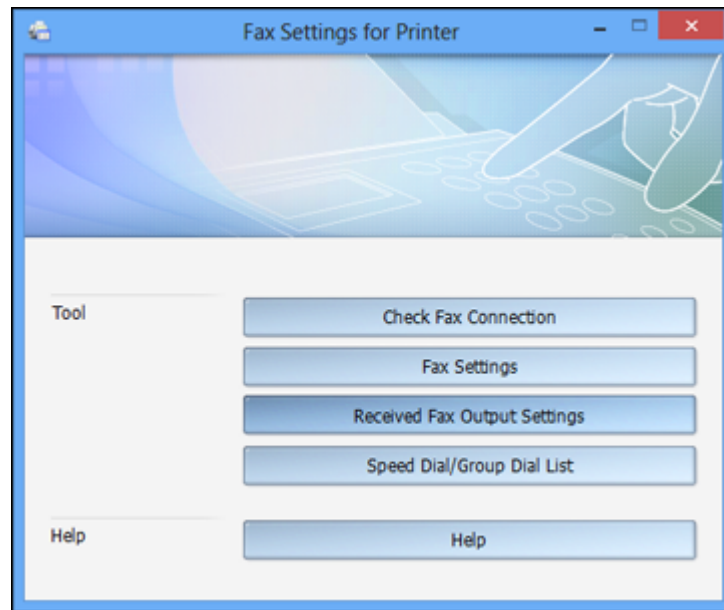

4. Select **Speed Dial/Group Dial List**.

You see this window:

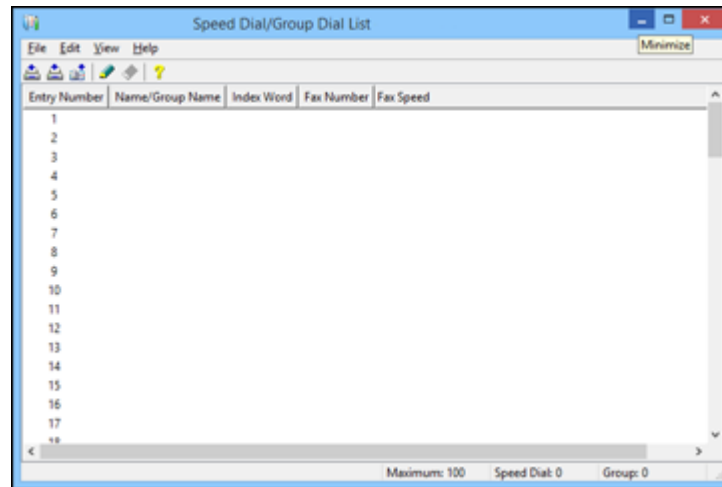

5. Select an empty entry and click the  icon.

Note: To edit an entry, select it and click the  icon. To delete an entry, select it and click the  icon.

6. Do one of the following:
 - To create a speed dial entry, select **Speed Dial**, enter a name and fax number, and click **OK**.
 - To create a group dial entry, select **Group**, enter a name, select your desired fax numbers, and click **OK**.
7. Repeat the previous steps as necessary to add all your speed dial or group dial entries.
8. When you are finished, click the  icon to save the entries to your product's memory.

Parent topic: [Setting Up Contacts and Contact Groups](#)

Related topics

[Setting Up Contacts Using the Product Control Panel](#)

Setting Up Speed/Group Dial Lists Using the Fax Utility - OS X

You can set up your speed dial and group dial lists using the FAX Utility. The utility also lets you import fax numbers from the MacAddress Book and back up fax numbers to your product's memory.

Note: You can create up to 60 speed dial and group dial entries combined.

1. In the Apple menu or the Dock, select **System Preferences**. Select **Print & Fax**, **Print & Scan**, or **Printers & Scanners**, select the **FAX** option for your product, and select **Options & Supplies**. Select **Utility** and select **Open Printer Utility**.
2. Double-click **FAX Utility**, if necessary.

You see this window:

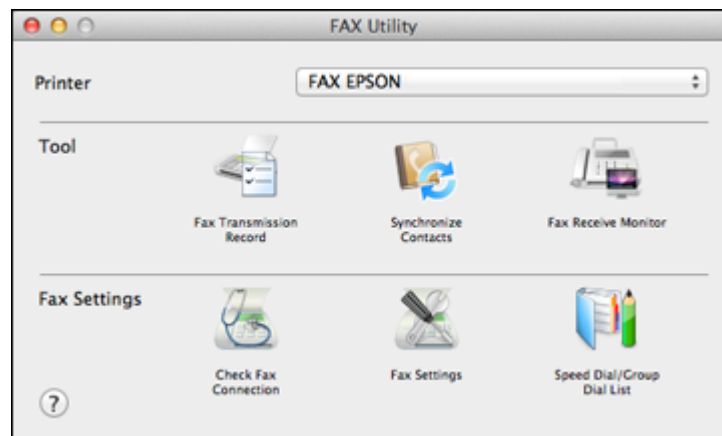

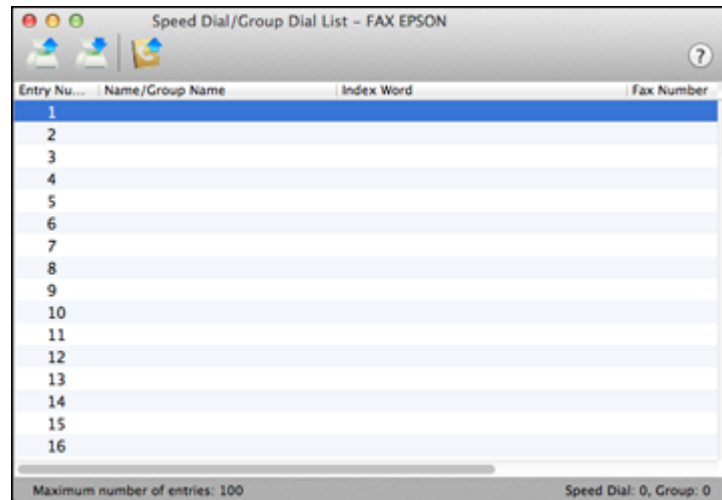

3. Select your **FAX** product in the Printer list.
4. Select **Speed Dial/Group Dial List**.

You see this window:



5. To add an entry, double-click an empty entry.

Note: To edit an entry, select it and change the information. To delete an entry, select it and press the **Delete** key on your keyboard.

6. Do one of the following:
 - To create a speed dial entry, select **Speed Dial**, enter a name and fax number, and click **OK**.
 - To create a group dial entry, select **Group Dial**, enter a name, select your desired fax numbers, and click **OK**.
7. Repeat the previous steps as necessary to add all your speed dial or group dial entries.
8. To import entries from your MacAddress book, click the  icon.
9. When you are finished, click the  icon to save the entries to your product's memory.

Parent topic: [Setting Up Contacts and Contact Groups](#)

Related topics

[Setting Up Contacts Using the Product Control Panel](#)

Sending Faxes

See these sections to send faxes using your product.

[Sending Faxes from the Product Control Panel](#)

[Sending Faxes Using the Fax Utility - Windows](#)

[Sending Faxes Using the Fax Utility - OS X](#)

Parent topic: [Faxing](#)

Sending Faxes from the Product Control Panel

See these sections to send faxes using the product's control panel.

[Faxing from the Control Panel](#)

[Fax Send Settings](#)

[Dialing Fax Numbers from a Connected Telephone](#)

[Sending a Fax at a Specified Time](#)

Parent topic: [Sending Faxes](#)

Related references

[Fax Send Settings](#)

Related tasks

[Selecting the Line Type](#)

Related topics

[Placing Originals on the Product](#)

[Setting Up Contacts Using the Product Control Panel](#)

Faxing from the Control Panel

You can send a fax from your product control panel by entering the fax number or selecting the number from either the contact list or fax history. If direct dialing has been restricted, you can only select the number from the contact list or fax history. You can send black and white faxes to multiple recipients, but not color faxes.

1. Place your original on the product for faxing.
2. Press the up or down arrow button, select **Fax**, and press the **OK** button.

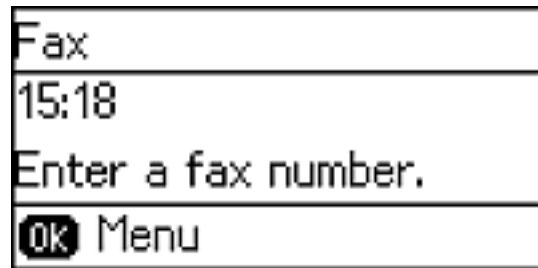

You see a screen like this:



3. Do one of the following:

- Enter the fax number using the buttons on the numeric keypad and press the **OK** button.

Note: If necessary, enter an outside line access code (such as **9**) at the beginning of the fax number. If the access code has been set up in the **Line Type** setting, enter the **#** pound sign instead of the code.

- Press the  **Contacts** button, select one or more recipients from the list, and press the **OK** button.
- Press the  **Redial/Pause** button to redial the last dialed fax number.

4. If you need to change any fax settings, press the **OK** button and select your settings.

Note: If your recipient's fax machine does not print in color, your fax is automatically sent in black-and-white.

5. Press one of the **Start** buttons.

Note: To cancel faxing, press the  **Stop/Reset** button.

Your product scans your original and prompts you to place additional pages, if necessary.

After scanning your originals, your product dials the number and sends the fax.

Parent topic: [Sending Faxes from the Product Control Panel](#)

Fax Send Settings

While sending a fax, you can select these options.

Setting	Options	Description
Resolution	Standard	Adjusts the scan resolution and print quality for outgoing faxes.
	Fine	
	Photo	
Density	Auto Manual	Auto automatically adjusts the darkness of outgoing faxes and Manual lets you select from various density levels.
Direct Send	Off	Sends monochrome faxes to a single recipient as soon as the connection is made, without saving the scanned image to memory. You cannot use this feature when sending a color fax or sending to multiple recipients.
	On	
Transmission Report	Print on Error	Lets you select when to print transmission reports.
	Print	
	Do Not Print	
Send Fax Later	Off	You can set to send a fax at a specified time. Only monochrome faxes can be sent when the time to send is specified.
	On	
Polling Receive	Off	You can receive a fax stored on another fax machine for fax polling by dialing the fax number. You can receive a specific document from a fax information service by following the audio guidance of the service.
	On	
Reprint Faxes	—	Prints received faxes temporarily stored in the printer's memory from the latest one. When the printer runs out of memory, the faxes are automatically deleted from the oldest one. Received faxes stored in the inbox are not automatically deleted.

Setting	Options	Description
Fax Report	Fax Settings List	Prints the current fax settings.
	Fax Log	Prints a transmission report automatically after you send a fax.
	Last Transmission	Prints a report for the previous fax that was sent or received through polling.
	Protocol Trace	Prints a list of fax documents stored in the printer's memory, such as unfinished jobs.

Parent topic: [Sending Faxes from the Product Control Panel](#)

Dialing Fax Numbers from a Connected Telephone

If you have connected a telephone to the **EXT** port on your product, you can send a fax by dialing the number from the connected telephone. If the recipient's phone number and fax number are the same, you can speak to the recipient before sending the fax.

1. Place your original on the product for faxing.

Note: You can send up to 100 pages in a single transmission.

2. Pick up the handset of the connected phone.
3. Select **Send** and dial the fax number from the connected telephone. Speak to the recipient if necessary.

Note: If you are using a pre-paid calling card, enter the number and password required to use the card before entering the destination fax number.

4. Press the **OK** button and select your fax settings.
5. When you hear a fax tone, press one of the **Start** buttons to start sending the fax.
6. Hang up the telephone.

Note: If your recipient's fax machine does not print in color, your fax is automatically sent in black-and-white.

Parent topic: [Sending Faxes from the Product Control Panel](#)

Related references

[Fax Send Settings](#)

Related tasks

[Connecting a Telephone or Answering Machine](#)

Related topics

[Placing Originals on the Product](#)

Sending a Fax at a Specified Time

You can send a fax at a time of your choice.

Note: You can send faxes only in black-and-white when you use this option.

1. Place your original on the product for faxing.
2. Press the up or down arrow button, select **Fax**, and press the **OK** button.

You see a screen like this:

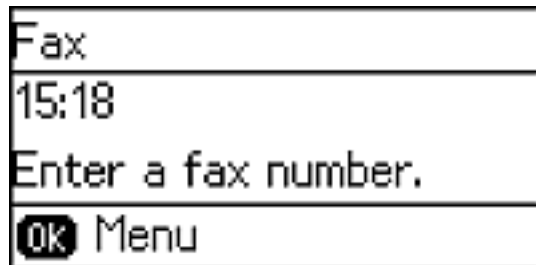

3. Enter a fax number or select a number from the Contacts list and press the **OK** button.

Note: If necessary, enter an outside line access code (such as **9**) at the beginning of the fax number. If the access code has been set up in the **Line Type** setting, enter the **#** pound sign instead of the code.

4. Press the **OK** button to change the fax settings.
5. Select **Send Fax Later** and press the **OK** button.

6. Select **On**, use the buttons on the numeric keypad to enter your desired time, and press the **OK** button.

Note: You cannot send another fax until the delayed fax is sent.

7. Press the ↩ back button.
8. Press one of the **Start** buttons.

Note: To cancel faxing, press the ⏹ **Stop/Reset** button and then press the up arrow button.

After scanning your originals, your product dials the number and sends the fax at the specified time.

Note: If the product is turned off at the specified time, the fax is sent when you turn it back on.

Parent topic: [Sending Faxes from the Product Control Panel](#)

Related topics

[Setting Up Contacts Using the Product Control Panel](#)

[Setting Up Contacts and Contact Groups](#)

[Placing Originals on the Product](#)

Sending Faxes Using the Fax Utility - Windows

You can send a fax from a printing program in Windows. You can fax up to 100 pages at a time, including a cover sheet.

1. Open the file you want to fax and select the print command.

You see a window like this:

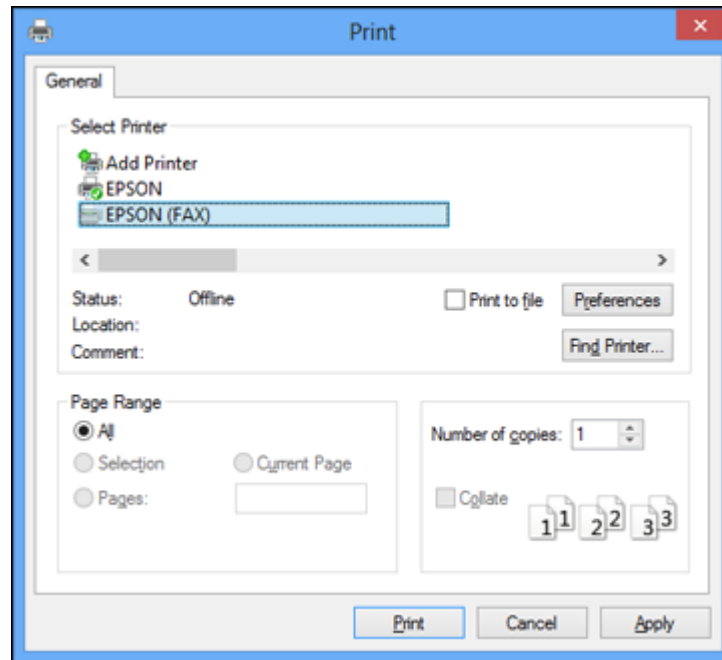

2. Select your product with the **FAX** option as the printer.
3. To change the Paper Size, Orientation, Color, Image Quality, or Character Density settings, click the **Preferences** or **Properties** button.

Note: If you see a **Setup**, **Printer**, or **Options** button, click it. Then click **Preferences** or **Properties** on the next screen. For more information about selecting fax print settings, click **Help**.

4. Select the Page Range as necessary. (Leave the Number of copies set to 1.)
5. Click **Print** or **OK**.

If you're faxing for the first time, you see a window like this one:

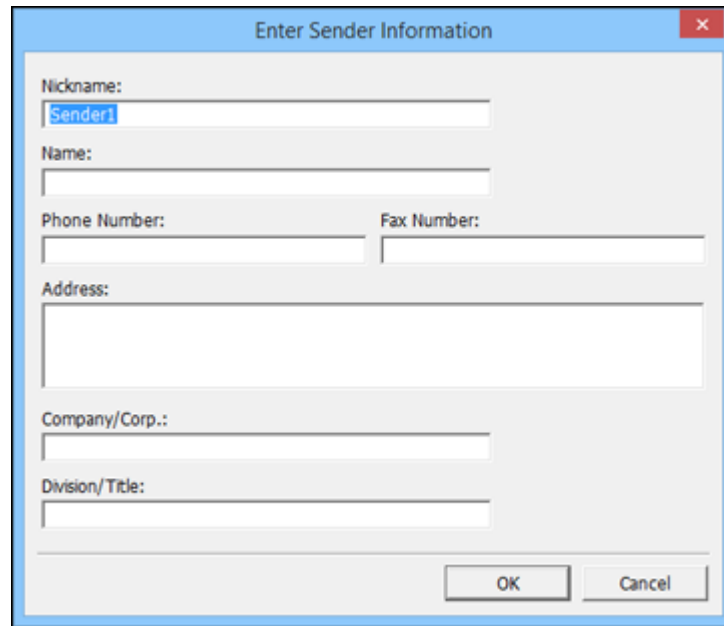

The image shows a dialog box titled "Enter Sender Information" with a close button (X) in the top right corner. The dialog box contains several input fields for user information:

- Nickname:** A text input field containing the text "Sender1".
- Name:** An empty text input field.
- Phone Number:** An empty text input field.
- Fax Number:** An empty text input field.
- Address:** A large, empty text area.
- Company/Corp.:** An empty text input field.
- Division/Title:** An empty text input field.

At the bottom right of the dialog box, there are two buttons: "OK" and "Cancel".

6. Enter your sender information so that recipients can identify the origin of the fax. Then click **OK** to save the sender information.

You see a window like this:

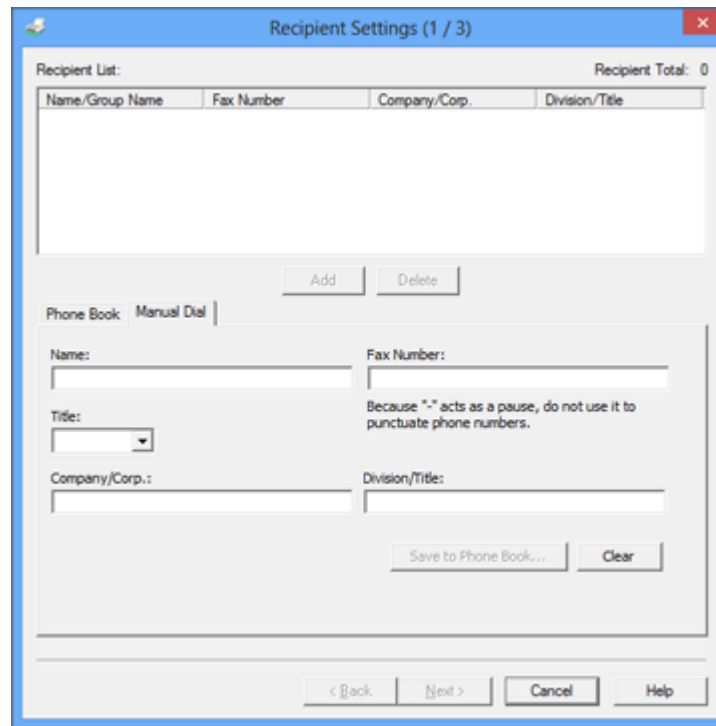

7. Enter the recipient's name and fax number or select a recipient from the phonebook, then click **Next**.

Note: For detailed instructions on using the Epson FAX Utility, click **Help**.

8. Select a cover sheet and enter a subject and message, then click **Next**.
9. Click **Send** to transmit your fax.

Parent topic: [Sending Faxes](#)

Sending Faxes Using the Fax Utility - OS X

You can send a fax from a OS X printing program using the FAX Utility. You can fax up to 100 pages at a time, including a cover sheet.

1. Open the file you want to fax.

2. Select the print command in your application.

Note: You may need to select a print icon on your screen, the **Print** option in the **File** menu, or another command. See your application's help utility for details.

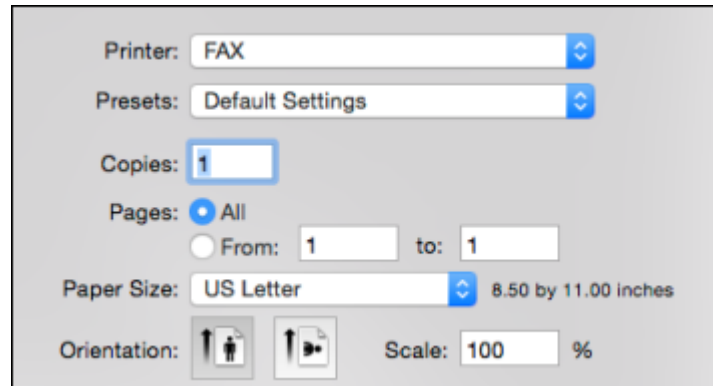

The image shows a print dialog box with the following settings:

- Printer: FAX
- Presets: Default Settings
- Copies: 1
- Pages: All, From: 1 to: 1
- Paper Size: US Letter (8.50 by 11.00 inches)
- Orientation: Portrait, Landscape
- Scale: 100 %

3. Select your product **FAX** option as the **Printer** setting.
4. If necessary, click the arrow next to the Printer setting or the **Show Details** button to expand the print window.
5. Select the number of pages you are faxing as the **Pages** setting.

Note: Leave the **Copies** setting set to 1.

6. Select **Recipient Settings** from the pop-up menu.

You see this window:

Recipient Settings

Recipient List:

Name	Company/Corp.	Fax Number
------	---------------	------------

Add:

Name:

Company/Corp.:

Fax Number:

A hyphen (-) is available only at the beginning of the phone number because it acts as a pause in dialing.

External Access Prefix:

Cancel Fax

7. Do one of the following to choose your recipient:
 - Select a name or group from the **Recipient List**.
 - Enter a name, company, and fax number and click the **+** button.
 - Click the  icon and select a recipient from your address book.
8. Select **Fax Settings** from the pop-up menu.

You see this window:

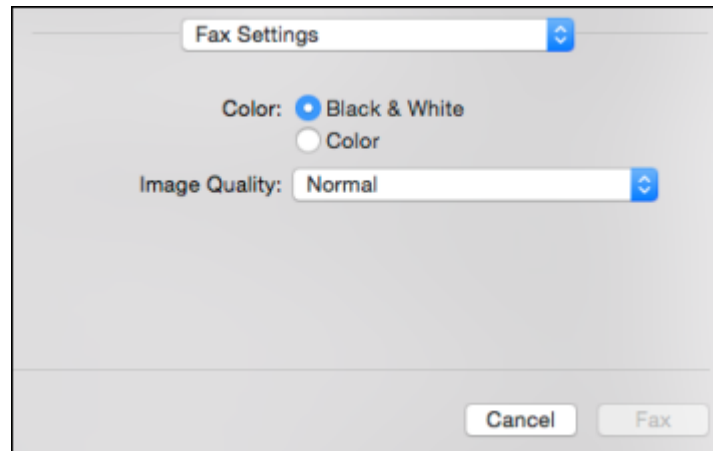

9. Select the **Color** and **Image Quality** settings you want to use for your fax.

10. Click **Fax**.

Parent topic: [Sending Faxes](#)

Receiving Faxes

See these sections to receive faxes with your product.

Note: Do not turn the product off while it is receiving a fax. Otherwise, the fax transmission will be lost.

[Fax Reception](#)

[Receiving Faxes Automatically](#)

[Receiving Faxes Manually](#)

[Receiving a Fax by Polling](#)

Parent topic: [Faxing](#)

Fax Reception

Your product will automatically receive and print faxes when you set the Receive Mode to **Auto**.

If you connected a telephone to your product so you can use the same phone line for faxes and voice calls, you can also set your product to receive faxes manually. This allows you to check for a fax tone using the telephone and press a button on your product to receive the fax.

Make sure to load paper in your product and select your fax settings before receiving a fax.

Note: If you run out of paper during fax printing, load more paper and press the button indicated on your product's LCD screen to continue.

Note: Do not turn the product off while it is receiving a fax. Otherwise, the fax transmission will be lost.

Parent topic: [Receiving Faxes](#)

Receiving Faxes Automatically

To receive faxes automatically, make sure Receive Mode is set to **Auto** (the default setting for the product).

To change the Receive Mode setting if necessary, select **Setup > Fax Settings > Receive Settings > Receive Mode**.

If an answering machine is connected, make sure the product's **Rings to Answer** setting is set higher than the number of rings your answering machine is set to answer a call. For example, if the answering machine is set to pick up on the fourth ring, set the product to pick up on the fifth ring or later.

Parent topic: [Receiving Faxes](#)

Related tasks

[Receiving Faxes Manually](#)

Receiving Faxes Manually

You can set up your product to receive faxes manually by setting the Receive Mode to **Manual**. This lets you check for a fax tone on the connected telephone before receiving a fax.

1. When the connected telephone rings, answer the call.
2. If you hear a fax tone, select **Receive** on the product control panel.
3. Press one of the **Start** buttons to start receiving the fax.
4. Hang up the telephone.

Parent topic: [Receiving Faxes](#)

Related tasks

[Receiving Faxes Automatically](#)

Receiving a Fax by Polling

You can use polling to receive a fax from another fax machine (such as a fax information service).

1. Press the up or down arrow button, select **Fax**, and press the **OK** button.

You see a screen like this:

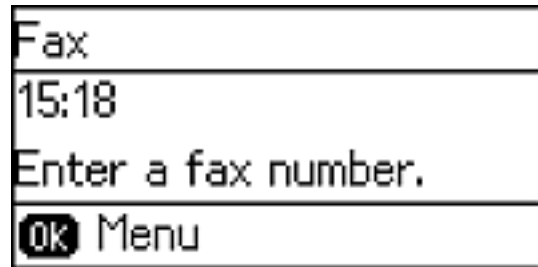

2. Press the **OK** button.
3. Press the up or down arrow button, select **Polling Receive**, and select **On**.
4. Press the \curvearrowright back button.
5. Enter the fax number.
6. Press one of the **Start** buttons to start receiving the fax.

Parent topic: [Receiving Faxes](#)

Refilling Ink

Periodically check the ink tanks to see if they need to be refilled.

Before checking the ink level or refilling an ink tank as described here, be sure to read the ink safety precautions.

Caution: Visually check the ink levels in the product's ink tanks to confirm the actual ink levels. Continued use of the product when the ink is expended could damage the product.

[Ink Safety Precautions](#)

[Check Ink Levels](#)

[Purchase Epson Ink](#)

[Refilling the Ink Tanks](#)

Ink Safety Precautions

Note: The product has a low ink alert system. The accuracy of this system depends on the user refilling the ink tanks correctly. The product cannot directly measure the ink levels in the tanks; instead it estimates the amount of ink remaining by internally monitoring ink usage. The low ink alert system may generate inaccurate messages if the ink tanks are not refilled according to these instructions.

Visually check the ink levels in the product's ink tanks to confirm the actual ink levels. Continued use of the product when the ink is expended could damage the product.

Ink Handling Precautions

- Keep ink bottles and the ink tank unit out of the reach of children. Do not allow children to drink from or handle the ink bottles and bottle caps.
- Do not tilt or shake an ink bottle after removing its seal; otherwise, ink may leak.
- If ink gets on your skin, wash it thoroughly with soap and water. If ink gets into your eyes, flush them immediately with water. If ink gets into your mouth, spit it out immediately. Seek medical advice if problems persist.

Ink Refilling Precautions

- Use ink bottles with the correct part number for this product.
- Do not mix with other Epson ink types.

- The use of non-Epson ink may cause damage that is not covered by Epson's warranty, and under certain circumstances, may cause erratic product behavior.
- This product requires careful handling of ink. Ink may splatter when the ink tanks are filled or refilled with ink. If ink gets on your clothes or belongings, it may not come off.
- Do not open the ink bottle package until you are ready to fill an ink tank. Ink bottles are vacuum packed to maintain reliability. If you leave an ink bottle unpacked for a long time before using it, print quality may be affected.
- Visually check the ink levels in the product's ink tanks to confirm the actual ink levels. Continued use of the product when the ink is expended could damage the product.
- Epson recommends filling an ink tank to the upper line before resetting the ink level.
- For optimum printing results, refill the ink tanks to the upper line at least once a year.
- After bringing an ink bottle inside from a cold storage site, allow it to warm up at room temperature for at least three hours before using it.
- Store ink bottles in a cool, dark place.
- Store the ink bottles in the same environment as the product. When storing or transporting an ink bottle after removing its seal, do not tilt the bottle and do not subject it to impacts or temperature changes. Otherwise, ink may leak even if the cap on the ink bottle is tightened securely. Be sure to keep the ink bottle upright when tightening the cap, and take measures to prevent ink from leaking when you transport the bottle.

Ink Bottle and Ink Tank Information

- To maintain optimum print head performance, some ink is consumed from all ink tanks during printing and when performing maintenance operations, such as cleaning the print head.
- The ink bottles may contain recycled materials, but this does not affect product function or performance.
- When printing in monochrome or grayscale, color ink may be used instead of black ink, depending on the paper type or print quality settings. This is because a mixture of color inks is used to create black.

Parent topic: [Refilling Ink](#)

Check Ink Levels

Your product and its printing software will let you know when an ink tank is low or expended.

[Checking Ink Levels](#)

[Checking Ink Levels with Windows](#)

[Checking Ink Levels with OS X](#)

[Disabling Special Offers with Windows](#)

Parent topic: [Refilling Ink](#)

Checking Ink Levels

To confirm the actual ink levels, visually check the ink levels in the product's ink tanks.

Note: The product has a low ink alert system. The accuracy of this system depends on the user refilling the ink tanks correctly. The product cannot directly measure the ink levels in the tanks; instead it estimates the amount of ink remaining by internally monitoring ink usage. The low ink alert system may generate inaccurate messages if the ink tanks are not refilled according to these instructions.

Visually check the ink levels in the product's ink tanks to confirm the actual ink levels. Continued use of the product when the ink is expended could damage the product.

Parent topic: [Check Ink Levels](#)

Related tasks

[Refilling the Ink Tanks](#)

Checking Ink Levels with Windows

A low ink reminder appears if you try to print when ink is low, and you can check your ink levels at any time using a utility on your Windows computer.

1. To check your ink levels, access the Windows Desktop and double-click the product icon in the Windows taskbar.

You see a window like this:

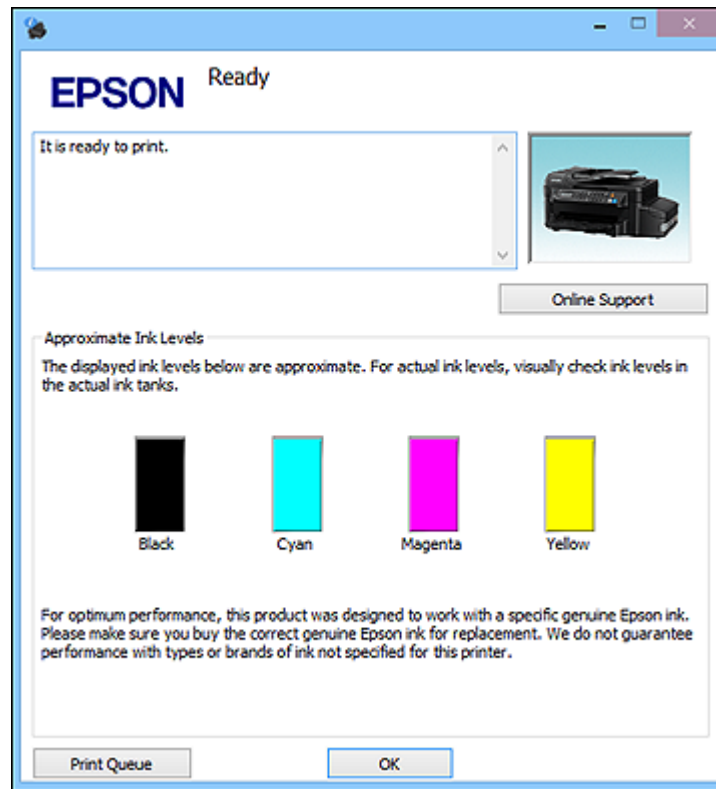

2. Refill any ink tank as needed.

Note: The ink levels displayed are an estimate and may differ from the actual ink remaining in the ink tanks. To confirm the actual remaining ink, visually check the ink levels in the ink tanks. Continued use of the product when the ink level is below the lower line on the tank could damage the product.

Parent topic: [Check Ink Levels](#)

Related tasks

[Refilling the Ink Tanks](#)

Checking Ink Levels with OS X

You can check your ink levels using a utility on your Mac.

1. In the Apple menu or the Dock, select **System Preferences**. Select **Print & Fax**, **Print & Scan**, or **Printers & Scanners**, select your product, and select **Options & Supplies**. Select **Utility** and select **Open Printer Utility**.
2. Select **EPSON Status Monitor**.

You see a window like this:



3. Refill any ink tank as needed.

Note: To update or refresh the displayed ink levels, click **Update**.

Note: The ink levels displayed are an estimate and may differ from the actual ink remaining in the ink tanks. To confirm the actual remaining ink, visually check the ink levels in the ink tanks. Continued use of the product when the ink level is below the lower line on the tank could damage the product.

Parent topic: [Check Ink Levels](#)

Related tasks

[Refilling the Ink Tanks](#)

Disabling Special Offers with Windows

You can disable special offers messages from Epson using a utility on your Windows computer.

1. Right-click the product icon in the Windows taskbar and select **Monitoring Preferences**.

You see this window:

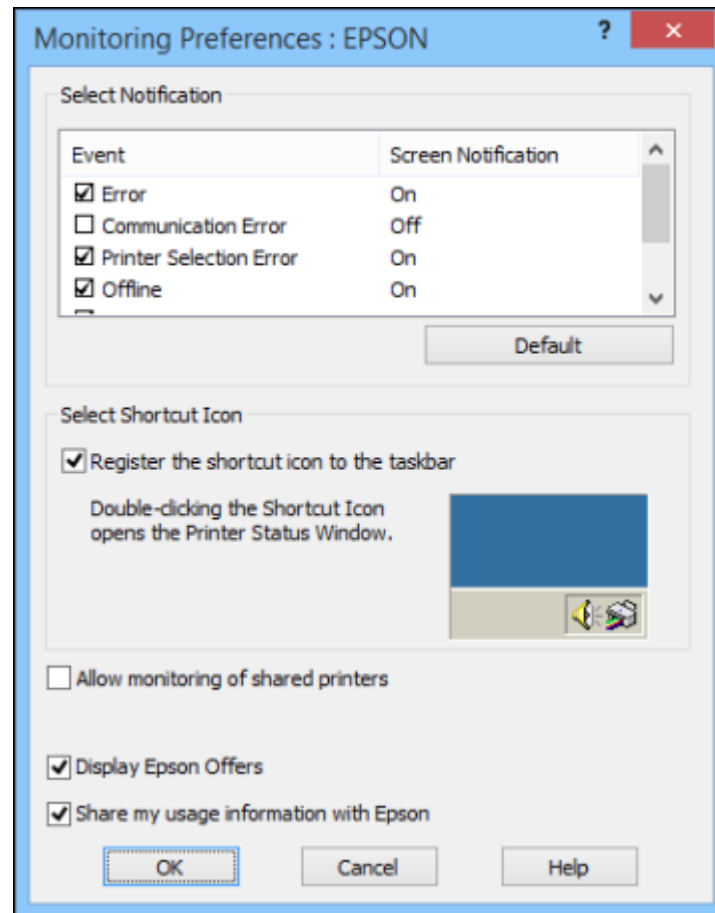

2. To disable promotional offers, deselect the **Display Epson Offers** checkbox.

Parent topic: [Check Ink Levels](#)

Purchase Epson Ink

You can purchase genuine Epson ink and paper at epson.com/ink3 (U.S. sales) or epson.ca (Canadian sales). You can also purchase supplies from an Epson authorized reseller. To find the nearest one, call 800-GO-EPSON (800-463-7766).

Note: This product is designed to work with genuine Epson inks. Non-Epson ink or any other ink not specified for this printer could cause damage not covered by Epson's warranties.

The included initial ink bottles must be used for printer setup and are not for resale. The printer ships with full ink bottles and part of the ink from the first bottles is used to charge the print head. Yields vary considerably based on images printed, print settings, paper type, frequency of use and temperature.

[Ink Bottle Part Numbers](#)

Parent topic: [Refilling Ink](#)

Ink Bottle Part Numbers

Use these part numbers when you order or purchase new ink bottles, and use the ink by the date printed on the package:

Ink color	Part number
Black	774
Cyan	664
Magenta	664
Yellow	664

Parent topic: [Purchase Epson Ink](#)

Refilling the Ink Tanks

Make sure you have new ink bottles handy and have read the ink safety precautions before you begin.

You can continue to use the product even if one or more ink tanks are not filled all the way. However, for the most accurate ink level monitoring, fill all the ink tanks up to the top line. For optimum printing results, refill the ink tanks to the upper line at least once a year.

Caution: Wear disposable gloves while refilling the ink tanks to avoid staining your hands. If ink spills, wipe it off immediately with a damp towel to avoid permanent stains. If ink gets on your clothes or belongings, it may not come off.

1. Place a sheet of paper under the ink tank unit, as ink may splatter.
2. Turn on your product.
3. If you see a message on the LCD screen telling you to reset the ink levels, note the ink tanks that need refilling and press the **OK** button. Otherwise, select **Setup > Maintenance > Reset Ink Levels** and press the **Start** \blacklozenge **Color** button.
4. Open the ink tank unit cover, then remove the ink tank cap and place it in the holder shown here.

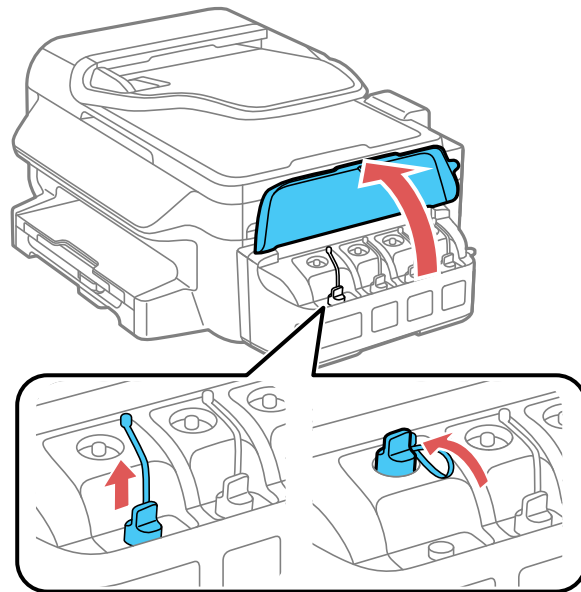

Note: Make sure the color of the ink tank label matches the ink color you want to refill, and only remove the cap from that ink tank. Be careful not to spill any ink.

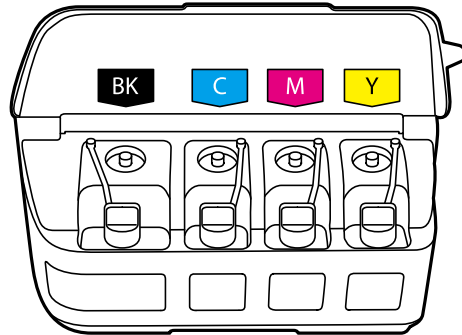

5. Snap off the tip of the bottle cap, but do not dispose of it so you can use it to seal the bottle cap later, if necessary. Then remove the bottle cap and carefully remove the protective seal (avoid touching the ink underneath the seal). Close the bottle cap tightly.

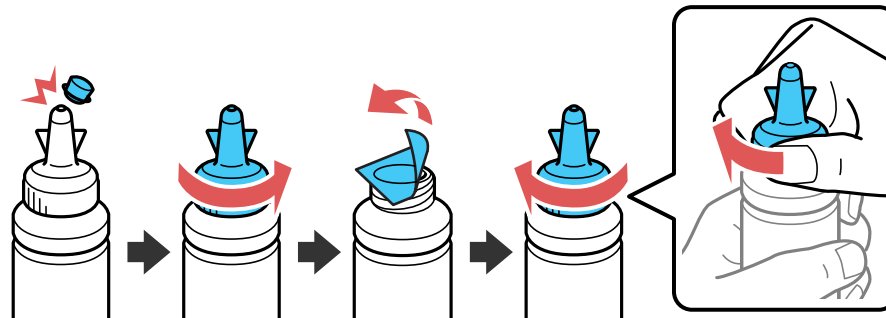

Caution: Close the bottle cap tightly; otherwise, ink may leak.

Warning: If ink gets on your skin, wash it thoroughly with soap and water. If ink gets into your eyes, flush them immediately with water. If ink gets into your mouth, spit it out immediately. Seek medical advice if problems persist. Keep the ink bottles out of the reach of children and do not drink the ink.

6. Refill the ink tank with the correct color ink up to the upper line on the ink tank.

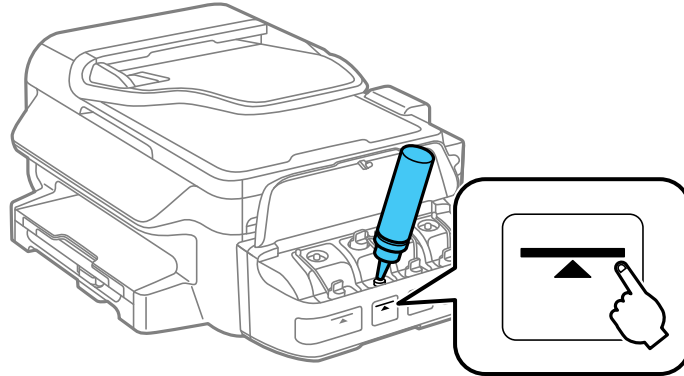

7. If any ink remains in the ink bottle after filling the ink tank, place the bottle cap tip securely on the bottle cap and store the ink bottle upright for later use.

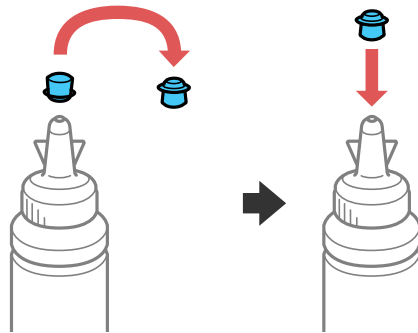

8. Replace the ink tank cap securely.

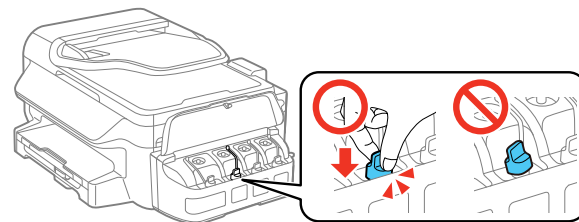

9. Repeat the previous steps as necessary for each ink tank you need to refill.
10. Close the ink tank unit cover.

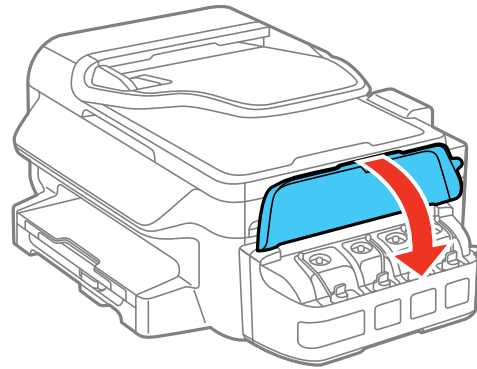

11. Press the **OK** button twice.
You see this screen:

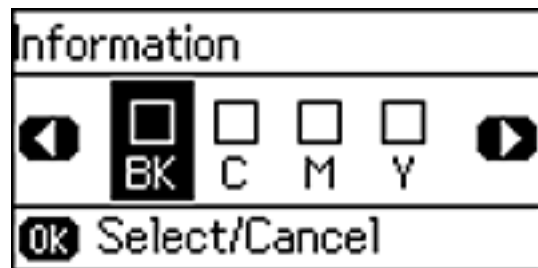

12. Press the left or right arrow buttons to highlight the ink tank you refilled and press the **OK** button to select it. Repeat for each ink tank color you refilled.
13. Press the **Color** button when you are done to reset the ink levels.

Note: The product has a low ink alert system. The accuracy of this system depends on the user refilling the ink tanks correctly. The product cannot directly measure the ink levels in the tanks; instead it estimates the amount of ink remaining by internally monitoring ink usage. The low ink alert system may generate inaccurate messages if the ink tanks are not refilled according to these instructions.

Visually check the ink levels in the product's ink tanks to confirm the actual ink levels. Continued use of the product when the ink is expended could damage the product.

Parent topic: [Refilling Ink](#)

Related concepts

[Purchase Epson Ink](#)

Adjusting Print Quality

If your print quality declines, you may need to run a utility to clean or align the print head.

If running these utilities does not solve the problem, you may need to flush the ink tubes.

[Print Head Maintenance](#)

[Print Head Alignment](#)

[Cleaning the Paper Path](#)

[Checking the Number of Sheets](#)

Print Head Maintenance

If your printouts become too light, or you see dark or light bands across them, you may need to clean the print head nozzles. Cleaning uses ink, so clean the nozzles only if print quality declines.

You can check for clogged nozzles before you clean them so you don't clean them unnecessarily.

Note: You may not be able to clean the print head when the ink level in any of the tanks is low. You may have to refill the ink tank first.

[Print Head Nozzle Check](#)

[Print Head Cleaning](#)

[Power Ink Flushing](#)

Parent topic: [Adjusting Print Quality](#)

Related topics

[Refilling Ink](#)

Print Head Nozzle Check

You can print a nozzle check pattern to check for clogged nozzles.

[Checking the Nozzles Using the Product Control Panel](#)

[Checking the Nozzles Using a Computer Utility](#)

Parent topic: [Print Head Maintenance](#)

Checking the Nozzles Using the Product Control Panel

You can check the print head nozzles using the control panel on your product.

1. Load a few sheets of plain paper in the product.

2. Press the up or down arrow button, select **Setup**, and press the **OK** button.

You see this screen:

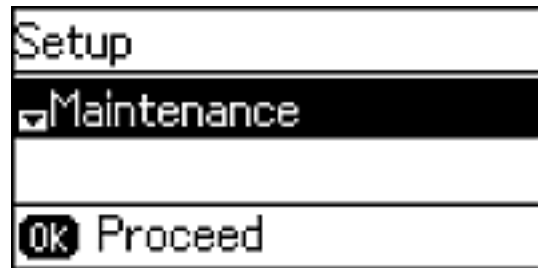

3. Select **Maintenance** and press the **OK** button.
4. Select **Print Head Nozzle Check** and press the **OK** button.
5. Press one of the **Start** buttons to begin printing.
6. Check the printed pattern to see if there are gaps in the lines.

Print head is clean

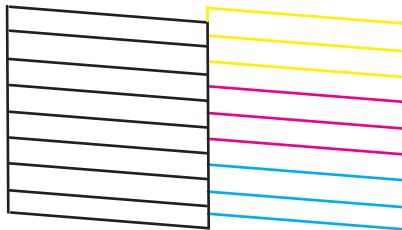

Print head needs cleaning

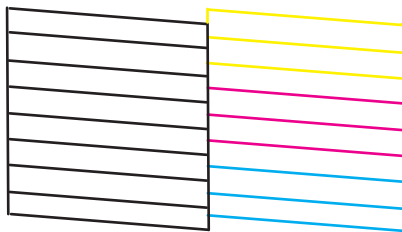

7. Do one of the following:
 - If there are no gaps, select **Finish** and press the **OK** button.
 - If there are gaps or the pattern is faint, select **Clean the print head** and press the **OK** button to continue.
8. Follow the instructions on the screen to clean the print head, check the nozzles, and repeat the process as necessary.

If you don't see any improvement after cleaning the print head up to 3 times, turn off the product and wait at least 12 hours. Then check the print head nozzles and try cleaning the print head again, if necessary. If quality still does not improve, contact Epson.

Parent topic: [Print Head Nozzle Check](#)

Related tasks

[Cleaning the Print Head Using the Product Control Panel](#)

[Loading Paper in the Cassette](#)

Related topics

[Refilling Ink](#)

Checking the Nozzles Using a Computer Utility

You can check the print head nozzles using a utility on your Windows or Mac computer.

1. Make sure there are no errors on the LCD screen.
2. Load a few sheets of plain paper in the product.
3. Do one of the following:
 - **Windows:** Access the Windows Desktop and right-click the product icon in the Windows taskbar.
 - **OS X:** In the Apple menu or the Dock, select **System Preferences**. Select **Print & Fax**, **Print & Scan**, or **Printers & Scanners**, select your product, and select **Options & Supplies**. Select **Utility** and select **Open Printer Utility**.
4. Select **Nozzle Check**.

You see a window like this:

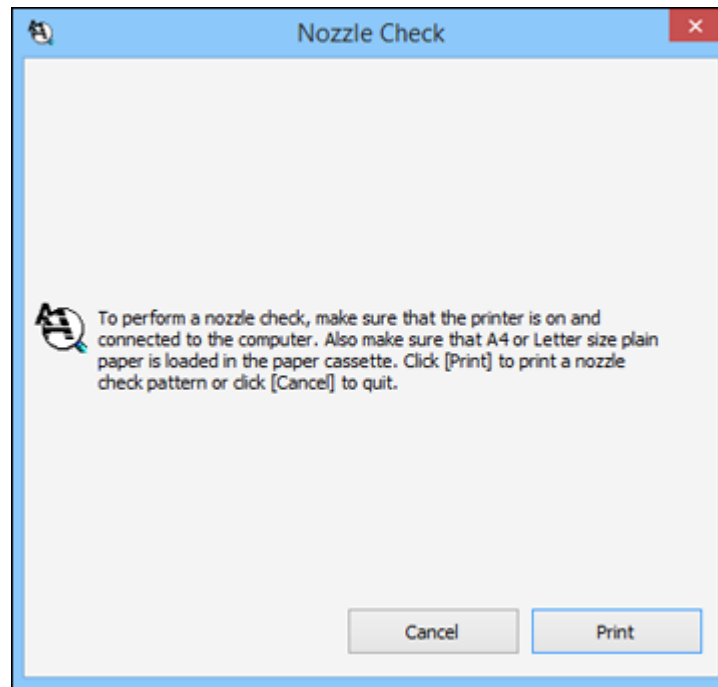

5. Click **Print**.

6. Check the printed pattern to see if there are gaps in the lines.

Print head is clean

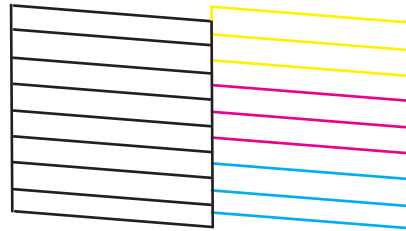

Print head needs cleaning

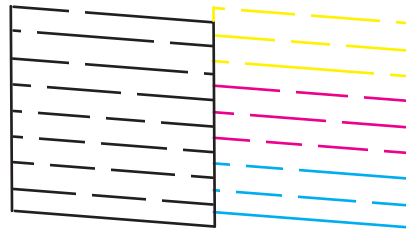

7. If there are no gaps, click **Finish**.

If there are gaps or the pattern is faint, clean the print head.

Parent topic: [Print Head Nozzle Check](#)

Related tasks

[Cleaning the Print Head Using a Computer Utility](#)

[Loading Paper in the Cassette](#)

Related topics

[Refilling Ink](#)

Print Head Cleaning

If print quality has declined and the nozzle check pattern indicates clogged nozzles, you can clean the print head.

Note: You may not be able to clean the print head when the ink level in any of the tanks is low. You may have to refill the ink tank first.

[Cleaning the Print Head Using the Product Control Panel](#)

[Cleaning the Print Head Using a Computer Utility](#)

Parent topic: [Print Head Maintenance](#)

Related topics

[Refilling Ink](#)

Cleaning the Print Head Using the Product Control Panel

You can clean the print head using the control panel on your product.

1. Load a few sheets of plain paper in the product.
2. Press the up or down arrow button, select **Setup**, and press the **OK** button.

You see this screen:

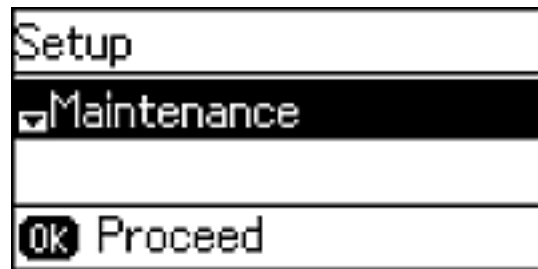

3. Select **Maintenance** and press the **OK** button.
4. Press the up or down arrow button, select **Print Head Cleaning**, and press the **OK** button.
5. Press one of the **Start** buttons to start the cleaning cycle.

The  power light flashes throughout the cleaning cycle and stays on when the cleaning cycle is finished.

Caution: Never turn off the product or open the scanner unit during a cleaning cycle or you may not be able to print.

6. Press the **OK** button to run a nozzle check to confirm that the print head is clean.

If you don't see any improvement after cleaning the print head up to 3 times, turn off the product and wait at least 12 hours. Then check the print head nozzles and try cleaning the print head again, if necessary. If quality still does not improve, contact Epson.

Parent topic: [Print Head Cleaning](#)

Related references

[Where to Get Help](#)

Related tasks

[Checking the Nozzles Using the Product Control Panel](#)

[Loading Paper in the Cassette](#)

Cleaning the Print Head Using a Computer Utility

You can clean the print head using a utility on your Windows or Mac computer.

1. Make sure there are no errors on the LCD screen.
2. Load a few sheets of plain paper in the product.
3. Do one of the following:
 - **Windows:** Access the Windows Desktop and right-click the product icon in the Windows taskbar.
 - **OS X:** In the Apple menu or the Dock, select **System Preferences**. Select **Print & Fax**, **Print & Scan**, or **Printers & Scanners**, select your product, and select **Options & Supplies**. Select **Utility** and select **Open Printer Utility**.
4. Select **Head Cleaning**.

You see a window like this:

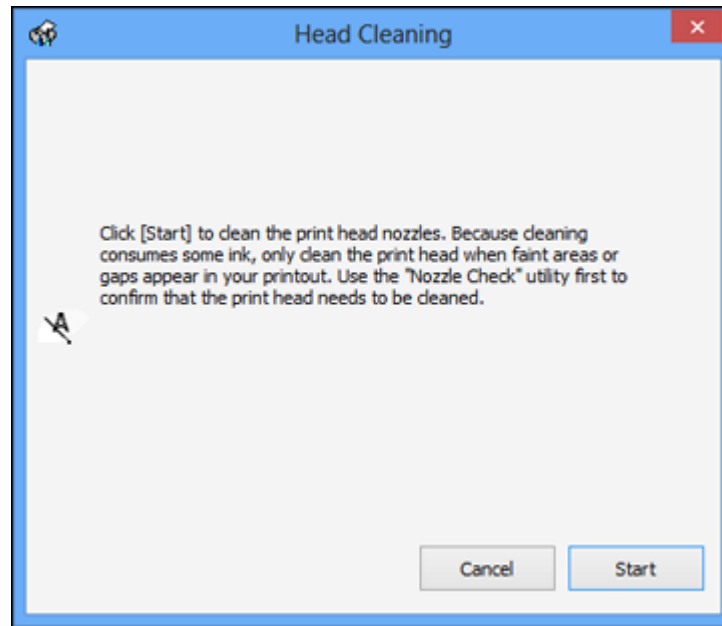

5. Click **Start** to begin the cleaning cycle.

The  power light flashes throughout the cleaning cycle and stays on when the cleaning cycle is finished.

Caution: Never turn off the product or open the scanner unit during a cleaning cycle or you may not be able to print.

6. When the cleaning cycle is finished, you can check to see if the nozzles are clean; click **Print Nozzle Check Pattern** and click **Print**.

7. Check the printed pattern to see if there are gaps in the lines.

Print head is clean

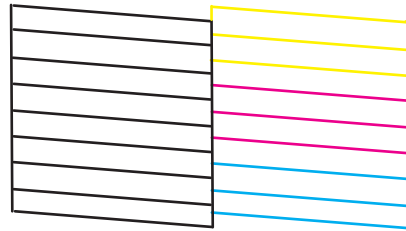

Print head needs cleaning

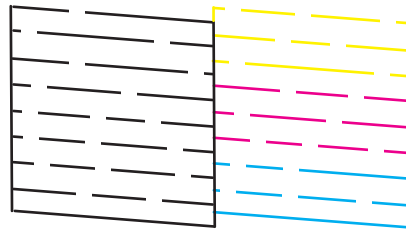

- If there are no gaps, click **Finish**.
- If there are gaps or the pattern is faint, click **Clean** to clean the print head again.

If you don't see any improvement after cleaning the print head up to 3 times, turn off the product and wait at least 12 hours. Then check the print head nozzles and try cleaning the print head again, if necessary. If quality still does not improve, contact Epson.

Parent topic: [Print Head Cleaning](#)

Related references

[Where to Get Help](#)

Related tasks

[Checking the Nozzles Using a Computer Utility](#)

[Loading Paper in the Cassette](#)

Power Ink Flushing

If you still see white or dark lines or missing colors in your printouts, even after cleaning the print head several times, you can perform a Power Ink Flushing.

Note: After a Power Ink Flushing, you must turn off the product and wait at least 12 hours before printing again.

Caution: Power Ink Flushing consumes a lot of ink and should be performed only if necessary. Refill the ink in the ink tanks before performing a Power Ink Flushing.

Power Ink Flushing affects the service life of the ink pads by causing them to reach their capacity sooner. When an ink pad reaches the end of its service life, the product stops printing and you must contact Epson for support.

[Flushing the Ink Using a Computer Utility](#)

Parent topic: [Print Head Maintenance](#)

Related topics

[Refilling Ink](#)

Flushing the Ink Using a Computer Utility

You can use the Power Ink Flushing utility to flush the ink.

Note: After a Power Ink Flushing, you must turn off the product and wait at least 12 hours before printing again.

Before you begin, make sure no product lights are indicating errors.

1. Do one of the following:
 - **Windows:** Access the Windows Desktop and right-click the product icon in the Windows taskbar and select **Printer Settings**. Then click the **Maintenance** tab.
 - **OS X:** In the Apple menu or the Dock, select **System Preferences**. Select **Print & Fax**, **Print & Scan**, or **Printers & Scanners**, select your product, and select **Options & Supplies**. Select **Utility** and select **Open Printer Utility**.
2. Click the **Power Ink Flushing** button.

You see a window like this:

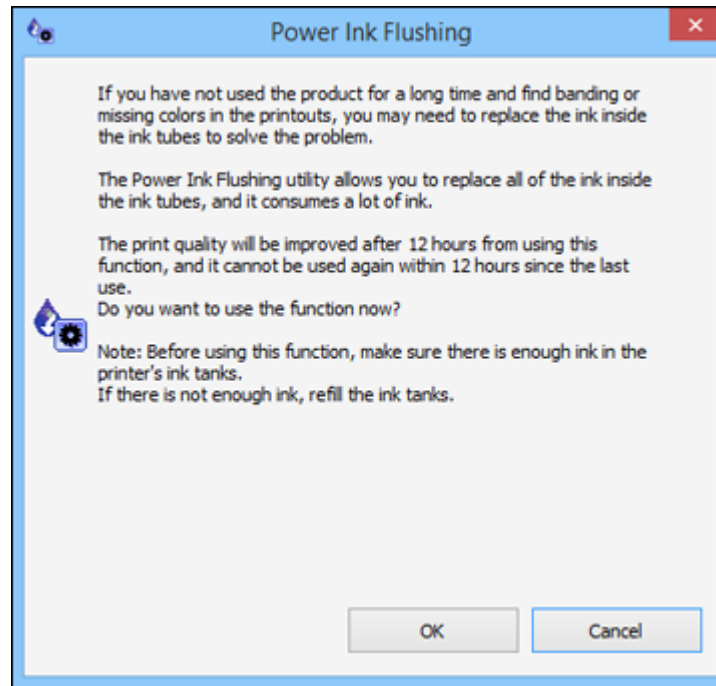

3. Follow the on-screen instructions.
4. When you finish the Power Ink Flushing, turn off the product and wait at least 12 hours before printing.
5. Print a document and check the print quality. If the print quality did not improve, contact Epson for support.

Parent topic: [Power Ink Flushing](#)

Related topics

[Refilling Ink](#)

Print Head Alignment

If your printouts become grainy or blurry, you notice misalignment of vertical lines, or you see dark or light horizontal bands, you may need to align the print head.

Note: Banding may also occur if your print head nozzles need cleaning.

[Aligning the Print Head Using the Product Control Panel](#)

[Aligning the Print Head Using a Computer Utility](#)

Parent topic: [Adjusting Print Quality](#)

Aligning the Print Head Using the Product Control Panel

You can align the print head using the control panel on your product.

1. Load a few sheets of plain paper in the product.
2. Press the up or down arrow button, select **Setup**, and press the **OK** button.

You see this screen:

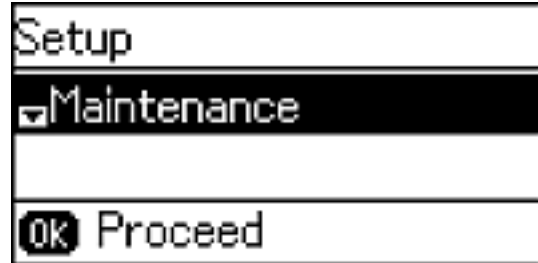

3. Select **Maintenance** and press the **OK** button.
4. Select **Print Head Alignment** and press the **OK** button.
5. Do one of the following:
 - If your printouts look blurry or have misaligned vertical lines, select **Vertical Alignment**.
 - If your printouts has dark or light horizontal bands, select **Horizontal Alignment**.
6. Press the **Start** \blacklozenge **Color** button to print an alignment sheet.

Note: Do not cancel printing while you are printing a head alignment pattern.

7. Check the printed patterns on the alignment sheet and do one of the following:
- If you printed a vertical alignment sheet, press the arrow buttons to select the number representing the most solid printed pattern from the first row of your alignment sheet, and press the **OK** button. Repeat these steps for each printed row on your alignment sheet.

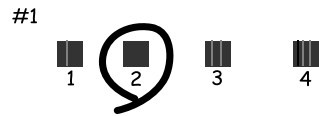

- If you printed a horizontal alignment sheet, press the arrow buttons to select the number representing the printed pattern with the least amount of separation or overlap, and press the **OK** button.



Parent topic: [Print Head Alignment](#)

Related tasks

[Loading Paper in the Cassette](#)

Aligning the Print Head Using a Computer Utility

You can align the print head using a utility on your Windows or Mac computer.

1. Load a few sheets of plain paper in the product.
2. Do one of the following:
 - **Windows:** Access the Windows Desktop and right-click the product icon in the Windows taskbar.
 - **OS X:** In the Apple menu or the Dock, select **System Preferences**. Select **Print & Fax**, **Print & Scan**, or **Printers & Scanners**, select your product, and select **Options & Supplies**. Select **Utility** and select **Open Printer Utility**.

3. Select **Print Head Alignment**.
4. Click **Next**, then click **Print** to print an alignment sheet.

Note: Do not cancel printing while you are printing a head alignment pattern.

You see a window like this:

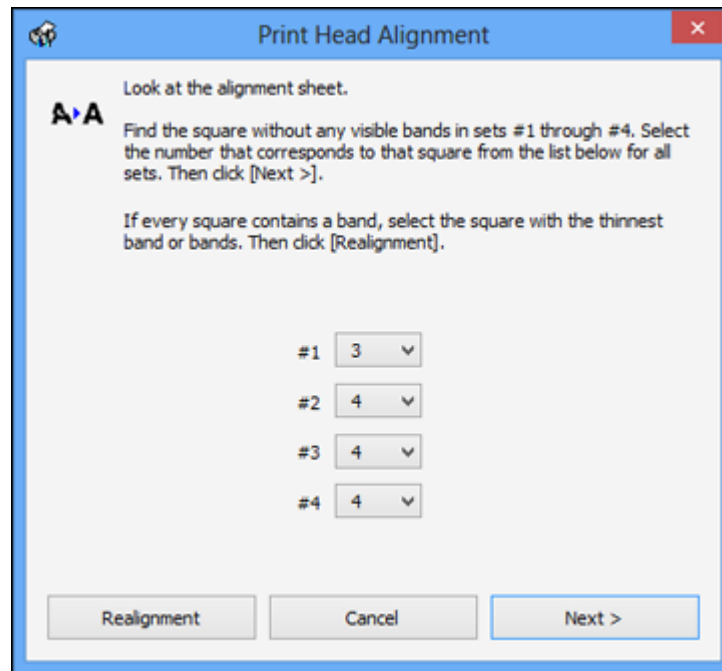

5. Check the printed pattern and follow the instructions on the screen to choose the number representing the best printed pattern for each set.

Vertical alignment

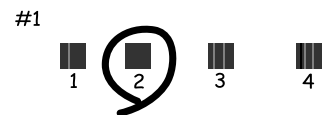

Horizontal alignment



- After choosing a pattern number, click **Next**.
- If no patterns are aligned in one or more of the sets, choose the closest one in each set and click **Realignment**. Then print another alignment sheet and check it.

Note: Click **Skip** (where available) if you want to skip a particular alignment sheet.

6. When you are done, click **Finish**.

Parent topic: [Print Head Alignment](#)

Related tasks

[Loading Paper in the Cassette](#)

Cleaning the Paper Path

If you see ink on the back of a printout, you can clean the paper path to remove any excess ink.

Caution: Do not use tissue paper to clean the rollers inside the product; lint from tissue paper may clog the print head nozzles.

1. Load a few sheets of plain paper in the product.
2. Press the up or down arrow button to select **Setup**.
3. Press the up or down arrow button to select **Maintenance**.
4. Press the up or down arrow button to select **Paper Guide Cleaning**.
5. Follow the on-screen instructions to clean the paper path.
6. Repeat as necessary until the paper comes out clean.

Parent topic: [Adjusting Print Quality](#)

Related tasks

[Loading Paper in the Cassette](#)

Checking the Number of Sheets

You can view an option that displays the number of sheets of paper that have fed through the product.

[Checking the Sheet Counter - Windows](#)

[Checking the Sheet Counter - OS X](#)

Parent topic: [Adjusting Print Quality](#)

Checking the Sheet Counter - Windows

You can check the number of sheets of paper that have fed through the product by checking the sheet counter.

1. Access the Windows Desktop and right-click the product icon in the Windows taskbar.
2. Select **Printer Settings**.
3. Click the **Maintenance** tab.
4. Select **Printer and Option Information**.

You see this window:

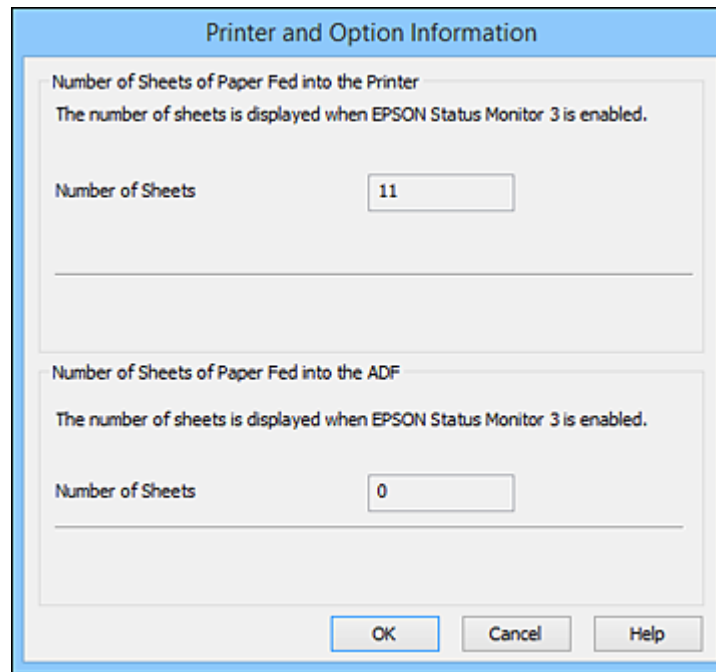

5. After checking the number of sheets fed into the printer, click **OK** to close the window.

Note: The number of sheets is displayed only when Epson Status Monitor 3 is enabled.

Parent topic: [Checking the Number of Sheets](#)

Checking the Sheet Counter - OS X

You can check the number of sheets of paper that have fed through the product by checking the sheet counter.

1. In the Apple menu or the Dock, select **System Preferences**. Select **Print & Fax**, **Print & Scan**, or **Printers & Scanners**, select your product, and select **Options & Supplies**. Select **Utility** and select **Open Printer Utility**.
2. Select **Printer and Option Information**.

You see this window:

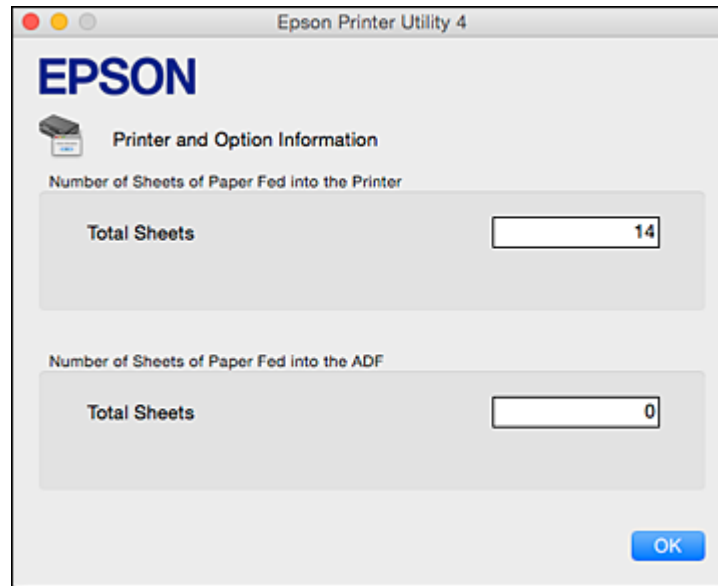

3. After checking the number of sheets fed into the printer, click **OK** to close the window.

Parent topic: [Checking the Number of Sheets](#)

Cleaning and Transporting Your Product

See these sections if you need to clean or transport your product.

[Cleaning Your Product](#)

[Transporting Your Product](#)

Cleaning Your Product

To keep your product working at its best, you should clean it several times a year.

Close the output tray and paper support when you are not using the product to protect it from dust.

Caution: Do not use a hard brush, alcohol, or paint thinner to clean the product or you may damage it. Do not use oil or other lubricants inside the product or let water get inside it.

1. Turn off the product.
2. Unplug the power cable.
3. Disconnect any connected cables.
4. Remove all the paper.

5. Clean the scanner glass with a soft, lint-free cloth (microfiber is recommended), moistened with a little glass cleaner. If you see lines in your scans or copies, clean the left side of the glass carefully.

Caution: Do not spray glass cleaner directly on the glass and do not press the glass surface with any force.

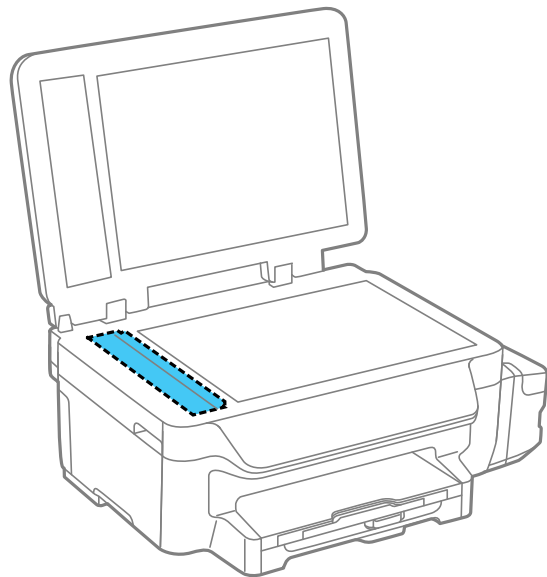

6. Open the ADF cover and use a soft, dry, lint-free cloth (microfiber is recommended) to clean the rollers and the interior of the ADF.

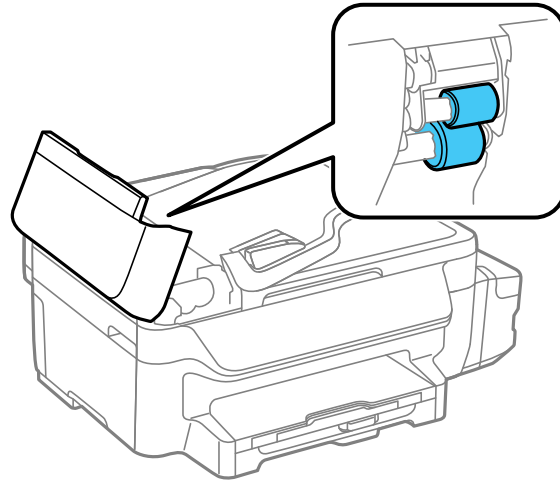

7. Clean the outer case and control panel with a soft, dry, lint-free cloth. Do not use liquid or chemical cleansers.

Parent topic: [Cleaning and Transporting Your Product](#)

Transporting Your Product

If you need to store your product or transport it some distance, prepare it for transportation as described here.

Caution: During transportation and storage, follow these guidelines:

- Avoid tilting the product, placing it vertically, or turning it upside down; otherwise ink may leak.
- When storing or transporting an ink bottle after removing its seal, do not tilt the bottle and do not subject it to impacts or temperature changes. Otherwise, ink may leak even if the cap on the ink bottle is tightened securely. Be sure to keep the ink bottle upright when tightening the cap, and take measures to prevent ink from leaking when transporting the ink bottles.

Note: Before storing your product for a long period, replace low, expended, or expired ink to help prevent the print head from drying out. Store your product in a cool, dry place.

1. Turn off the product.
2. Lift up the scanner unit and check to see if the print head is in the far right position (the home position). If not, turn on the product, wait for the print head to move to the far right, then turn the product off again.
3. Secure the print head to the case with tape.

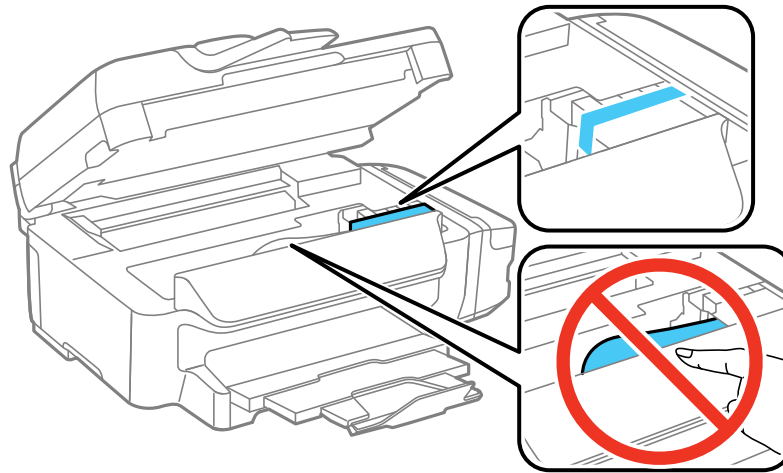

Caution: Do not place tape on the white flat cable inside the product; otherwise, you may damage your product.

4. Lower the scanner unit.
5. Remove all the paper from the product.

6. Close the output tray, if necessary.

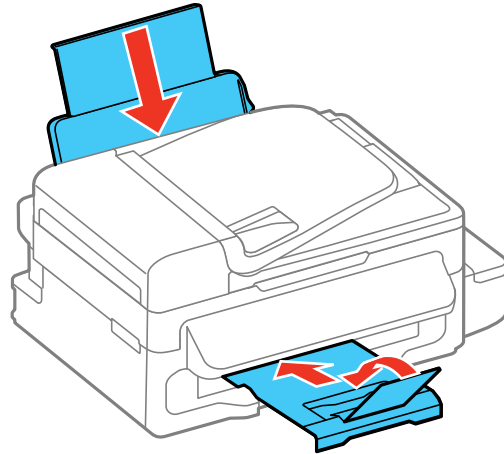

7. Unplug the power cable.
8. Disconnect any connected cables.
9. Open the ink tank unit cover and check to make sure that the ink tank caps are installed securely.

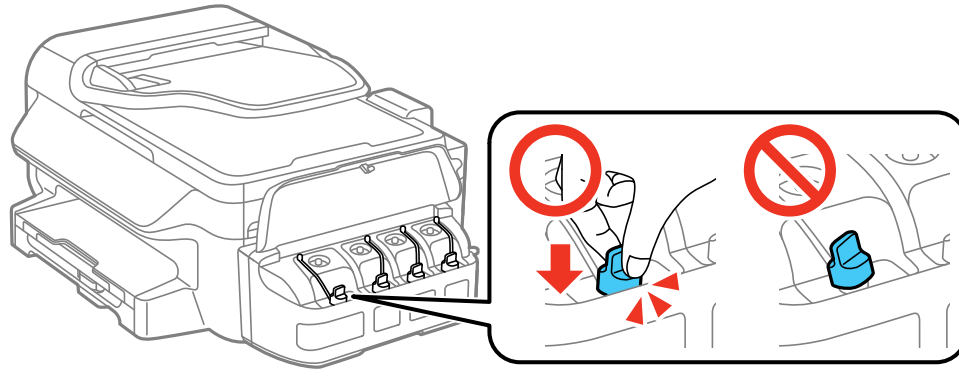

10. Place the product in the plastic bag that was included with the product and fold the bag closed as shown.

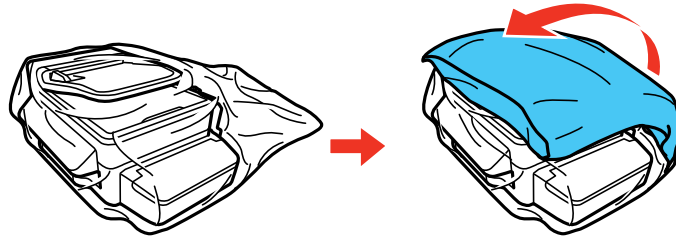

11. Place the product in its original packaging materials, if possible, or use equivalent cushioning around the product.

Caution:

- Keep the product level during transport. Otherwise, ink may leak.

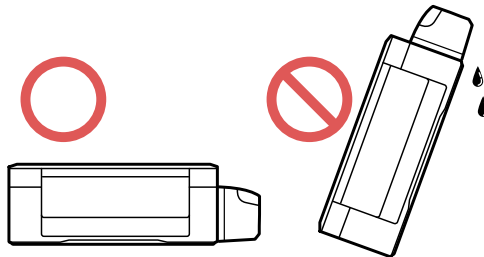

- Do not put opened ink bottles in the box with product.

If print quality has declined when you print again, clean and align the print head.

Parent topic: [Cleaning and Transporting Your Product](#)

Related concepts

[Print Head Cleaning](#)

[Print Head Alignment](#)

Solving Problems

Check these sections for solutions to problems you may have using your product.

[Checking for Software Updates](#)

[Product Status Messages](#)

[Running a Product Check](#)

[Resetting Control Panel Defaults](#)

[Solving Setup Problems](#)

[Solving Network Problems](#)

[Solving Copying Problems](#)

[Solving Paper Problems](#)

[Solving Problems Printing from a Computer](#)

[Solving Page Layout and Content Problems](#)

[Solving Print Quality Problems](#)

[Solving Scanning Problems](#)

[Solving Scanned Image Quality Problems](#)

[Solving Faxing Problems](#)

[Message Appears Prompting You to Reset Ink Levels](#)

[Uninstall Your Product Software](#)

[Where to Get Help](#)

Checking for Software Updates

Periodically, it's a good idea to check Epson's support website for free updates to your product software. You can select **Download the Latest Software** from the Home screen of this manual or visit Epson's driver download site ([U.S. downloads](#) or [Canadian downloads](#)).

- **Windows:** Your printer software automatically checks for updates. You can also manually update the software by selecting **Software Update** here:

- Accessing the Windows Desktop and right-clicking the product icon in the Windows taskbar
- On the **Maintenance** tab in the printer settings window

You can also update the software by selecting **EPSON Software Updater** in the **EPSON** or **EPSON Software** program group, accessible by the **Start** button, or on the **Start** or **Apps** screens, depending on your version of Windows.

- **OS X:** You can manually update the software by opening the **Applications > Epson Software** folder and selecting **EPSON Software Updater**.

Parent topic: [Solving Problems](#)

Product Status Messages

You can often diagnose problems with your product by checking the messages on its LCD screen.

LCD screen message	Condition/solution
Printer error 0xXX	Turn off the product, make sure no paper is jammed, then turn it back on again. If the error continues, contact Epson for support.
A printer's ink pad is nearing the end of its service life.	The ink pad is near the end of its service life, contact Epson for support. (To continue printing, press one of the Start buttons.)
A printer's ink pad is at the end of its service life.	The ink pad is at the end of its service life. Turn off the product and contact Epson for support.
Communication error	Make sure the computer is connected to your product and your software is installed correctly.
Paper jam	Paper is jammed in the product. Remove the jammed paper and press the OK button to clear the error.
Invalid IP address and subnet mask	Enter the IP address and subnet mask correctly.
No dial tone	Make sure the phone cable is connected correctly and the phone line works. If you connected the product to a PBX (Private Branch Exchange) phone line or Terminal Adapter, turn off the Dial Tone Detection setting.
Recovery mode	An error has occurred during firmware updating. Connect your product using a USB cable and try updating the firmware again. If you still receive this error message, contact Epson for support.

Note: The ink pads in the printer collect, distribute, and contain the ink that is not used on printed pages. During the life of your product it may reach a condition where either satisfactory print quality cannot be maintained or the ink pads have reached the end of their usable life. The Epson Status Monitor, your LCD screen, or lights on the control panel will advise you when these parts need replacing. If this happens during the standard warranty of the product, the exchange of the product or replacement of the pads is covered under the standard warranty. If the product is out of warranty, the pads can be replaced by any Epson authorized service provider. The waste ink pads are not a user-replaceable part.

Parent topic: [Solving Problems](#)

Related references

[Where to Get Help](#)

Related tasks

[Checking for Software Updates](#)

[Connecting a Telephone or Answering Machine](#)

Related topics

[Loading Paper](#)

[Wi-Fi or Wired Networking](#)

[Solving Paper Problems](#)

Running a Product Check

Running a product check helps you determine if your product is operating properly.

1. Disconnect any interface cables connected to your product.
2. Load a few sheets of plain paper in the product.
3. Press the up or down arrow button, select **Setup**, and press the **OK** button.

You see this screen:

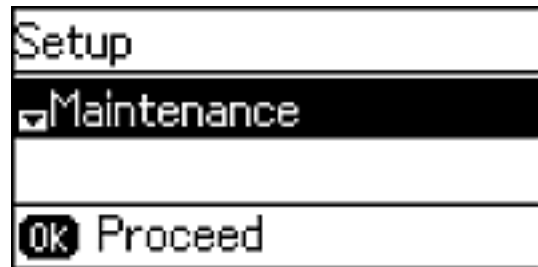

4. Press the up or down arrow button, select **Maintenance**, and press the **OK** button.
5. Press the up or down arrow button, to select **Print Head Nozzle Check**, and press the **OK** button.
6. Press one of the **Start** buttons.

7. Do the following, depending on the results of the product check:
 - If the page prints and the nozzle check pattern is complete, the product is operating properly. Any operation problem you may have could be caused by your computer, cable, software, or selected settings. Check the other available solutions or try uninstalling and reinstalling your printer software.
 - If the page prints but the nozzle check pattern has gaps, clean or align the print head.
 - If the page does not print, the product may have a problem. Check the other solutions in this manual. If they do not work, contact Epson.

Parent topic: [Solving Problems](#)

Related concepts

[Print Head Cleaning](#)

[Print Head Alignment](#)

[Uninstall Your Product Software](#)

Related references

[Where to Get Help](#)

Resetting Control Panel Defaults

If you have a problem with settings on the product control panel, you can reset them to their factory defaults. You can choose which settings to reset or reset them all.

1. Press the up or down arrow button, select **Setup**, and press the **OK** button.
2. Press the up or down arrow button, select **Restore Default Settings**, and press the **OK** button.

You see this screen:

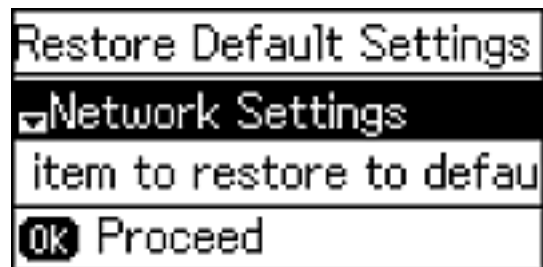

3. Press the up or down arrow button to select one of these options and press the **OK** button.
 - **Network Settings:** Restores all of the default network settings.
 - **Fax Settings:** Restores all of the fax settings.
 - **Clear All Data and Settings:** Restores all of the default settings and resets contact and network data on the control panel.You see a confirmation screen.
4. Press the up arrow button to reset the selected settings. Press the down arrow button if you want to cancel the operation.

Parent topic: [Solving Problems](#)

Solving Setup Problems

Check these sections if you have problems while setting up your product.

[Noise After Filling the Ink](#)

[Software Installation Problems](#)

[Control Panel Setup Problems](#)

[USB Connection Problems](#)

Parent topic: [Solving Problems](#)

Noise After Filling the Ink

If you hear noises from your product after filling the ink tanks with ink, check these explanations:

- The first time you fill the tanks with ink, the product must charge its print head. Wait until charging finishes before you turn off the product, or it may charge improperly and use excess ink the next time you turn it on.
- If the product's print head stops moving or making noise, and the charging process has not finished after approximately 20 minutes, turn off your product. Turn it back on and check to see if charging is still in progress. If it is still in progress, contact Epson for help.

Parent topic: [Solving Setup Problems](#)

Software Installation Problems

If you have problems while installing your product software, try these solutions:

- Make sure your product is turned on and any necessary cables are securely connected at both ends. If you still have problems installing software, disconnect the cable and carefully follow the instructions on the *Start Here* sheet. Also make sure your system meets the requirements for your operating system.
- Close any other programs, including screen savers and virus protection software, and install your product software again.
- In Windows, make sure your product is selected as the default printer and the correct port is shown in the printer properties.
- If you see any error message or your software does not install correctly in Windows, you may not have software installation privileges. Contact your System Administrator.

Parent topic: [Solving Setup Problems](#)

Related concepts

[Uninstall Your Product Software](#)

Related references

[Windows System Requirements](#)

[OS X System Requirements](#)

Control Panel Setup Problems

If you have problems setting up the control panel, try these solutions:

- To view LCD screen text in a different language, select a different language setting for the panel.
- To turn off the beep heard when you press a button, turn off the panel's sound setting. This also turns off the dialing sound for sending faxes.

Parent topic: [Solving Setup Problems](#)

Related tasks

[Changing LCD Screen Language](#)

[Turning Off Control Panel Sounds](#)

USB Connection Problems

If you used a USB cable to connect to a computer that has multiple peripherals, make sure the computer is grounded. Otherwise, you may feel a slight electric shock when touching your product.

Parent topic: [Solving Setup Problems](#)

Solving Network Problems

Check these solutions if you have problems setting up or using your product on a network.

Note: Breakdown or repair of this product may cause loss of fax and network data and settings. Epson is not responsible for backing up or recovering data and settings during or after the warranty period. We recommend that you make your own backup or print out your fax and network data and settings.

[Product Cannot Connect to a Wireless Router or Access Point](#)

[Cannot Print Over a Network](#)

[Network Software Cannot Find Product on a Network](#)

[Product Does Not Appear in OS X Printer Window](#)

[Cannot Print Over a Network](#)

[Cannot Scan Over a Network](#)

Parent topic: [Solving Problems](#)

Product Cannot Connect to a Wireless Router or Access Point

If your product has trouble finding or connecting to a wireless router or access point, try these solutions:

- If you are connecting the product via Wi-Fi Protected Setup (WPS) and the Wi-Fi icon on your product's LCD screen is not lit or does not appear, make sure you select one of the WPS options from the product control panel within 2 minutes of pressing the WPS button on your router.
- Make sure to place your product within contact range of your 2.4 GHz router or access point. Avoid placing your product near a microwave oven, 2.4 GHz cordless phone, or large metal object, such as a filing cabinet.

Note: If you are using a 5 GHz wireless router, set the router to operate in dual band (2.4 GHz and 5 GHz) mode. See your router documentation for instructions.

- Verify that your router or access point is operating correctly by connecting to it from your computer or another device.
- You may need to disable the firewall and any anti-virus software on your wireless router or access point.
- Check to see if access restrictions, such as MAC address filtering, are set on the router or access point. If access restrictions are set, add your product's MAC address to your router's address list. To obtain your product's MAC address, print a network status sheet. Then follow the instructions in your router or access point documentation to add the address to the list.

- If your router or access point does not broadcast its network name (SSID), follow the instructions that came with your product to enter your wireless network name manually.
- If your router or access point has security enabled, determine the kind of security it is using and any required password or passphrase for connection. Then make sure to enter the exact WEP key or WPA passphrase correctly.
- Check if your computer is restricting the available wireless channels. If so, verify that your wireless access point is using one of the usable channels and change to a usable channel, if necessary.
- If you are using a Wi-Fi Direct connection that suddenly disconnects, the Wi-Fi direct password on your device may have been changed. If necessary, delete the existing **DIRECT-xxxxxxx** connection settings from your device and enter a new password. See your device documentation for instructions.
- If you connected your product to a Windows computer using Wi-Fi Direct and it automatically selected Access Point Mode, you may have trouble accessing a low-priority Internet connection. Check the network connection or adapter settings in the Windows Control Panel and set the **Internet metric** setting to **100** for your version of the Internet Protocol.

Parent topic: [Solving Network Problems](#)

Related concepts

[Wi-Fi Direct Mode Setup](#)

Related tasks

[Selecting Wireless Network Settings From the Control Panel](#)

[Printing a Network Status Sheet](#)

Related topics

[Wi-Fi or Wired Networking](#)

Cannot Print Over a Network

If you cannot print over a network, try these solutions:

- Make sure that your product is turned on.
- Make sure you install your product's network software as described in your product documentation.
- Print a network status sheet and verify that the network settings are correct. If the network status is **Disconnected**, check any cable connections and turn your product off and then on again.
- If you are using TCP/IP, make sure the product's IP address is set correctly for your network. If your network does not assign IP addresses using DHCP, set the IP address manually.
- Make sure your computer and product are both using the same wireless network.

- If network printing is slow, print a network status sheet and check the signal strength. If it is poor, place your product closer to your router or access point. Avoid placing your product near a microwave oven, 2.4 GHz cordless phone, or large metal object, such as a filing cabinet.

Note: If you are using a 5 GHz wireless router, set the router to operate in dual band (2.4 GHz and 5 GHz) mode. See your router documentation for instructions.

- Check to see if your wireless router or access point has an enabled Privacy Separator function that is preventing printing from a device over the network. See your router or access point documentation for instructions on disabling the Privacy Separator function.
- If you are connecting the product via Wi-Fi Protected Setup (WPS) and the Wi-Fi icon does not appear on your product's LCD screen, make sure you select one of the WPS options from the product control panel within 2 minutes of pressing the WPS button on your router.
- Check your wired LAN router or access point to see if the LED for the port to which your product is connected is on or flashing. If the link LED is off, try the following:
 - Make sure the Ethernet cable is securely connected to your product and to your router, access point, switch, or hub.
 - Try connecting your product to a different port or a different router, access point, switch, or hub.
 - Try connecting with a different Ethernet cable.
 - Try printing to your product from another computer on the network.

Note: If you are using a 5 GHz wireless router, set the router to operate in dual band (2.4 GHz and 5 GHz) mode. See your router documentation for instructions.

- If you are connecting the product via EpsonNet Setup and the Wi-Fi icon does not appear on the LCD, make sure your product software was installed correctly. If necessary, reinstall your software.

Parent topic: [Solving Network Problems](#)

Network Software Cannot Find Product on a Network

If EpsonNet Setup cannot find your product on a network, try these solutions:

- Make sure your product is turned on and connected to your network. Verify connection using your product control panel.
- Check if your network name (SSID) contains non-ASCII characters. Your product cannot display non-ASCII characters.
- Make sure your product is not connected to a guest network.

- If necessary, reinstall your product software and try running EpsonNet Setup again:
 1. Reset your product's network settings to their factory defaults.
 2. Windows only: uninstall your product software.
 3. Initialize your router following the instructions in your router documentation.

Note: If you are reading these instructions online, you will lose your Internet connection when you initialize your router, so note the next step before initializing it.

4. Download your product software from the Epson website using the instructions on the *Start Here* sheet.
- If you have replaced your router, reinstall your product software to connect to the new router.

Note: If you are using a 5 GHz wireless router, set the router to operate in dual band (2.4 GHz and 5 GHz) mode. See your router documentation for instructions.

Parent topic: [Solving Network Problems](#)

Related concepts

[Uninstall Your Product Software](#)

Related topics

[Wi-Fi or Wired Networking](#)

Product Does Not Appear in OS X Printer Window

If your product does not appear in the OS X printer window, try these solutions:

- Turn your product off, wait 30 seconds, then turn it back on again.
- If you are connecting the product via Wi-Fi Protected Setup (WPS) and the Wi-Fi icon does not appear on your product's LCD screen, make sure you select one of the WPS options from the product control panel within 2 minutes of pressing the WPS button on your router.
- If you are connecting the product wirelessly via EpsonNet Setup and the Wi-Fi icon does not appear on your LCD screen, make sure your product software was installed correctly. If necessary, reinstall your software.

Note: If you are using a 5 GHz wireless router, set the router to operate in dual band (2.4 GHz and 5 GHz) mode. See your router documentation for instructions.

Parent topic: [Solving Network Problems](#)

Related concepts

[Uninstall Your Product Software](#)

Cannot Print Over a Network

If you cannot print over a network, try these solutions:

- Make sure that your product is turned on.
- Make sure you install your product's network software as described in your product documentation.
- Print a network status sheet and verify that the network settings are correct. If the network status is **Disconnected**, check any cable connections and turn your product off and then on again.
- If you are using TCP/IP, make sure the product's IP address is set correctly for your network. If your network does not assign IP addresses using DHCP, set the IP address manually.
- Make sure your computer and product are both using the same wireless network.
- If network printing is slow, print a network status sheet and check the signal strength. If it is poor, place your product closer to your router or access point. Avoid placing your product near a microwave oven, 2.4 GHz cordless phone, or large metal object, such as a filing cabinet.

Note: If you are using a 5 GHz wireless router, set the router to operate in dual band (2.4 GHz and 5 GHz) mode. See your router documentation for instructions.

- Check to see if your wireless router or access point has an enabled Privacy Separator function that is preventing printing from a device over the network. See your router or access point documentation for instructions on disabling the Privacy Separator function.

Parent topic: [Solving Network Problems](#)

Related references

[Cannot Scan Over a Network](#)

Related tasks

[Printing a Network Status Sheet](#)

Related topics

[Wi-Fi or Wired Networking](#)

Cannot Scan Over a Network

If you cannot start Epson Scan for scanning over a network, try these solutions:

- If you cannot scan from your product control panel, make sure you restarted your computer after installing the product software. Make sure the Event Manager program is not being blocked by your firewall or security software.

Note: If you are using a 5 GHz wireless router, set the router to operate in dual band (2.4 GHz and 5 GHz) mode. See your router documentation for instructions.

- If you are scanning a large original at a high resolution, a network communication error may occur. Try scanning again at a lower resolution.
- If network communication was interrupted while starting Epson Scan, exit Epson Scan, wait a few seconds, and restart it. If Epson Scan cannot restart, turn off your product, turn it back on, and try restarting Epson Scan again.
- Check the connection setting and test the connection using Epson Scan Settings:

Windows 8.x: Navigate to the **Apps** screen and select **EPSON Scan Settings**. Make sure the **Connection** setting is set to **Network**, then click the **Test** button.

Windows (other versions): Click  or **Start > All Programs** or **Programs > EPSON > EPSON Scan > EPSON Scan Settings**. Make sure the **Connection** setting is set to **Network**, then click the **Test** button.

OS X: Open the **Applications** folder, click **Epson Software**, and click **EPSON Scan Settings**. Make sure the **Connection** setting is set to **Network**, then click the **Test** button.

- Make sure the option selected as the **Timeout Setting** in the Epson Scan Settings program is long enough to complete scanning over a network.
- You may need to disable the firewall and any anti-virus software on your wireless router or access point.

Note: With OS X, in addition to scanning with Image Capture, you can download and install Epson Scan scanning software. Epson Scan provides additional image adjustment and photo correction features for enhancing scanned images, and provides an interface for TWAIN-compliant OCR scanning software. To download Epson Scan, visit Epson's driver download site ([U.S. downloads](#) or [Canadian downloads](#)).

Parent topic: [Solving Network Problems](#)

Related tasks

[Starting a Scan Using the Product Control Panel](#)

[Starting a Scan Using the Epson Scan Icon](#)

Solving Copying Problems

Check these solutions if you have problems copying with your product.

[Product Makes Noise, But Nothing Copies](#)

[Product Makes Noise When It Sits for a While](#)

Parent topic: [Solving Problems](#)

Product Makes Noise, But Nothing Copies

If your product makes a noise, but nothing copies, try these solutions:

- Run a nozzle check to see if any of the print head nozzles are clogged. Then clean the print head, if necessary.
- If the nozzle check page does not print, but the product's power is on, make sure your product software is installed correctly.
- Make sure your product is level (not tilted).

Parent topic: [Solving Copying Problems](#)

Related concepts

[Print Head Nozzle Check](#)

[Print Head Cleaning](#)

Product Makes Noise When It Sits for a While

Your product is performing routine maintenance. This is normal.

Parent topic: [Solving Copying Problems](#)

Solving Paper Problems

Check these sections if you have problems using paper with your product.

[Paper Feeding Problems](#)

[Paper Jam Problems Inside the Product](#)

[Paper Jam Problems in the Paper Cassette](#)

[Paper Jam Problems in the Duplexer \(Rear Cover\)](#)

[Document Jams in the Automatic Document Feeder](#)

[Paper Ejection Problems](#)

Parent topic: [Solving Problems](#)

Paper Feeding Problems

If you have problems feeding paper, try these solutions:

- If paper does not feed for printing, remove it. Then reload it in the sheet feeder against the right side and beneath the tab. Slide the edge guide against the edge of the paper, making sure that the paper stack is not above the arrow mark on the edge guide.
- If multiple pages feed at once, remove the paper, fan the edges to separate the sheets, and reload it.
- If paper jams when you load only one or two sheets, try loading more sheets at a time. Do not load more than the recommended number of sheets.
- If paper jams when you print on both sides of the paper, try loading fewer sheets.
- Make sure your paper meets the specifications for your product.
- For best results, follow these guidelines:
 - Use new, smooth, high-quality paper that is not curled, creased, old, too thin, or too thick.
 - Load paper in the sheet feeder printable side up.
 - Follow any special loading instructions that came with the paper.

Parent topic: [Solving Paper Problems](#)

Related references

[Paper Jam Problems Inside the Product](#)

[Paper Jam Problems in the Paper Cassette](#)

[Paper Jam Problems in the Duplexer \(Rear Cover\)](#)

[Document Jams in the Automatic Document Feeder](#)

[Paper Loading Capacity](#)

Related tasks

[Loading Paper in the Cassette](#)

Paper Jam Problems Inside the Product

If paper has jammed inside the product, follow the steps here to clear the jam.

1. Cancel the print job, if necessary.

2. Lift the scanner unit.

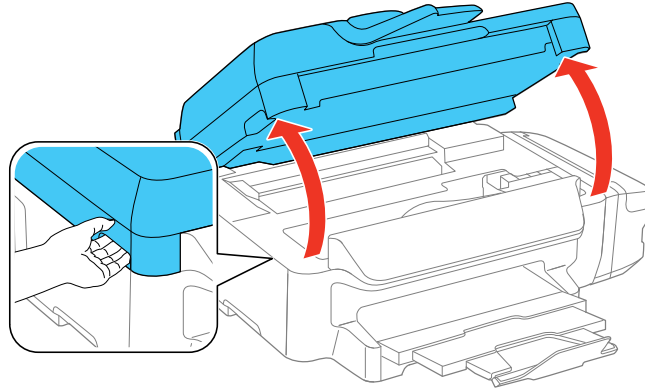

Caution: Do not touch the flat white cable inside the printer. Do not lift the scanner unit while the document cover is open.

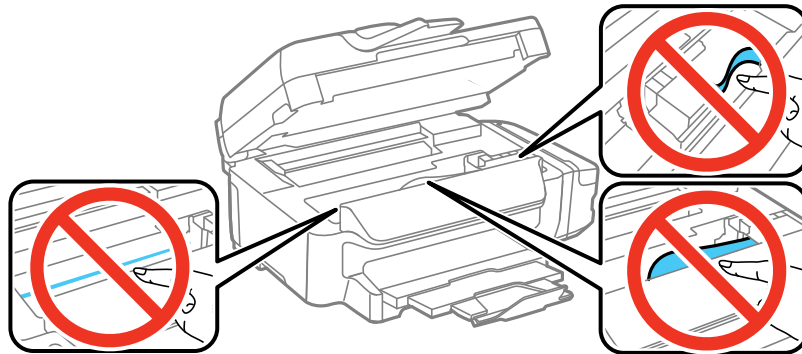

3. Remove any paper inside, including torn pieces.

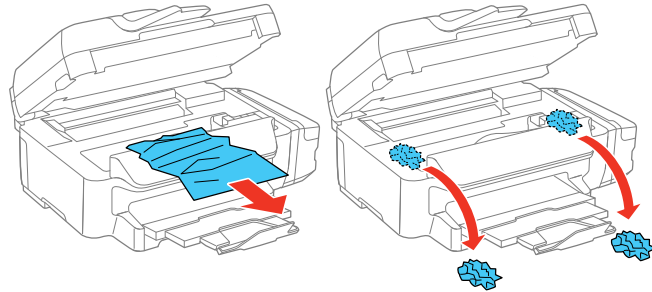

4. Close the scanner unit.
5. Follow the prompts on the LCD screen to clear any error messages. If you still see a paper jam message, check the other paper jam solutions.

Parent topic: [Solving Paper Problems](#)

Related references

[Paper Jam Problems in the Paper Cassette](#)

[Paper Jam Problems in the Duplexer \(Rear Cover\)](#)

[Document Jams in the Automatic Document Feeder](#)

Paper Jam Problems in the Paper Cassette

If paper has jammed in a paper cassette, follow the steps here to clear the jam.

1. Cancel the print job, if necessary.

2. Pull out the paper cassette.

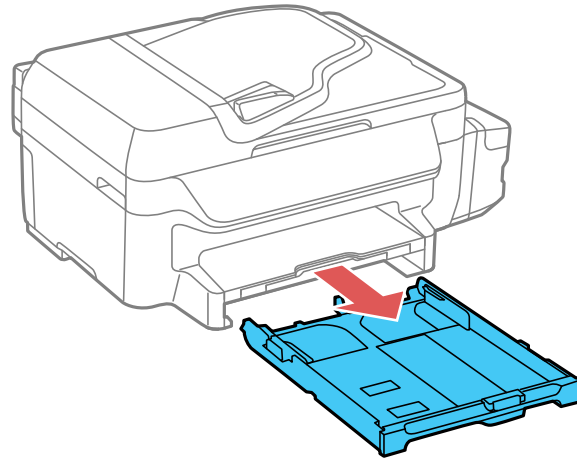

3. Carefully remove any paper jammed inside the product.

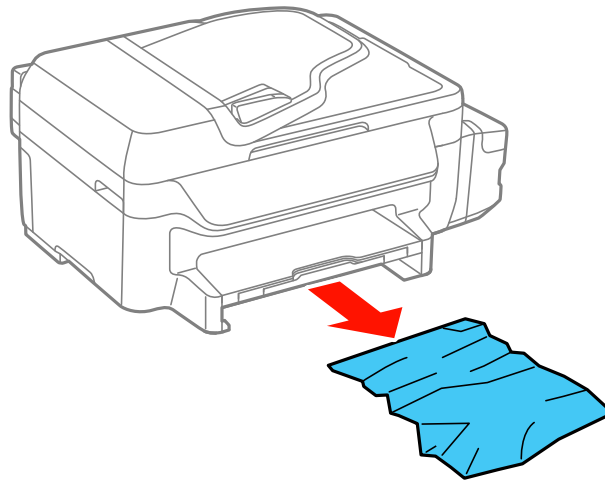

4. Gently insert the paper cassette.

5. Follow the prompts on the LCD screen to clear any error messages. If you still see a paper jam message, check the other paper jam solutions.

Parent topic: [Solving Paper Problems](#)

Related references

[Paper Jam Problems Inside the Product](#)

[Paper Jam Problems in the Duplexer \(Rear Cover\)](#)

[Document Jams in the Automatic Document Feeder](#)

Paper Jam Problems in the Duplexer (Rear Cover)

If paper has jammed in the duplexer (rear cover), follow the steps here to clear the jam.

1. Cancel the print job, if necessary.
2. Press the tabs and remove the duplexer.

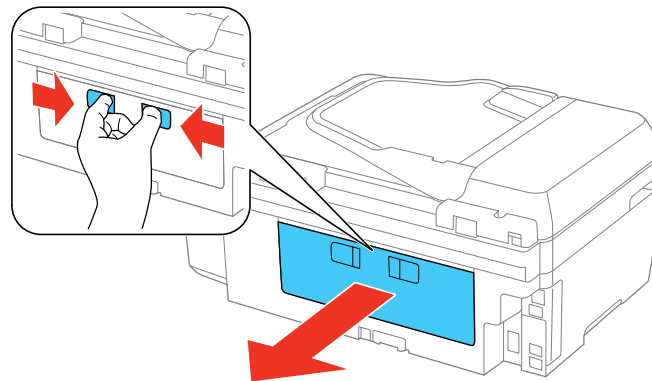

3. Carefully remove any jammed paper.

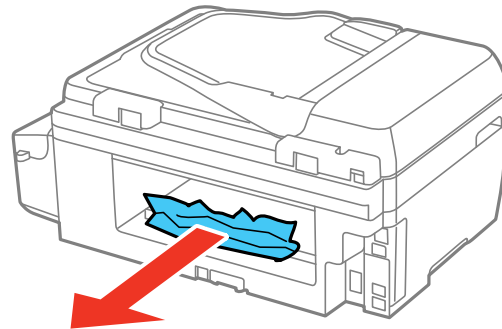

4. Remove any jammed paper from the duplexer.

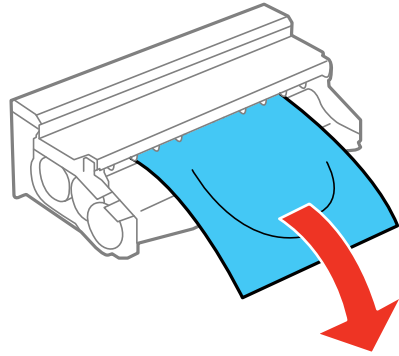

5. Open the duplexer and carefully remove any jammed paper stuck inside.

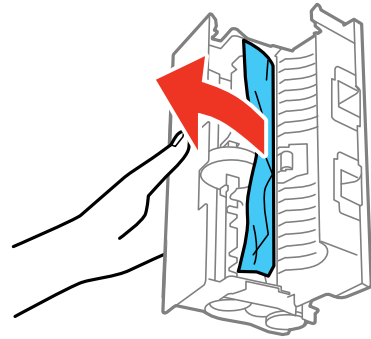

6. Reattach the duplexer.

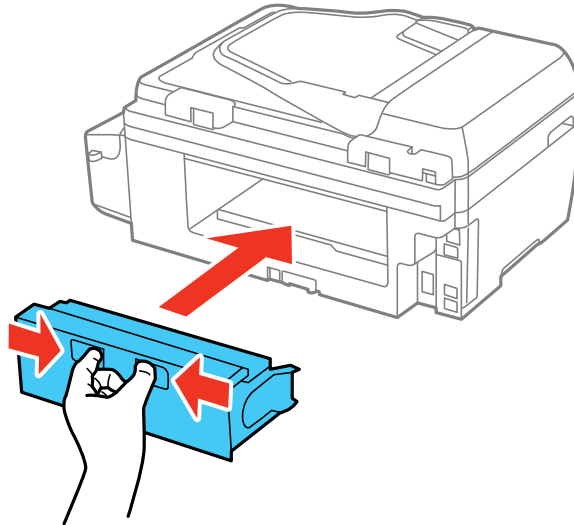

7. Follow the prompts on the LCD screen to clear any error messages. If you still see a paper jam message, check the other paper jam solutions.

Parent topic: [Solving Paper Problems](#)

Related references

[Paper Jam Problems Inside the Product](#)

[Paper Jam Problems in the Paper Cassette](#)

[Document Jams in the Automatic Document Feeder](#)

Document Jams in the Automatic Document Feeder

If you have problems with document jams in the automatic document feeder (ADF), follow the steps here to clear the jam.

1. Cancel the print job, if necessary.
2. Remove your originals from the ADF.

3. Open the ADF cover.

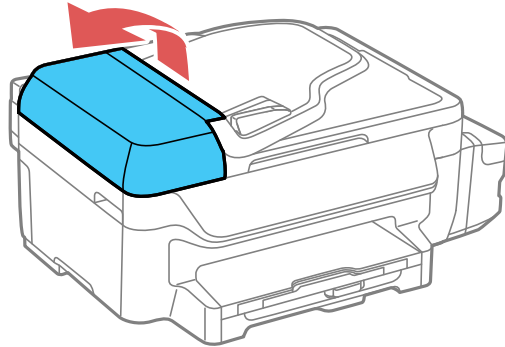

Caution: Make sure you open the ADF cover before removing any jammed pages. Otherwise the product may be damaged.

4. Carefully remove any jammed pages.

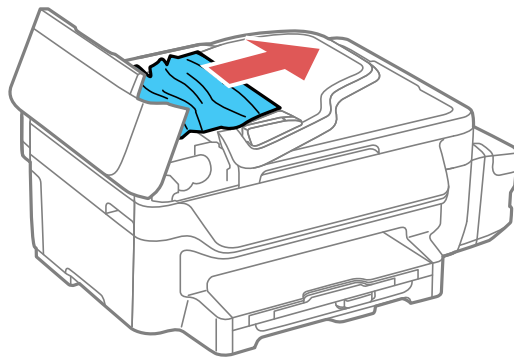

5. Close the ADF cover, then open the document cover.

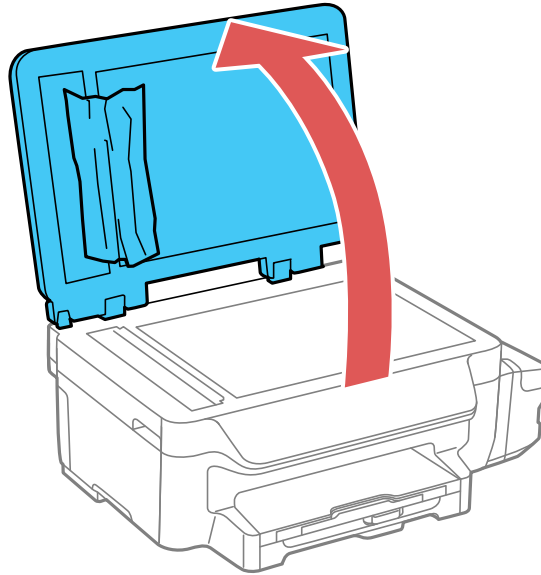

6. Carefully remove any jammed pages in the direction shown.

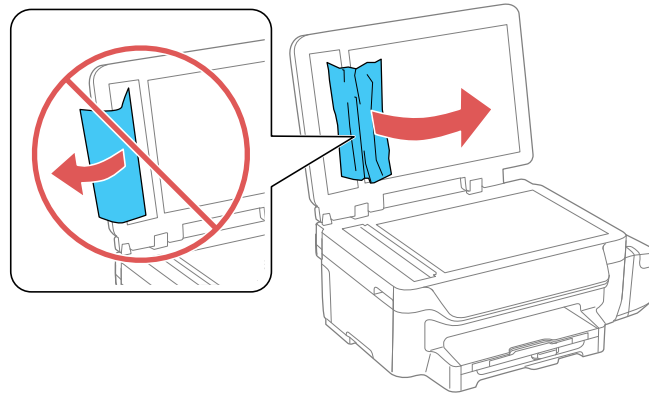

7. Close the document cover.

8. Raise the ADF input tray and carefully remove any jammed pages.

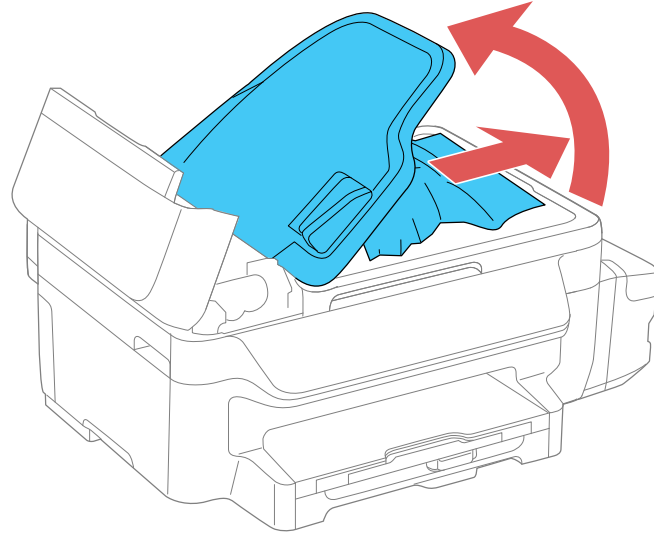

9. Lower the ADF input tray to its original position.
10. Reload your originals.

Caution: Make sure you do not load the ADF beyond its capacity for your paper size. Also make sure your originals are not bent, folded, or curled and do not have tape, staples, or other materials that could obstruct the feeder.

11. Follow the prompts on the LCD screen to clear any error messages. If you still see a paper jam message, check the other paper jam solutions.

Parent topic: [Solving Paper Problems](#)

Related references

[Paper Jam Problems Inside the Product](#)

[Paper Jam Problems in the Paper Cassette](#)

[Paper Jam Problems in the Duplexer \(Rear Cover\)](#)

Paper Ejection Problems

If you have problems with paper ejecting properly, try these solutions:

- If paper does not eject fully, you may have set the wrong paper size. Cancel printing to eject the paper. Select the correct paper size when you reprint.
- If paper is wrinkled when it ejects, it may be damp or too thin. Load new paper and be sure to select the correct paper type setting when you reprint.

Parent topic: [Solving Paper Problems](#)

Related references

[Paper Jam Problems Inside the Product](#)

[Paper Jam Problems in the Paper Cassette](#)

[Paper Jam Problems in the Duplexer \(Rear Cover\)](#)

[Document Jams in the Automatic Document Feeder](#)

[Paper or Media Type Settings - Product Software](#)

[Paper Type Settings - Control Panel](#)

Related tasks

[Cancelling Printing Using a Product Button](#)

Related topics

[Loading Paper](#)

Solving Problems Printing from a Computer

Check these sections if you have problems while printing from your computer.

Note: When printing using AirPrint, the available print settings are different from those covered in this manual. See the Apple website for details.

[Nothing Prints](#)

[Product Icon Does Not Appear in Windows Taskbar](#)

[Printing is Slow](#)

Parent topic: [Solving Problems](#)

Nothing Prints

If you have sent a print job and nothing prints, try these solutions:

- Make sure your product is turned on.
- Make sure any interface cables are connected securely at both ends.
- If you connected your product to a USB hub, make sure it is a first-tier hub. If it still does not print, connect your product directly to your computer instead of the hub.
- Run a product check to see if a test page prints. If the test page prints, check to see if your product software is installed correctly.
- If you are printing a large image, the computer may not have enough memory. Print the image at a lower resolution or a smaller file size.
- In Windows, click **Print Queue** on the Maintenance tab in the printer settings window and check for the following:
 - Check for any stalled or paused print jobs. Cancel or unpause any jobs as necessary.
 - Open the Printer menu and make sure the product is not offline.
 - Open the Printer menu and set the product as the default printer, if necessary.
- In OS X, select **System Preferences** from the Apple menu or Dock, select **Print & Scan** or **Printers & Scanners**, then double-click your printer icon. Check to see if any jobs are paused. Cancel or resume any jobs as necessary.



Parent topic: [Solving Problems Printing from a Computer](#)

Related tasks

[Running a Product Check](#)

Product Icon Does Not Appear in Windows Taskbar

If you do not see your product icon in the Windows taskbar, first try restarting your computer. If that does not work, try this solution:

1. Do one of the following:
 - **Windows 8.x:** Navigate to the **Apps** screen and select **Control Panel > Hardware and Sound > Devices and Printers**.
 - **Windows 7:** Click  and select **Devices and Printers**.
 - **Windows Vista:** Click , select **Control Panel**, and click **Printer** under **Hardware and Sound**.

- **Windows XP:** Click **Start** and select **Printers and Faxes**. (Or open the **Control Panel**, select **Printers and Other Hardware**, if necessary, and **Printers and Faxes**.)
2. Right-click your product name, select **Printing Preferences**, and select your product name again if necessary.
 3. Click the **Maintenance** tab.
 4. Click the **Extended Settings** button.
 5. Select **Enable EPSON Status Monitor 3**, then click **OK**.
 6. Click the **Monitoring Preferences** button.
 7. Click the checkbox for the option that adds the shortcut icon to the taskbar.
 8. Click **OK** to close the open program windows.

Parent topic: [Solving Problems Printing from a Computer](#)

Printing is Slow

If printing becomes slow, try these solutions:

- Make sure your system meets the requirements for your operating system. If you are printing a high-resolution image, you may need more than the minimum requirements. If necessary, increase your system's memory.
- If you are using Windows 7, close the **Devices and Printers** window before you print.
- If you are using OS X, make sure you download and install the Epson printer driver.
- Make sure **Quiet Mode** is turned off.
- Clear space on your hard drive or run a defragmentation utility to free up existing space.
- Close any programs you are not using when you print.
- If your product is connected to a USB hub, connect it directly to your computer instead.
- If printing becomes slower after printing continuously for a long time, the product may have automatically slowed down to protect the print mechanism from overheating or becoming damaged. Let the product rest with the power on for 30 minutes, then try printing again.

For the fastest printing, select the following settings in your product software:

- Make sure the paper type setting matches the type of paper you loaded.
- Turn on any high speed settings in your product software.
- Select a lower print quality setting.

- Make sure the ink drying time has not been increased for double-sided printing.
- **Windows:** Click the **Maintenance** or **Utility** tab, select **Extended Settings** or **Speed and Progress**, and select the following settings:
 - **Always Spool RAW Datatype**
 - **Page Rendering Mode**
 - **Print as Bitmap**

Parent topic: [Solving Problems Printing from a Computer](#)

Related references

[Windows System Requirements](#)

[OS X System Requirements](#)

[Paper or Media Type Settings - Product Software](#)

Related tasks

[Selecting Basic Print Settings - Windows](#)

[Selecting Extended Settings - Windows](#)

[Selecting Basic Print Settings - OS X](#)

[Selecting Printing Preferences - OS X](#)

Solving Page Layout and Content Problems

Check these sections if you have problems with the layout or content of your printed pages.

Note: When printing using AirPrint, the available print settings are different from those covered in this manual. See the Apple website for details.

[Inverted Image](#)

[Too Many Copies Print](#)

[Blank Pages Print](#)

[Incorrect Margins on Printout](#)

[Incorrect Characters Print](#)

[Incorrect Image Size or Position](#)

[Slanted Printout](#)

Parent topic: [Solving Problems](#)

Inverted Image

If your printed image is inverted unexpectedly, try these solutions:

- Turn off any mirror or inversion settings in your printing application.
- Turn off the **Mirror Image**, **Flip horizontally**, or **Reverse page orientation** settings in your printer software. (This option has different names, depending on your operating system version.)

Note: Leave these options turned on when you print on Epson Iron-on Cool Peel Transfer paper, if available for your product.

Parent topic: [Solving Page Layout and Content Problems](#)

Related tasks

[Selecting Additional Layout and Print Options - Windows](#)

[Selecting Basic Print Settings - OS X](#)

Too Many Copies Print

Make sure that the **Copies** setting in your printing program or printer software is not set for multiple copies.

Parent topic: [Solving Page Layout and Content Problems](#)

Blank Pages Print

If blank pages print unexpectedly, try these solutions:

- Make sure you selected the correct paper size settings in your printing program and printer software.
- If a blank page exists in a document you are printing and you want to skip printing it, select the **Skip Blank Page** setting in your printer software.
- Run a print head nozzle check to see if any of the nozzles are clogged. Then clean the print head, if necessary.
- Make sure your product is selected as the printer in your printing program.
- You may need to refill the ink. Visually check the ink levels.

Parent topic: [Solving Page Layout and Content Problems](#)

Related concepts

[Print Head Nozzle Check](#)

[Print Head Cleaning](#)

Related tasks

[Selecting Basic Print Settings - Windows](#)

[Selecting Extended Settings - Windows](#)

[Selecting Basic Print Settings - OS X](#)

[Selecting Printing Preferences - OS X](#)

Incorrect Margins on Printout

If your printed page has incorrect margins, try these solutions:

- Make sure you selected the correct paper size settings in your printing program and printer software.
- Make sure you selected the correct margins for your paper size in your printing program.
- Make sure your paper is positioned correctly for feeding into the printer.

You can use the preview option in your printer software to check your margins before you print.

Parent topic: [Solving Page Layout and Content Problems](#)

Related tasks

[Selecting Basic Print Settings - Windows](#)

[Selecting Basic Print Settings - OS X](#)

[Selecting Page Setup Settings - OS X](#)

Related topics

[Loading Paper](#)

Incorrect Characters Print

If incorrect characters appear in your prints, try these solutions before reprinting:

- Make sure any cables are securely connected at both ends.
- In Windows, delete all jobs from the Windows Spooler. Click **Print Queue** on the Maintenance tab in the printer settings window, and cancel any stalled print jobs.
- If your product is connected to a USB hub, connect it directly to your computer instead.
- If your computer entered sleep mode the last time you printed, the next print job after your computer exits sleep mode may contain garbled characters. Print your document again.
- If incorrect characters still appear in your prints, try connecting your product using a different cable.

Parent topic: [Solving Page Layout and Content Problems](#)

Related tasks

[Selecting Basic Print Settings - Windows](#)

[Selecting Basic Print Settings - OS X](#)

[Selecting Page Setup Settings - OS X](#)

Incorrect Image Size or Position

If your printed image is the wrong size or in the wrong position, try these solutions:

- Make sure you selected the correct paper size and layout settings in your printing program and printer software.
- Make sure you selected the correct paper size on the control panel.
- Make sure your paper is positioned correctly for feeding into the printer.
- Clean the scanner glass and document cover.

You can use the preview option in your printer software to check your margins before you print.

Parent topic: [Solving Page Layout and Content Problems](#)

Related tasks

[Selecting Basic Print Settings - Windows](#)

[Selecting Basic Print Settings - OS X](#)

[Selecting Page Setup Settings - OS X](#)

Related topics

[Loading Paper](#)

Slanted Printout

If your printouts are slanted, try these solutions:

- Slide the edge guides against the edges of the paper.
- Select a higher print quality setting in your printer software.
- Turn off any high speed settings in your product software.
- Align the print head.
- Make sure the product is not printing while tilted or at an angle.

Parent topic: [Solving Page Layout and Content Problems](#)

Related tasks

[Selecting Basic Print Settings - Windows](#)

[Selecting Basic Print Settings - OS X](#)

Related topics

[Loading Paper](#)

Solving Print Quality Problems

Check these sections if your printouts have problems with print quality, but your image looks fine on your computer screen.

Note: When printing using AirPrint, the available print settings are different from those covered in this manual. See the Apple website for details.

[White or Dark Lines in Printout](#)

[Blurry or Smearred Printout](#)

[Faint Printout or Printout Has Gaps](#)

[Grainy Printout](#)

[Incorrect Colors](#)

Parent topic: [Solving Problems](#)

Related topics

[Solving Scanned Image Quality Problems](#)

White or Dark Lines in Printout

If you notice white or dark lines in your prints (also called banding), try these solutions before you reprint:

- Run a nozzle check to see if any of the print head nozzles are clogged. Then clean the print head, if necessary.
- Make sure the paper type setting matches the type of paper you loaded.
- Make sure you loaded the printable side of the paper correctly for your product.
- Turn off any high speed settings in your product software.
- Align the print head.
- You may need to refill the ink. Visually check the ink levels.
- If you have not used the product for a long time, run the Power Ink Flushing utility.

Note: Flushing the ink tubes replaces all the ink inside the tubes, so flush the ink only if you cannot improve print quality by other means. See the ink flushing section for details.

Parent topic: [Solving Print Quality Problems](#)

Related concepts

[Print Head Nozzle Check](#)

[Print Head Cleaning](#)

[Print Head Alignment](#)

[Power Ink Flushing](#)

Related references

[Paper or Media Type Settings - Product Software](#)

Related tasks

[Selecting Additional Layout and Print Options - Windows](#)

[Selecting Printing Preferences - OS X](#)

Related topics

[Loading Paper](#)

[Refilling Ink](#)

Blurry or Smearred Printout

If your printouts are blurry or smearred, try these solutions:

- Make sure your paper is not damp, curled, old, or loaded incorrectly in your product.
- Use a support sheet with special paper, or load special paper one sheet at a time.
- Make sure your paper meets the specifications for your product.
- Use Epson papers to ensure proper saturation and absorption of genuine Epson inks.
- Make sure the paper type setting in your product software matches the type of paper you loaded.
- Make sure you loaded the printable side of the paper correctly for your product.
- Remove each sheet from the output tray as it is printed.
- Avoid handling printouts on glossy paper right after printing to allow the ink to set.
- Turn off any high speed settings in your product software.
- If you print on both sides of a sheet of paper, smudges may appear on the reverse side of heavily saturated or dark images. If one side of a sheet will contain a lighter image or text, print that side first. Adjust the **Print Density** and/or **Increase Ink Drying Time** settings.
- If printed copies are smearred, lower the copy density setting on the product control panel.

- Run a nozzle check to see if any of the print head nozzles are clogged. Then clean the print head, if necessary.
- Align the print head.
- Clean the paper path.
- If you have not used the product for a long time, run the Power Ink Flushing utility.

Note: Flushing the ink tubes replaces all the ink inside the tubes, so flush the ink only if you cannot improve print quality by other means. See the ink flushing section for details.

Note: Your product will not operate properly while tilted at an angle. Place it on a flat, stable surface that extends beyond the base of the product in all directions.

Parent topic: [Solving Print Quality Problems](#)

Related concepts

[Print Head Nozzle Check](#)

[Print Head Cleaning](#)

[Print Head Alignment](#)

[Print Head Cleaning](#)

[Print Head Alignment](#)

Related references

[Available Epson Papers](#)

[Paper Specifications](#)

Related tasks

[Selecting Basic Print Settings - Windows](#)

[Selecting Additional Layout and Print Options - Windows](#)

[Selecting Extended Settings - Windows](#)

[Selecting Basic Print Settings - OS X](#)

[Selecting Printing Preferences - OS X](#)

[Cleaning the Paper Path](#)

Faint Printout or Printout Has Gaps

If your printouts are faint or have gaps, try these solutions:

- Run a nozzle check to see if any of the print head nozzles are clogged. Then clean the print head, if necessary.
- The ink levels may be low. Visually check the ink levels.
- Make sure the paper type setting matches the type of paper you loaded.
- Make sure your paper is not damp, curled, old, or loaded incorrectly in your product.
- Align the print head.
- Clean the paper path.

Parent topic: [Solving Print Quality Problems](#)

Related concepts

[Print Head Nozzle Check](#)

[Print Head Cleaning](#)

[Print Head Alignment](#)

Related references

[Paper or Media Type Settings - Product Software](#)

[Paper Type Settings - Control Panel](#)

Related tasks

[Cleaning the Paper Path](#)

Related topics

[Loading Paper](#)

[Refilling Ink](#)

Grainy Printout

If your printouts are grainy, try these solutions:

- Make sure you loaded the printable side of the paper correctly for your product.
- Select a higher print quality setting and turn off any high speed settings in your product software.
- Run a nozzle check to see if any of the print head nozzles are clogged. Then clean the print head, if necessary.
- Align the print head.

- You may need to increase the image resolution or print a smaller size; see your software documentation.

Note: Images from the Internet may be low resolution and not result in a high quality printout.

- If you enlarged the image in an image-editing program, you need to increase the resolution setting to retain a high image quality. Increase the resolution by the same amount you increased the image size. For example, if the resolution is 300 dpi (dots per inch) and you will double the image size later, change the resolution setting to 600 dpi.

Note: Higher resolution settings result in larger file sizes, which take longer to process and print. Consider the limitations of your computer system when selecting a resolution, and select the lowest possible resolution that produces acceptable quality to keep file sizes manageable.

Parent topic: [Solving Print Quality Problems](#)

Related concepts

[Print Head Nozzle Check](#)

[Print Head Cleaning](#)

[Print Head Alignment](#)

Related tasks

[Selecting Basic Print Settings - Windows](#)

[Selecting Additional Layout and Print Options - Windows](#)

[Selecting Basic Print Settings - OS X](#)

[Selecting Printing Preferences - OS X](#)

Incorrect Colors

If your printouts have incorrect colors, try these solutions:

- Make sure the paper type setting matches the paper you loaded.
- Make sure the **Black/Grayscale** or **Grayscale** setting is not selected in your printer software.
- If you selected **Standard-Vivid** (Windows) or **Normal-Vivid** (OS X) as the quality setting in the printer software, try selecting **Standard** (Windows) or **Normal** (OS X) instead.
- Run a nozzle check to see if any of the print head nozzles are clogged. Then clean the print head, if necessary.
- The ink levels may be low and you may need to refill the ink. Visually check the ink levels. Also make sure you filled the tanks with the correct colors of ink.

- After you print, the colors in your printout need time to set as the ink dries. During this time, the colors may look different than you expect. To speed up drying time, do not stack your printouts on top of each other.
- Your printed colors can never exactly match your on-screen colors. However, you can use a color management system to get as close as possible. Try using the color management options in your printer software.
- For best results, use genuine Epson ink and paper.
- If you have not used the product for a long time, run the Power Ink Flushing utility.

Note: Flushing the ink tubes replaces all the ink inside the tubes, so flush the ink only if you cannot improve print quality by other means. See the ink flushing section for details.

Parent topic: [Solving Print Quality Problems](#)

Related concepts

[Print Head Nozzle Check](#)

[Print Head Cleaning](#)

[Power Ink Flushing](#)

Related references

[Available Epson Papers](#)

Related tasks

[Selecting Basic Print Settings - Windows](#)

[Selecting Additional Layout and Print Options - Windows](#)

[Selecting Basic Print Settings - OS X](#)

[Managing Color - OS X](#)

Related topics

[Refilling Ink](#)

Solving Scanning Problems

Check these solutions if you have problems scanning with your product.

[Scanning Software Does Not Operate Correctly](#)

[Cannot Start Epson Scan](#)

Parent topic: [Solving Problems](#)

Scanning Software Does Not Operate Correctly

If your scanning software does not operate correctly, try these solutions:

- Make sure your computer has adequate memory and meets the system requirements for your operating system.
- Make sure your computer is not running in a power-saving mode, such as sleep or standby. If so, wake your system and restart your scanning software.
- If you upgraded your operating system but did not reinstall your scanning software, try reinstalling it.

Note: With OS X, in addition to scanning with Image Capture, you can download and install Epson Scan scanning software. Epson Scan provides additional image adjustment and photo correction features for enhancing scanned images, and provides an interface for TWAIN-compliant OCR scanning software. To download Epson Scan, visit Epson's driver download site ([U.S. downloads](#) or [Canadian downloads](#)).

Parent topic: [Solving Scanning Problems](#)

Related concepts

[Uninstall Your Product Software](#)

Related references

[Windows System Requirements](#)

[OS X System Requirements](#)

Related tasks

[Scanning with OS X Using Image Capture](#)

Cannot Start Epson Scan

If you cannot start Epson Scan, try these solutions:

- Make sure your product is turned on and any interface cables are securely connected at both ends.
- Make sure Epson Scan is selected in your scanning program.
- Make sure your computer is not running in a power-saving mode, such as sleep or standby. If so, wake your system and restart Epson Scan.
- Check the connection setting and test the connection using Epson Scan Settings:

Windows 8.x: Navigate to the **Apps** screen and select **EPSON Scan Settings**. Make sure the correct **Connection** setting is selected, then click the **Test** button.

Windows (other versions): Click  or **Start > All Programs** or **Programs > EPSON > EPSON Scan > EPSON Scan Settings**. Make sure the correct **Connection** setting is selected, then click the **Test** button.

OS X: Open the **Applications** folder, click **Epson Software**, and click **EPSON Scan Settings**. Make sure the correct **Connection** setting is selected, then click the **Test** button.

- Make sure you do not have multiple versions of Epson Scan installed. If you do, uninstall both versions and install one version.
- If you upgraded your operating system but did not reinstall Epson Scan, try reinstalling it.

Note: With OS X, in addition to scanning with Image Capture, you can download and install Epson Scan scanning software. Epson Scan provides additional image adjustment and photo correction features for enhancing scanned images, and provides an interface for TWAIN-compliant OCR scanning software. To download Epson Scan, visit Epson's driver download site ([U.S. downloads](#) or [Canadian downloads](#)).

Parent topic: [Solving Scanning Problems](#)

Related tasks

[Scanning with OS X Using Image Capture](#)

Related topics

[Starting a Scan](#)

Solving Scanned Image Quality Problems

Check these sections if a scanned image on your computer screen has a quality problem.

[Image Consists of a Few Dots Only](#)

[Line of Dots Appears in All Scanned Images](#)

[Straight Lines in an Image Appear Crooked](#)

[Image is Distorted or Blurry](#)

[Image Colors are Patchy at the Edges](#)

[Image is Too Dark](#)

[Back of Original Image Appears in Scanned Image](#)

[Ripple Patterns Appear in an Image](#)

[Image is Scanned Upside-Down](#)

[Scanned Image Colors Do Not Match Original Colors](#)

[Scan Area is Not Adjustable in Thumbnail Preview](#)

[Scanned Image Edges are Cropped](#)

Parent topic: [Solving Problems](#)

Image Consists of a Few Dots Only

If your scanned image consists only of a few dots, try these solutions:

- Make sure you placed your original for scanning facing the correct way.
- If you are scanning using the Epson Scan **Black & White** setting, adjust the **Threshold** setting and scan again.

Parent topic: [Solving Scanned Image Quality Problems](#)

Related references

[Available Image Adjustments - Office Mode](#)

[Available Image Adjustments - Home Mode](#)

[Available Image Adjustments - Professional Mode](#)

Related tasks

[Placing Originals on the Scanner Glass](#)

Line of Dots Appears in All Scanned Images

If a line of dots appears in all your scanned images, clean the scanner glass with a soft, dry, lint-free cloth or use a small amount of glass cleaner on the cloth, if necessary. Paper towels are not recommended.

Caution: Do not spray glass cleaner directly on the scanner glass.

Parent topic: [Solving Scanned Image Quality Problems](#)

Related tasks

[Cleaning Your Product](#)

Straight Lines in an Image Appear Crooked

If straight lines in an original appear crooked in a scanned image, make sure to place your original straight when you scan it.

Parent topic: [Solving Scanned Image Quality Problems](#)

Related tasks

[Placing Originals on the Scanner Glass](#)

Image is Distorted or Blurry

If a scanned image appears distorted or blurry, try these solutions:

- Make sure your original is not wrinkled or warped. This may prevent the original from laying flat on the scanner glass.
- Do not move your original or your product during scanning.
- Your product will not operate properly while tilted at an angle. Place your product on a flat, stable surface that extends beyond its base in all directions.
- Adjust these Epson Scan settings (if available) and try scanning again:
 - Select the **Unsharp Mask** setting.
 - Adjust the **Auto Exposure** setting.
 - Increase the **Resolution** setting.

Parent topic: [Solving Scanned Image Quality Problems](#)

Related topics

[Selecting Epson Scan Settings](#)

Image Colors are Patchy at the Edges

If you are scanning a thick or warped original, cover its edges with paper to block external light as you scan it.

Parent topic: [Solving Scanned Image Quality Problems](#)

Image is Too Dark

If your scanned image is too dark, try these solutions:

- Adjust these Epson Scan settings (if available) and try scanning again:
 - **Auto Exposure**
 - **Brightness**
 - **Histogram Adjustment**
- Check the brightness and contrast settings of your computer monitor.

Parent topic: [Solving Scanned Image Quality Problems](#)

Related topics

[Selecting Epson Scan Settings](#)

Back of Original Image Appears in Scanned Image

If an image from the back of a thin original appears in your scanned image, place a piece of black paper on the back of the original and scan it again.

Parent topic: [Solving Scanned Image Quality Problems](#)

Ripple Patterns Appear in an Image

You may see a ripple pattern (called a moiré) in scanned images of printed documents. This is caused by interference from differing pitches in the scanner's screen and your original's halftone screen. To reduce this effect, adjust these Epson Scan settings (if available) and try scanning again:

- Select the **Descreening** setting.
- Select a lower **Resolution** setting.

Parent topic: [Solving Scanned Image Quality Problems](#)

Related topics

[Selecting Epson Scan Settings](#)

Image is Scanned Upside-Down

Your product scans using the **Auto Photo Orientation** setting. This setting checks the preview image for faces, the sky, and other features, and then correctly rotates the photo when it is scanned, if necessary. If your photo is not oriented correctly using this option, deselect the **Auto Photo Orientation** setting and scan again.

Note: **Auto Photo Orientation** will not work when you scan newspapers, magazines, documents, illustrations, or line art, or images smaller than 2 inches (5.1 cm) on any side.

Parent topic: [Solving Scanned Image Quality Problems](#)

Scanned Image Colors Do Not Match Original Colors

Printed colors can never exactly match the colors on your computer monitor because printers and monitors use different color systems: monitors use RGB (red, green, and blue) and printers typically use CMYK (cyan, magenta, yellow, and black).

Check the color matching and color management capabilities of your computer, display adapter, and the software you are using to see if they are affecting the palette of colors you see on your screen.

To adjust the colors in your scanned image, adjust these Epson Scan settings (if available) and try scanning again:

- Change the **Image Type** setting and experiment with different combinations of the next settings.
- Adjust the **Tone Correction** setting.
- Adjust the **Auto Exposure** setting.

Parent topic: [Solving Scanned Image Quality Problems](#)

Related topics

[Selecting Epson Scan Settings](#)

Scan Area is Not Adjustable in Thumbnail Preview

If you cannot adjust the scan area while viewing a Thumbnail preview in Epson Scan, try these solutions:

- Create a scan area by drawing a marquee on your preview image and adjusting it as necessary.
- Switch to Normal preview mode, if available, and preview your image again.

Parent topic: [Solving Scanned Image Quality Problems](#)

Related concepts

[Image Preview Guidelines](#)

Related tasks

[Selecting a Scan Area - Office Mode](#)

[Selecting a Scan Area - Home Mode](#)

[Selecting a Scan Area - Professional Mode](#)

Scanned Image Edges are Cropped

If the edges of a scanned image are cropped, make sure your original is placed correctly for scanning. If necessary, move your original away from the edges of the scanner glass slightly.

Parent topic: [Solving Scanned Image Quality Problems](#)

Related tasks

[Placing Originals on the Scanner Glass](#)

Solving Faxing Problems

Check these solutions if you have problems faxing with your product.

[Cannot Send or Receive Faxes](#)

Cannot Receive Faxes with a Telephone Connected to Your Product

Parent topic: [Solving Problems](#)

Cannot Send or Receive Faxes

If you cannot send or receive faxes, try these solutions:

- If you are faxing from a computer, use the Epson FAX Utility to send your fax.
- Make sure the recipient's fax machine is turned on and working.
- Make sure paper is loaded correctly in your product.
- Make sure you have set up your header information and have not blocked your caller ID. Otherwise, your faxes might be rejected by the recipient's fax machine.
- If you did not connect a telephone to your product, set the Receive Mode setting to **Auto** so you can receive faxes automatically.
- Check that the cable connecting your telephone wall jack to your product's **LINE** port is secure.
- Print a fax connection report using your product control panel or fax software to help diagnose the problem.
- Verify that the telephone wall jack works by connecting a phone to it and testing it.
- If there is no dial tone and you connected the product to a PBX (Private Branch Exchange) phone line or Terminal Adapter, change the **Line Type** setting to **PBX**. If you still cannot send a fax, turn off the turn off the product's dial tone detection setting. (Turning off the dial tone setting may cause the product to drop the first digit of a fax number.)
- If you connected your product to a DSL phone line, you must connect a DSL filter to the phone jack to enable faxing over the line. Contact your DSL provider for the necessary filter.
- If your telephone line has static, turn off your product's error correction mode fax communication setting and try faxing again.
- Try lowering your product's fax speed setting.
- Make sure the error correction mode (ECM) setting is turned on if you are trying to send or receive a color fax.
- If your telephone line uses call waiting and you have trouble receiving faxes, turn off call waiting to prevent disruption of incoming faxes.
- If you have subscribed to a call forwarding service, the product may not be able to receive faxes. Contact your service provider for assistance.

Note: If your product is connected to a VoIP (Voice over Internet Protocol) phone line, keep in mind that fax machines are designed to work over analog phone lines. Epson cannot guarantee that fax transmission will work when using VoIP.

If your phone line includes voice mail answering services, calls or faxes may be inadvertently received by your voice mail service.

Parent topic: [Solving Faxing Problems](#)

Related references

[Basic Settings - Fax](#)

[Receive Settings - Fax](#)

Related tasks

[Receiving Faxes Automatically](#)

[Printing Fax Reports](#)

[Connecting a Telephone or Answering Machine](#)

[Selecting Advanced Fax Settings](#)

Related topics

[Placing Originals on the Product](#)

[Loading Paper](#)

Cannot Receive Faxes with a Telephone Connected to Your Product

If you cannot receive faxes when a telephone is connected to your product, try these solutions:

- Make sure your telephone is connected to your product's **EXT** port.
- Make sure the Receive Mode is set to **Manual**.

Note: When answering a call that is a fax, wait until the product's LCD screen displays a message that a connection has been made before you hang up.

Parent topic: [Solving Faxing Problems](#)

Related tasks

[Connecting a Telephone or Answering Machine](#)

Message Appears Prompting You to Reset Ink Levels

If you see a message on the LCD screen prompting you to reset the ink levels, do the following:

1. Refill all of the ink tanks or the ink tanks indicated on the LCD screen all the way to the top.

Note: Depending on the operating conditions, you may see the ink reset message even when there is still ink in the tanks.

2. Select the colors that you refilled on the LCD screen.
3. Follow the instructions on the LCD screen to reset the ink levels.

Note: The product has a low ink alert system. The accuracy of this system depends on the user refilling the ink tanks correctly. The product cannot directly measure the ink levels in the tanks; instead it estimates the amount of ink remaining by internally monitoring ink usage. The low ink alert system may generate inaccurate messages if the ink tanks are not refilled according to these instructions.

Visually check the ink levels in the product's ink tanks to confirm the actual ink levels. Continued use of the product when the ink is expended could damage the product.

Parent topic: [Solving Problems](#)

Related tasks

[Refilling the Ink Tanks](#)

Uninstall Your Product Software

If you have a problem that requires you to uninstall and re-install your software, follow the instructions for your operating system.

[Uninstalling Product Software - Windows](#)

[Uninstalling Product Software - OS X](#)

Parent topic: [Solving Problems](#)

Uninstalling Product Software - Windows

You can uninstall and then re-install your product software to solve certain problems.

1. Turn off the product.
2. Disconnect any interface cables.

3. Do one of the following:

- **Windows 8.x:** Navigate to the **Apps** screen and select **Control Panel > Programs > Programs and Features**. Select the uninstall option for your Epson product, then select **Uninstall/Change**.

Note: If you see a **User Account Control** window, click **Yes** or **Continue**.

Select your product again, if necessary, then select **OK**, and click **Yes** to confirm the uninstallation.

- **Windows (other versions):** Click  or **Start**, and select **All Programs** or **Programs**. Select **EPSON**, select your product, then click **EPSON Printer Software Uninstall**.

Note: If you see a **User Account Control** window, click **Yes** or **Continue**.

In the next window, select your product and click **OK**. Then follow any on-screen instructions.

4. Do one of the following to uninstall Epson Event Manager, then follow any on-screen instructions:

- **Windows 8.x:** Select **Epson Event Manager** and click **Uninstall**.
- **Windows 7/Windows Vista:** Open the Windows **Control Panel** utility. Select **Programs and Features**. (In Classic view, select **Programs** and click **Uninstall a program**.) Select **Epson Event Manager** and click **Uninstall/Change**.
- **Windows XP:** Open the Windows **Control Panel** utility. Double-click **Add or Remove Programs**. Select **Epson Event Manager** and click **Change/Remove**.

5. Do one of the following to uninstall Epson Scan, then follow any on-screen instructions:

- **Windows 8.x/Windows 7/Windows Vista:** Select **EPSON Scan** and click **Uninstall/Change**.
- **Windows XP:** Select **EPSON Scan** and click **Change/Remove**.

6. Restart your computer, then see the *Start Here* sheet to re-install your software.

Note: If you find that re-installing your product software does not solve a problem, contact Epson.

Parent topic: [Uninstall Your Product Software](#)

Uninstalling Product Software - OS X

In most cases, you do not need to uninstall your product software before re-installing it. However, you can download the Uninstaller utility from the Epson support website to uninstall your product software as described here.

Note: If you find that re-installing your product software does not solve a problem, contact Epson.

1. To download the Uninstaller utility, visit the Epson download site ([U.S. downloads](#) or [Canadian downloads](#)).
2. Follow the instructions on the screen to install the Uninstaller utility.
3. Quit all applications currently running on your Mac.
4. Double-click the **Uninstaller** icon.
5. Select the checkbox for each software program you want to uninstall.
6. Click **Uninstall**.
7. Follow the on-screen instructions to uninstall the software.
8. To reinstall your product software, see the *Start Here* sheet for instructions.

Note: If you uninstall the printer driver and your product name remains in the **Print & Fax, Print & Scan,** or **Printers & Scanners** window, select your product name and click the – (remove) icon to remove it.

Parent topic: [Uninstall Your Product Software](#)

Where to Get Help

If you need to contact Epson for technical support services, use the following support options.

Internet Support

Visit Epson's support website at epson.com/support (U.S.) or epson.ca/support (Canada) for solutions to common problems. You can download drivers and documentation, get FAQs and troubleshooting advice, or e-mail Epson with your questions.

Speak to a Support Representative

Before you call Epson for support, please have the following information ready:

- Product name
- Product serial number (located on a label on the product)
- Proof of purchase (such as a store receipt) and date of purchase
- Computer configuration
- Description of the problem

Then call:

- U.S.: (562) 276-4382, 6 AM to 8 PM, Pacific Time, Monday through Friday, and 7 AM to 4 PM, Pacific Time, Saturday
- Canada: (905) 709-3839, 6 AM to 8 PM, Pacific Time, Monday through Friday, and 7 AM to 4 PM, Pacific Time, Saturday

Days and hours of support are subject to change without notice. Toll or long distance charges may apply.

Purchase Supplies and Accessories

You can purchase genuine Epson ink and paper at [epson.com/ink3](https://www.epson.com/ink3) (U.S. sales) or [epson.ca](https://www.epson.ca) (Canadian sales). You can also purchase supplies from an Epson authorized reseller. To find the nearest one, call 800-GO-EPSON (800-463-7766).

Parent topic: [Solving Problems](#)

Technical Specifications

These sections list the technical specifications for your product.

Note: Epson offers a recycling program for end of life products. Please go to [this site](#) for information on how to return your products for proper disposal.

[Windows System Requirements](#)

[OS X System Requirements](#)

[Scanning Specifications](#)

[Paper Specifications](#)

[Printable Area Specifications](#)

[Ink Specifications](#)

[Fax Specifications](#)

[Dimension Specifications](#)

[Electrical Specifications](#)

[Environmental Specifications](#)

[Interface Specifications](#)

[Network Interface Specifications](#)

[Safety and Approvals Specifications](#)

Windows System Requirements

To use your product and its software, your computer should use one of these Microsoft operating systems:

- Windows 10
- Windows 8.x
- Windows 7
- Windows Vista
- Windows XP Professional x64 Edition
- Windows XP SP3

Note: Visit Epson's support website at epson.com/support (U.S.) or epson.ca/support (Canada) for the latest in compatibility and drivers for your product.

Parent topic: [Technical Specifications](#)

OS X System Requirements

To use your product and its software, your Mac should use one of these operating systems:

- OS X 10.10.x
- OS X 10.9.x
- OS X 10.8.x
- OS X 10.7.x
- OS X 10.6.8

Note: Visit Epson's support website at epson.com/support (U.S.) or epson.ca/support (Canada) for the latest in compatibility and drivers for your product.

Parent topic: [Technical Specifications](#)

Scanning Specifications

Scanner type	Flatbed
Photoelectric device	CIS
Effective pixels	10200 × 14040 pixels (1200 dpi)
Maximum document size	8.5 × 11.7 inches (216 × 297 mm) US letter or A4
Scanning resolution	1200 dpi (main scan) 2400 dpi (sub scan)
Output resolution	50 to 4800, 7200, 9600 dpi (50 to 4800 dpi in 1 dpi increments)

Color depth

Color:

48 bits per pixel internal (16 bits per pixel per color internal)

24 bits per pixel external (8 bits per pixel per color external)

Grayscale:

16 bits per pixel internal

8 bits per pixel external

Black-and-white:

16 bits per pixel internal

1 bit per pixel external

Light source

LED

Parent topic: [Technical Specifications](#)

Paper Specifications

Note: Since the quality of any particular brand or type of paper may be changed by the manufacturer at any time, Epson cannot guarantee the quality of any non-Epson brand or type of paper. Always test a sample of paper stock before purchasing large quantities or printing large jobs.

Single-sheets**Paper types**

Plain paper and paper distributed by Epson

WeightPlain paper: 17 lb (64 g/m²) to 24 lb (90 g/m²)**Envelopes****Size**

No. 10 (4.1 × 9.5 inches [105 × 241 mm])

Weight20 lb (75 g/m²) to 24 lb (90 g/m²)**Parent topic:** [Technical Specifications](#)**Related references**[Paper Loading Capacity](#)

Printable Area Specifications

Note: Print quality may decline in the shaded areas shown here due to the printer mechanism.

Single sheets - normal printing

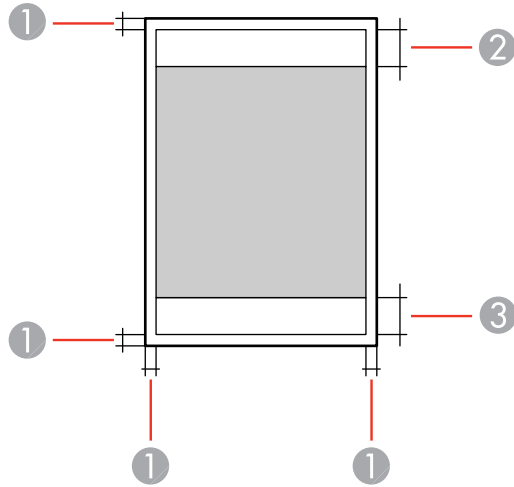

- 1 Margin: 0.12 inch (3 mm) minimum
- 2 Reduced print quality area/top: 1.85 inch (47 mm) minimum
- 3 Reduced print quality area/bottom: 1.77 inch (45 mm) minimum

Envelopes

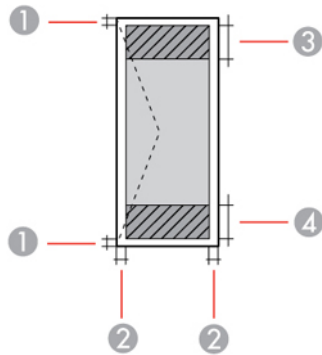

- 1 Left/right margins: 0.12 inch (3 mm) minimum
- 2 Top/bottom margins: 0.20 inch (5 mm) minimum
- 3 Reduced print quality area/right: 1.85 inches (47 mm) minimum
- 4 Reduced print quality area/left: 0.71 inch (18 mm) minimum

Parent topic: [Technical Specifications](#)

Ink Specifications

Note: This product was originally designed to work with genuine Epson inks. Your product may not function properly if you use other types of ink and may affect Epson's warranty.

The included ink bottles must be used for printer setup and are not for resale. The printer ships with full ink bottles and part of the ink from the first bottles is used to charge the print head. Yields vary considerably based on images printed, print settings, paper type, frequency of use, and temperature.

The ink bottles that came with your printer have a lower yield due to the ink charging process. This process is carried out the first time you turn on the printer and guarantees better performance. Do not load paper before refilling the ink tanks.

Color Black, Cyan, Magenta, Yellow

Ink life For best results, use up ink within 6 months of removing the seal from an ink bottle

Temperature Storage: -4 to 104 °F (-20 to 40 °C)
1 month at 104 °F (40 °C)
Ink freezes at 5 °F (-15 °C)
Ink thaws and is usable after 2 hours at 77 °F (25 °C)

Parent topic: [Technical Specifications](#)

Related references

[Ink Bottle Part Numbers](#)

Fax Specifications

Fax type	Walk-up black-and-white and color fax capability (ITU-T Super Group 3)
Support line	Standard analog telephone lines and PBX (Private Branch Exchange) telephone systems
Speed	Up to 33.6 kbps
Resolution	Monochrome Standard: 203 × 98 dpi Fine: 203 × 196 dpi Photo: 203 × 196 dpi Color Fine: 200 × 200 dpi Photo: 200 × 200 dpi
Page memory	Up to 100 pages (ITU-T No. 1 chart in monochrome draft mode)
Redial	2 times (with 1 minute intervals); specifications depend on country and region
Interface	RJ-11 Phone Line RJ-11 Telephone set connection

Parent topic: [Technical Specifications](#)

Dimension Specifications

Height	Stored: 9.5 inches (241 mm) Printing: 9.5 inches (241 mm)
Width	Stored: 20.3 inches (515 mm) Printing: 20.3 inches (515 mm)
Depth	Stored: 14.2 inches (360 mm) Printing: 22.0 inches (559 mm)
Weight (without ink and power cord)	16.3 lb (7.4 kg)

Parent topic: [Technical Specifications](#)

Electrical Specifications

Power supply rating	100 to 240 V
Rated frequency range	50/60 Hz
Rated current	0.5 to 0.3 A
Power consumption (USB connection)	Standalone copying: Approximately 11 W (ISO/IEC24712) Ready mode: Approximately 4.4 W Sleep mode: Approximately 1.5 W Power off mode: Approximately 0.3 W

Parent topic: [Technical Specifications](#)

Environmental Specifications

Temperature	Operating: 50 to 95 °F (10 to 35 °C) Storage: -4 to 104 °F (-20 to 40 °C) 1 month at 104 °F (40 °C)
--------------------	---

Humidity	Operating: 20 to 80% RH
(without condensation)	Storage: 5 to 85% RH

Parent topic: [Technical Specifications](#)

Interface Specifications

One Hi-Speed USB port for a computer

Parent topic: [Technical Specifications](#)

Network Interface Specifications

Wi-Fi

Standards	IEEE 802.11 b/g/n
Security	WEP (64/128 bit) WPA-PSK (AES); complies with WPA2 with support for WPA/WPA2 Personal
Frequency range	2.4 GHz
Coordination modes	Infrastructure mode Ad hoc mode (not supported for IEEE 802.11n) Wi-Fi Direct (not supported for IEEE 802.11b)
	Note: Simple AP mode is compatible with Wi-Fi infrastructure mode and Ethernet connections.

Ethernet

Standard	IEEE802.3i/u (10BASE-T) IEEE802.3u (100BASE-TX) IEEE802.3az (Energy Efficient Ethernet; connected device should be IEEE802.3az compliant)
Communication mode	Auto, 10Mbps Full duplex, 10Mbps Half duplex, 100 Mbps Full duplex, 100Mbps Half duplex

Connector RJ-45

Security Protocol

SSL/TLS: HTTPS Server/Client, IPPS

Parent topic: [Technical Specifications](#)

Safety and Approvals Specifications

United States	Safety: UL60950-1 EMC: FCC part 15 Subpart B class B
Canada	Safety: CAN/CSA C22.2 No. 60950-1 EMC: CAN/CSA-CEI/IEC CISPR 22 Class B

This equipment contains the following wireless module:

- Manufacturer: Askey Computer Corporation.
- Type: WLU6320-D69 (RoHS)

This product conforms to Part 15 of FCC Rules and RSS-210 of the IC Rules. Epson cannot accept responsibility for any failure to satisfy the protection requirements resulting from a non-recommended modification of the product. Operation is subject to the following two conditions: (1) this device may not cause harmful interference, and (2) this device must accept any interference received, including interference that may cause undesired operation of the device.

To prevent radio interference to the licensed service, this device is intended to be operated indoors and away from windows to provide maximum shielding. Equipment (or its transmit antenna) that is installed outdoors is subject to licensing.

This equipment complies with FCC/IC radiation exposure limits set forth for an uncontrolled environment and meets the FCC radio frequency (RF) Exposure Guidelines in Supplement C to OET65 and RSS-102 of the IC radio frequency (RF) Exposure rules. This equipment should be installed and operated so that the radiator is kept at least 7.9 inches (20 cm) or more away from a person's body (excluding extremities: hands, wrists, feet and ankles).

Parent topic: [Technical Specifications](#)

Notices

Check these sections for important notices about your product.

Note: Epson offers a recycling program for end of life products. Please go to [this site](#) for information on how to return your products for proper disposal.

[Important Safety Instructions](#)

[FCC Compliance Statement](#)

[Trademarks](#)

[Copyright Notice](#)

Important Safety Instructions

Before using your Epson product, read and follow these safety instructions.

[General Product Safety Instructions](#)

[Wireless Connection Safety Instructions](#)

[Telephone Equipment Safety Instructions](#)

[LCD Screen Safety Instructions](#)

Parent topic: [Notices](#)

Related references

[Ink Safety Precautions](#)

General Product Safety Instructions

- Be sure to follow all warnings and instructions marked on the product.
- Use only the type of power source indicated on the product's label.
- Use only the power cord that comes with the product. Use of another cord may cause fires or shock. Do not use the cord with any other equipment.
- Place the product near a wall outlet where the plug can be easily unplugged.
- Avoid plugging the product into an outlet on the same circuit as a photo copier or air control system that regularly switches on and off, or on an outlet controlled by a wall switch or timer.
- Do not let the power cord become damaged or frayed. Place it to avoid abrasions, cuts, fraying, crimping, and kinking. Do not place objects on top of it and do not allow it to be stepped on or run over. Be careful to keep the cord straight at each end.

- If you use an extension cord with the product, make sure the total ampere rating of the devices plugged into the extension cord does not exceed the cord's ampere rating. Also, make sure the total ampere rating of all devices plugged into the wall outlet does not exceed the wall outlet's ampere rating.
- Always turn off the product using the power button, and wait until the power light stops flashing before unplugging the product or cutting off power to the electrical outlet.
- If you will not be using the product for a long period, unplug the power cord from the electrical outlet.
- Place the product on a flat, stable surface that extends beyond its base in all directions. It will not operate properly if it is tilted or at an angle.
- Allow space behind the product for the cables, and space above the product so that you can fully raise the document cover.
- Leave enough space in front of the product for the paper to be fully ejected.
- Avoid locations that are subject to rapid changes in heat or humidity, shocks or vibrations, or dust.
- Do not place or store the product outdoors.
- Do not place the product near excessive heat sources or in direct sunlight.
- Leave enough room around the product for sufficient ventilation. Do not block or cover openings in the case or insert objects through the slots.
- Keep the product away from potential sources of electromagnetic interference, such as loudspeakers or the base units of cordless telephones.
- When connecting the product to a computer or other device with a cable, ensure the correct orientation of the connectors. Each connector has only one correct orientation. Inserting a connector in the wrong orientation may damage both devices connected by the cable.
- Do not touch the flat white cable inside the product.
- Do not move the print head by hand; this may damage the product.
- Do not spill liquid on the product or use the product with wet hands.
- Do not use aerosol products that contain flammable gases inside or around the product. Doing so may cause fire.
- Do not press too hard on the document table when placing originals.
- Do not open the scanner section while the product is copying, printing, scanning, or performing any other functions.
- Be careful not to trap your fingers when closing the document cover or scanner.
- Except as specifically explained in your documentation, do not attempt to service the product yourself.

- Unplug the product and refer servicing to qualified service personnel under the following conditions: if the power cord or plug is damaged; if liquid has entered the product; if the product has been dropped or the case damaged; if the product does not operate normally or exhibits a distinct change in performance. Adjust only those controls that are covered by the operating instructions.
- Before transporting the product, make sure that the print head is in the home (far right) position.
- When storing or transporting the product, do not tilt it, stand it on its side, or turn it upside down; otherwise ink may leak.

Parent topic: [Important Safety Instructions](#)

Wireless Connection Safety Instructions

Radio waves from this product may adversely affect the operation of medical equipment or automatically controlled devices, such as pacemakers, automatic doors or fire alarms. When using this product near such devices or inside a medical facility, follow the directions from authorized staff members at the facility, and follow all posted warnings and directions on the device to avoid causing an accident.

Parent topic: [Important Safety Instructions](#)

Telephone Equipment Safety Instructions

When using telephone equipment, you should always follow basic safety precautions to reduce the risk of fire, electric shock, and personal injury, including the following:

- Do not use the Epson product near water.
- Avoid using a telephone during an electrical storm. There may be a remote risk of electric shock from lightning.
- Do not use a telephone to report a gas leak in the vicinity of the leak.

Caution: To reduce the risk of fire, use only a No. 26 AWG or larger telecommunication line cord.

Parent topic: [Important Safety Instructions](#)

LCD Screen Safety Instructions

- Use only a dry, soft cloth to clean the LCD screen. Do not use liquid or chemical cleansers.
- If the LCD screen is damaged, contact Epson. If the liquid crystal solution gets on your hands, wash them thoroughly with soap and water. If the liquid crystal solution gets into your eyes, flush them immediately with water. If discomfort or vision problems remain after a thorough flushing, see a doctor immediately.

- Do not press too hard on the LCD screen.
- Do not use a pointy or sharp object, such as a pen or your fingernail, to operate the LCD screen.

Parent topic: [Important Safety Instructions](#)

FCC Compliance Statement

For United States Users

This equipment complies with Part 68 of the FCC rules and the requirements adopted by the Administrative Council for Terminal Attachments ("ACTA") . On the surface of this equipment is a label that contains, among other information, a product identifier in the format US:AAAEQ##TXXXX. If requested, this number must be provided to the telephone company.

Applicable certification jack Universal Service Order Codes ("USOC") for the equipment: RJ11C.

A plug and jack used to connect this equipment to the premises wiring and telephone network must comply with the applicable FCC Part 68 rules and requirements adopted by the ACTA. A compliant telephone cord and modular plug is provided with this product. It is designed to be connected to a compatible modular jack that is also compliant. See installation instructions for details.

The REN is used to determine the number of devices that may be connected to a telephone line. Excessive RENs on a telephone line may result in the devices not ringing in response to an incoming call. In most but not all areas, the sum of RENs should not exceed five (5.0). To be certain of the number of devices that may be connected to a line, as determined by the total RENs, contact the local telephone company. For products approved after July 23, 2001 , the REN for this product is part of the product identifier that has the format US:AAAEQ##TXXXX. The digits represented by ## are the REN without a decimal point (e.g., 03 is a REN of 0.3). For earlier products, the REN is separately shown on the label.

If this equipment causes harm to the telephone network, the telephone company will notify you in advance that temporary discontinuance of service may be required. But if advance notice isn't practical, the telephone company will notify the customer as soon as possible. Also, you will be advised of your right to file a complaint with the FCC if you believe it is necessary.

The telephone company may make changes in its facilities, equipment, operations or procedures that could affect the operation of the equipment. If this happens the telephone company will provide advance notice in order for you to make necessary modifications to maintain uninterrupted service.

If you have problems with this product and require technical or customer support, please visit www.epson.com for more information.

This product is not intended to be repaired by the customer. If you experience trouble connecting this equipment to a telephone line, please contact:

Name: Epson America, Inc.

Address: 3840 Kilroy Airport Way, Long Beach, CA 90806 U.S.A.

Telephone: (562) 981-3840

If the equipment is causing harm to the telephone network, the telephone company may request that you disconnect the equipment until the problem is resolved.

This equipment may not be used on coin service provided by the telephone company. Connection to party line service is subject to state tariffs. Contact the state public utility commission, public service commission or corporation commission for information.

If your home has specially wired alarm equipment connected to the telephone line, ensure the installation of this equipment does not disable your alarm equipment. If you have questions about what will disable alarm equipment, consult your telephone company or a qualified installer.

The Telephone Consumer Protection Act of 1991 makes it unlawful for any person to use a computer or other electronic device, including fax machines, to send any message unless such message clearly contains in a margin at the top or bottom of each transmitted page or on the first page of the transmission, the date and time it is sent and an identification of the business or other entity, or other individual sending the message and the telephone number of the sending machine or such business, other entity, or individual. (The telephone number provided may not be a 900 number or any other number for which charges exceed local or long-distance transmission charges.)

In order to program this information into your fax machine, click the link below for instructions on entering fax header information.

According to the FCC's electrical safety advisory, we recommend that you may install an AC surge arrester in the AC outlet to which this equipment is connected. Telephone companies report that electrical surges, typically lightning transients, are very destructive to customer terminal equipment connected to AC power sources and that this is a major nationwide problem.

This equipment has been tested and found to comply with the limits for a Class B digital device, pursuant to Part 15 of the FCC Rules. These limits are designed to provide reasonable protection against harmful interference in a residential installation. This equipment generates, uses, and can radiate radio frequency energy and, if not installed and used in accordance with the instructions, may cause harmful interference to radio or television reception. However, there is no guarantee that interference will not occur in a particular installation. If this equipment does cause interference to radio and television reception, which can be determined by turning the equipment off and on, the user is encouraged to try to correct the interference by one or more of the following measures:

- Reorient or relocate the receiving antenna.
- Increase the separation between the equipment and receiver.
- Connect the equipment into an outlet on a circuit different from that to which the receiver is connected.
- Consult the dealer or an experienced radio/TV technician for help.

WARNING

The connection of a non-shielded equipment interface cable to this equipment will invalidate the FCC Certification or Declaration of this device and may cause interference levels which exceed the limits established by the FCC for this equipment. It is the responsibility of the user to obtain and use a shielded equipment interface cable with this device. If this equipment has more than one interface connector, do not leave cables connected to unused interfaces. Changes or modifications not expressly approved by the manufacturer could void the user's authority to operate the equipment.

For Canadian Users

1. This product meets the applicable Industry Canada technical specifications.
2. The Ringer Equivalence Number is an indication of the maximum number of devices allowed to be connected to a telephone interface. The termination on an interface may consist of any combination of devices subject only to the requirement that the sum of the RENs of all the devices does not exceed five.

CAN ICES-3(B)/NMB-3(B)

Le présent matériel est conforme aux spécifications techniques applicables d'Industrie Canada.

L'indice d'équivalence de la sonnerie (IES) sert à indiquer le nombre maximal de terminaux qui peuvent être raccordés à une interface téléphonique. La terminaison d'une interface peut consister en une combinaison quelconque de dispositifs, à la seule condition que la somme d'indices d'équivalence de la sonnerie de tous les dispositifs n'excède pas 5.

CAN ICES-3(B)/NMB-3(B)

Parent topic: [Notices](#)

Related topics

[Setting Up Fax Features Using the Product Control Panel](#)

Trademarks

EPSON® is a registered trademark, EPSON Exceed Your Vision is a registered logomark, and Epson Connect™ is a trademark of Seiko Epson Corporation.

Epson iPrint™ and Remote Print™ are trademarks of Seiko Epson Corporation.

Apple, iPad, iPhone, iPod touch, Mac, and OS X are trademarks of Apple Inc., registered in the U.S. and other countries. AirPrint and the AirPrint logo are trademarks of Apple Inc.

Google® is a registered trademark and Android™, Chromebook™, Gmail™, Google Chrome™, Google Cloud Print™, and Google Drive™ are trademarks of Google Inc.

Wi-Fi Direct® is a registered trademark of Wi-Fi Alliance®.

General Notice: Other product names used herein are for identification purposes only and may be trademarks of their respective owners. Epson disclaims any and all rights in those marks.



Parent topic: [Notices](#)

Copyright Notice

All rights reserved. No part of this publication may be reproduced, stored in a retrieval system, or transmitted in any form or by any means, electronic, mechanical, photocopying, recording, or otherwise, without the prior written permission of Seiko Epson Corporation. The information contained herein is designed only for use with this Epson product. Epson is not responsible for any use of this information as applied to other products.

Neither Seiko Epson Corporation nor its affiliates shall be liable to the purchaser of this product or third parties for damages, losses, costs, or expenses incurred by purchaser or third parties as a result of: accident, misuse, or abuse of this product or unauthorized modifications, repairs, or alterations to this product, or (excluding the U.S.) failure to strictly comply with Seiko Epson Corporation's operating and maintenance instructions.

Seiko Epson Corporation shall not be liable for any damages or problems arising from the use of any options or any consumable products other than those designated as Original Epson Products or Epson Approved Products by Seiko Epson Corporation.

Seiko Epson Corporation shall not be held liable for any damage resulting from electromagnetic interference that occurs from the use of any interface cables other than those designated as Epson approved Products by Seiko Epson Corporation.

This information is subject to change without notice.

[A Note Concerning Responsible Use of Copyrighted Materials](#)

[Default Delay Times for Power Management for Epson Products](#)

[Copyright Attribution](#)

Parent topic: [Notices](#)

A Note Concerning Responsible Use of Copyrighted Materials

Epson encourages each user to be responsible and respectful of the copyright laws when using any Epson product. While some countries' laws permit limited copying or reuse of copyrighted material in

certain circumstances, those circumstances may not be as broad as some people assume. Contact your legal advisor for any questions regarding copyright law.

Parent topic: [Copyright Notice](#)

Default Delay Times for Power Management for Epson Products

This product will enter sleep mode after a period of nonuse. This is to ensure that the product meets Energy Star standards of energy efficiency. More energy savings can be achieved by setting the time to sleep to a shorter interval.

Parent topic: [Copyright Notice](#)

Copyright Attribution

© 2015 Epson America, Inc.

9/15

CPD-42924R1

Parent topic: [Copyright Notice](#)