

Back-UPS[®] Pro 1200/1500 230V Installation and Operation

Inventory

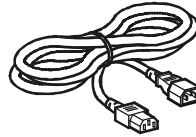

Safety

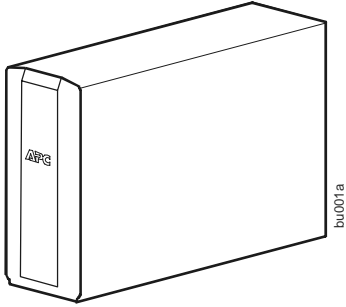
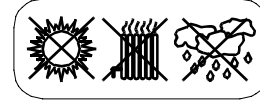

Do not install the Back-UPS in direct sunlight, in excessive heat, humidity, or in contact with fluids.

Connect the battery

1

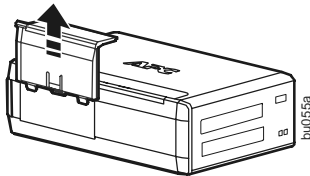

2

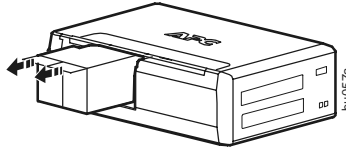

3

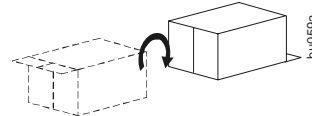

4

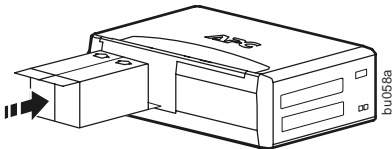

5

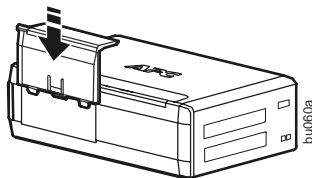

Install PowerChute[®] Personal Edition Software

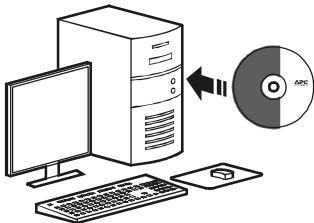

APC PowerChute Personal Edition software provides automatic file saving and shutdown of your computer in the event of a power failure. Use the cable supplied with the Back-UPS to connect the data port on the Back-UPS to the USB port on your computer. Place the CD into your computer, and follow the on-screen instructions.

Connect the equipment

Battery Backup and Surge Protected outlets

When the Back-UPS is receiving input power, the Battery Backup with Surge Protection outlets will supply power to connected equipment. During a power outage or other utility problems, the Battery Backup outlets receive power for a limited time from the Back-UPS.

Connect equipment such as printers, fax machines, scanners, or other peripherals that do not need battery backup power to the Surge Protection Only outlets. These outlets provide full-time protection from surges even if the Back-UPS is switched OFF.

Master and Controlled outlets

To conserve electricity, when the device connected to Master Outlet goes into Sleep or Standby mode, or turns Off, the Controlled device(s) will shut down as well, saving electricity.

Connect a master device, such as a desktop computer or audio/visual receiver to the Master outlet. Connect peripheral devices such as a printer, speakers, or a scanner to the Controlled outlets.

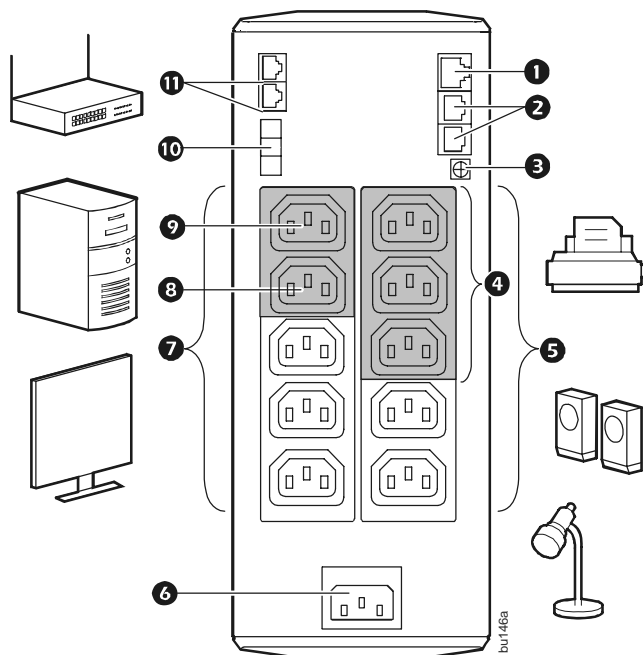

1 USB and Serial Data port	To use PowerChute Personal Edition, connect a serial cable or USB cable.
2 Telephone cable surge-protected ports	Connect a telephone cable to the IN port, and connect a modem to the OUT port.
3 Ground screw	Connect the ground lead of additional surge suppression devices such as network and data line surge protectors.
4 Surge Protected outlets, controlled by the Master outlet	These outlets are protected from electrical surges, and will disconnect from utility power during a power outage, or if the Master device goes into Sleep or Standby mode.
5 Surge Protected outlets	These outlets provide full-time protection from surges, even if the Back-UPS is off. Connect equipment such as printers and scanners that do not require battery backup protection.
6 AC power outlet	Connect the unit to utility power, use the supplied power cord.
7 Battery Backup outlets with Surge Protection	During a power outage or other utility problems, the Battery Backup outlets receive power for a limited time from the Back-UPS. Connect critical equipment such as desktop computer, computer monitor, modem or other data sensitive devices into these outlets.
8 Battery Backup outlet with Surge Protection, controlled by the Master outlet	These outlets will supply battery power to the connected equipment during a power outage. Power will be disconnected to these outlets if the Master device goes into Sleep or Standby mode. Connect equipment such as a computer monitor to these outlets.
9 Master outlet	Connect the master device to this outlet, in most scenarios, this will be the main computer.
10 External Battery Pack connector (BR1500GI only)	Connect an external battery pack to provide additional battery backup runtime (Back-UPS Pro 1500 only).
11 In & Out Ethernet surge-protected ports	Use an ethernet cable to connect a cable modem to the IN port, and connect a computer to the OUT port.

Operation

Power-Saving Function



To conserve electricity, configure the Back-UPS to recognize a Master device, such as a desktop computer or an A/V receiver, and Controlled peripheral devices, such as a printer, speakers, or a scanner. When the Master device goes into Sleep or Standby mode, or is switched OFF, the Controlled device(s) will be switched off as well, saving electricity.

Enable the Power-Saving function. Press and hold MUTE and DISPLAY simultaneously for two seconds. The Back-UPS will beep to indicate that the feature is enabled. The leaf icon on the display will illuminate.

Disable the Power-Saving function. Press and hold MUTE and DISPLAY simultaneously for two seconds. The Back-UPS will beep to indicate that the feature is disabled. The leaf icon on the display will darken.

Setting the threshold. The amount of power used by a device in Sleep or Standby mode varies between devices. It may be necessary to adjust the threshold at which the Master outlet signals the Controlled outlets to shut down.

1. Ensure a master device is connected to the Master outlet. Put that device into Sleep or Standby mode, or turn it OFF.
2. Press DISPLAY and MUTE simultaneously and hold for six seconds, until the leaf icon flashes three times and the Back-UPS beeps three times.
3. The Back-UPS will now recognize the threshold level of the Master device and save it as the new threshold setting.

Power-Saving Display

The display interface can be configured to be continuously illuminated, or to save energy, it can be configured to darken after a period of inactivity.

1. Full Time Mode: Press and hold DISPLAY for two seconds. The display will illuminate and the Back-UPS will beep to confirm the Full-Time mode.
2. Power-Saving Mode: Press and hold DISPLAY for two seconds. The display will darken and the Back-UPS will beep to confirm the Power-Saving mode. While in Power-Saving Mode, the display will illuminate if a button is pressed, it then darkens after 60 seconds of no activity.

Unit sensitivity

Adjust the sensitivity of the Back-UPS to control when it will switch to battery power; the higher the sensitivity, the more often the Back-UPS will switch to battery power.

1. Ensure the Back-UPS is connected to utility power, but is OFF.
2. Press and hold the POWER button for six seconds. The LOAD CAPACITY bar will flash on and off, indicating that the Back-UPS is in programming mode.
3. Press POWER again to rotate through the menu options. Stop at selected sensitivity. The Back-UPS will beep to confirm the selection.

Low sensitivity



156-300 Vac

Input voltage is extremely low or high. (Not recommended for computer loads.)

Medium sensitivity (Default)



176-294 Vac

The Back-UPS frequently switches to battery power.

High sensitivity



176-288 Vac

The connected equipment is sensitive to voltage fluctuations.

Front Panel Buttons and Display Interface

Use the three buttons on the front panel of the Back-UPS and the display interface to configure the Back-UPS.

Front panel

- ❶ Mute button
- ❷ Power On/Off button
- ❸ Display button
- ❹ Display interface

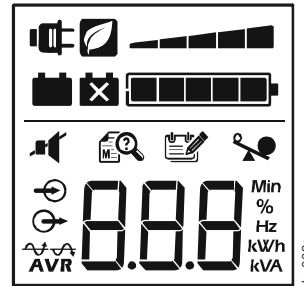
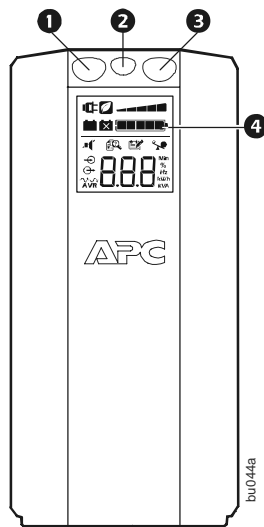

On Line—The Back-UPS is supplying conditioned utility power to connected equipment



Power-Saving—Master and Controlled outlets are enabled, saving power when the master device goes into sleep or standby mode



Load Capacity—The load is indicated by the number of sections illuminated, one to five. Each bar represents 20% of the load.



Battery Charge—The battery charge level is indicated by the number of sections illuminated. When all five blocks are illuminated, the Back-UPS is at full charge. When one block is filled, the Back-UPS is near the end of its battery capacity, the indicator will flash and the Back-UPS will beep continuously.



Overload—The power demand from the load has exceeded the capacity of the Back-UPS.



Event—The event counter shows the number of events that occurred that caused the Back-UPS to switch to on-battery operation.



Automatic Voltage Regulation—The Back-UPS can compensate for high or low input voltage.



When illuminated, the Back-UPS is compensating for low input voltage.



When illuminated, the Back-UPS is compensating for high input voltage.



Input voltage.



Output voltage.



System Faults—The system has a fault. The fault number will illuminate on the display interface. See “System Faults” on page 5.



Mute—If the line through the speaker icon is illuminated, the audible alarm has been turned off.



Replace Battery—The battery is not connected or is nearing the end of its useful life. Replace the battery.



On Battery—The Back-UPS is supplying battery backup power to the connected equipment, it will beep four times every 30 seconds.

Warnings and System Faults

Audible Warnings

Four Beeps Every 30 Seconds	Back-UPS is running on battery. You should consider saving any work in progress.
Continuous Beeping	Low battery condition and battery run-time is very low. Promptly save any work in progress, exit all open applications, and shut down the operating system.
Continuous tone	Battery Backup outputs are overloaded.
Chirps for 1 Minute every 5 hours	Battery fails the automatic diagnostic test and should be replaced.

Warning Icons

If these icons are illuminated...

This may be the problem.

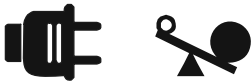

The Back-UPS is operating on utility power, but is overloaded. Disconnect one of the items connected to the Back-UPS. If the Overload icon stops flashing, the Back-UPS is no longer overloaded and will continue to operate normally.



The Back-UPS is operating on battery power, but is overloaded. Disconnect one of the items connected to the Back-UPS. If the Overload icon stops flashing, the Back-UPS is no longer overloaded and will continue to operate normally.



The Back-UPS is operating on utility power, but the battery is not functioning properly. Contact APC Customer Service to order a replacement battery. See "Replacement Battery" on page 8.



The Back-UPS is operating on battery power and the battery power is getting low. Shut down all connected equipment to avoid losing an unsaved data. When possible, connect the Back-UPS to utility power to recharge the batter.





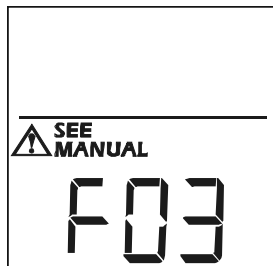







System Faults

The Back-UPS will display these fault messages. For faults F01 and F02, contact APC Technical Support.



F01	On-Battery Overload	Turn the Back-UPS off. Disconnect non-essential equipment from the Battery Backup outlets and the turn Back-UPS on.
F02	On-Battery Output Short	Turn the Back-UPS off. Disconnect non-essential equipment from the Battery Backup outlets and the turn Back-UPS on.
F03	On-Battery Xcap Overload	
F04	Clamp Short	
F05	Charge Fault	
F06	Relay Welding	Faults F03-F09 cannot be corrected by the user, contact APC Technical Support for assistance.
F07	Temperature	
F08	Fan Fault	
F09	Internal Fault	

Function Button Quick-Reference

Function	Button	Timing (seconds)	UPS Status	Description
Power				
Power On		0.2	Off	Press POWER to start receiving input utility power. If A/C input power is not available, the Back-UPS will run on battery power.
Power Off		2	On	The Back-UPS is not receiving input utility power, but is providing surge protection.
Display				
Status Inquiry		0.2	On	Verify the status or condition of the Back-UPS. The LCD will illuminate for 60 seconds.
Full-Time/Power-Saving mode		2	On	The LCD will illuminate and the Back-UPS will beep to confirm the Full-Time mode. The LCD will darken and the Back-UPS will beep to confirm the Power-Saving mode. While in Power-Saving Mode, the LCD will illuminate if a button is pressed, then darkens after 60 seconds of no activity.
Mute				
Event Specific		0.2	On	Disable any audible alarms caused by an event.
General Status Enable/Disable		2	On	Enable or disable the audible alarms. The Mute icon will illuminate and the Back-UPS will beep one time. The Mute function will not activate unless the Back-UPS is operating on battery power.
Sensitivity				
Sensitivity		6	Off	The Load Capacity icon will blink, indicating that the Back-UPS is in programming mode. Use the POWER button to scroll through Low, Medium, and High, stop at selected sensitivity. The Back-UPS will beep to confirm selection. See Configuration for details.
Master/Controlled outlet Enable/Disable				
Master/Controlled outlet Enable/Disable		2	On	The leaf icon will darken indicating that the Master Outlet feature is disabled or illuminate to indicate the Master Outlet feature is enabled. The Back-UPS will beep once.
Master/Enable Threshold Calibration				
Master/Enable Threshold Calibration		6	On	While calibrating the threshold setting, the device connected to the Master Outlet should be turned off or placed in Standby or Sleep mode. Upon completion, Power-Saving icon will flash 3 and beep 3 times.
Self-Test (manual)				
Self-Test (manual)		6	On	The Back-UPS will perform a test of the internal battery. Note: This will happen automatically when the Back-UPS is turned ON.
Event Reset				
Event Reset		0.2	On	When the Event screen is visible, press and hold DISPLAY, then press POWER, to clear the utility failure event counter.
Fault Reset				
Fault Reset		2	Fault	After a fault has been identified, press POWER to remove the visual indication and return to standby status.

Troubleshooting

Problem	Possible Cause	Corrective Action
Back-UPS will not switch on.	The Back-UPS is not connected to utility power.	Ensure that the Back-UPS is securely connected to an AC outlet.
	The circuit breaker has been tripped.	Disconnect non-essential equipment from the Back-UPS. Reset the circuit breaker. Re-connect equipment one item at a time. If the circuit breaker is tripped again, disconnect the device that caused the trip.
	The internal battery is not connected.	Connect the battery.
	The utility input voltage is out of range.	Adjust the transfer voltage and sensitivity range.
The Back-UPS does not provide power during a utility power outage.	Ensure that essential equipment is not plugged into a SURGE ONLY outlet.	Disconnect equipment from the SURGE ONLY outlet and re-connect to a Battery Backup outlet.
The Back-UPS is operating on battery power, while connected to utility power.	The plug has partially pulled out of the wall outlet, the wall outlet is no longer receiving utility power, or the circuit breaker has been tripped.	Ensure that the plug is fully inserted into the wall outlet. Ensure that the wall outlet is receiving utility power by checking it with another device.
	The Back-UPS is performing an automatic self test.	No action is necessary.
	The utility input voltage is out of range, the frequency is out of range, or the waveform is distorted.	Adjust the transfer voltage and sensitivity range.
The Back-UPS does not provide the expected amount of backup time.	Battery Backup outlets may be fully or improperly loaded.	Disconnect non-essential equipment from the Battery Backup outlets and connect the equipment to SURGE ONLY outlets.
	The battery was recently discharged due to a power outage and has not fully recharged.	Charge the battery cartridge for 16 hours.
	The battery has reached the end of its useful life.	Replace the battery.
The REPLACE BATTERY indicator is illuminated.	The battery has reached the end of its useful life.	Replace the battery.
The OVERLOAD indicator is illuminated.	The equipment connected to the Back-UPS is drawing more power than the Back-UPS can provide.	Disconnect non-essential equipment from the Battery Backup outlets and connect the equipment to SURGE ONLY outlets.
The SYSTEM FAULT indicator is illuminated, all the front panel indicators are flashing.	There is an internal fault.	Determine which internal fault message is displayed by matching the number displayed on the LCD with the corresponding Fault Message (see System Faults) and contact APC Technical Support.
Power is not supplied to some outlets.	Power to the Controlled outlets has intentionally been turned off.	Confirm that the correct peripherals are connected to Controlled outlets. If this feature is not desired, disable the Power-Saving Master and Controlled outlets.
The Controlled outlets are not supplying power, even though the Master device is not in sleep mode.	The Master Outlet threshold may be incorrectly set.	Adjust the threshold when the Master outlet signals the Controlled outlets to shut down.

Specifications

Model	BR1200GI	BR1500GI
VA	1200 VA	1500 VA
Maximum Load	720 W	865 W
Nominal Input Voltage	230 V	
Online Input Voltage Range	176 - 294 V	
Automatic Voltage Regulation	(188-216) +11.2% (252-282) -11.2%	
Frequency Range	50/60 Hz ± 1 Hz	
On-battery Waveshape	Step-approximated sine-wave	
Typical Recharge Time	8 hours	
Transfer Time	10 ms, maximum	
Operating Temperature	0° to 40°C (32° to 104°F)	
Storage Temperature	-15° to 45°C (23° to 113°F)	
Unit Dimensions	30.1 × 11.2 × 38.2 cm (11.9 × 4.4 × 15.0 in)	
Unit Weight	12.8 kg (28.2 lbs)	13.4 kg (29.5 lbs)
Interface	Serial, USB	
On-Battery Runtime	Go to: www.apc.com	
EMI Classification	CE, C-Tick, KETI	
Approvals	CE, TUV-GS, GOST, A-Tick, KETI, TISI	

Replacement Battery

The battery cartridge typically lasts 3 to 6 years, a shorter period if subjected to frequent outages or elevated temperatures. Battery replacement part for Back-UPS Pro 1200 and 1500 is APCRBC124. Please recycle spent battery cartridges.

Service

If the Back-UPS arrived damaged, notify the carrier.

If the Back-UPS requires service, do not return it to the dealer.

1. Consult the Troubleshooting section to eliminate common problems.
2. If the problem persists, go to <http://www.apc.com/support/>.
3. If the problem still persists, contact APC Technical Support. Have the Back-UPS model number, serial number and date of purchase available. Be prepared to troubleshoot the problem with an APC Technical Support representative.

If this is not successful, APC will issue a Return Merchandise Authorization (RMA) number and a shipping address.

Warranty

The standard warranty is three (3) years from the date of purchase, valid in European Community. For all other regions, the standard warranty is two (2) years from the date of purchase. APC's standard procedure is to replace the original unit with a factory reconditioned unit.

Customers who must have the original unit back due to the assignment of asset tags and set depreciation schedules must declare such a need at first contact with an APC Technical Support representative. APC will ship the replacement unit once the defective unit has been received by the repair department, or cross-ship upon the receipt of a valid credit card number. The customer pays for shipping the unit to APC. APC pays ground freight transportation costs to ship the replacement unit to the customer.

APC Worldwide Customer Support

Internet	http://www.apc.com
Worldwide	+1 888 272-3858

Customer support and warranty information is available at the APC Web site, www.apc.com.