

# User Guide



# HP OfficeJet 250



# HP OfficeJet 250 Mobile All-in-One series

User Guide

**Copyright information**

© Copyright 2016 HP Development Company, L.P.

Edition 1, 3/2016

**HP Company notices**

The information contained in this document is subject to change without notice.

All rights reserved. Reproduction, adaptation, or translation of this material is prohibited without prior written permission of HP, except as allowed under copyright laws.

The only warranties for HP products and services are set forth in the express warranty statements accompanying such products and services. Nothing herein should be construed as constituting an additional warranty. HP shall not be liable for technical or editorial errors or omissions contained herein.

**Acknowledgements**

Microsoft and Windows are either registered trademarks or trademarks of Microsoft Corporation in the United States and/or other countries.

ENERGY STAR and the ENERGY STAR mark are registered trademarks owned by the U.S. Environmental Protection Agency.

Mac, OS X, and AirPrint are trademarks of Apple Inc., registered in the U.S. and other countries.

## Safety information



Always follow basic safety precautions when using this product to reduce risk of injury from fire or electric shock.

- Read and understand all instructions in the documentation that comes with the printer.
- Observe all warnings and instructions marked on the product.
- Unplug the printer from wall outlet and remove battery pack before cleaning.
- Do not install or use this product near water, or when you are wet.
- Install the product securely on a stable surface.
- Install the product in a protected location where no one can step on or trip over the line cord, and the line cord cannot be damaged.
- If the product does not operate normally, see [Solve a problem](#).
- There are no user-serviceable parts inside. Refer servicing to qualified service personnel.
- Use only the battery pack supplied or sold by HP for this printer.



---

# Table of contents

<b>1 How do I?</b> .....	<b>1</b>
<b>2 Get started</b> .....	<b>2</b>
Accessibility .....	2
HP EcoSolutions (HP and the Environment) .....	3
Manage power .....	3
Sleep mode .....	3
Auto-Off .....	3
Quiet Mode .....	4
Optimize Printing Supplies .....	5
Understand the printer parts .....	5
Front and side view .....	5
Document feeder .....	6
Printing supplies area .....	7
Back view .....	7
Use the printer control panel .....	7
Lift the printer control panel .....	8
Overview of buttons .....	8
Printer control panel display icons .....	9
Function tabs .....	10
Use the Home screen .....	10
Change printer settings .....	10
Dashboard .....	11
Use shortcuts .....	11
Paper basics .....	11
Recommended papers for printing .....	12
Order HP paper supplies .....	13
Tips for selecting and using paper .....	13
Load paper .....	14
Load an original in the document feeder .....	16
Automatic Paper Size Detection .....	17
Update the printer .....	17
Use the printer battery .....	18
Install or replace the battery .....	18
Check the battery status .....	19
To check battery status from the battery .....	19

To check battery status from the printer control panel .....	19
Battery status .....	19
Charge the battery .....	20
Store the battery .....	20
Dispose the used battery .....	21
Open the HP printer software (Windows) .....	21
Turn the printer off .....	21

### **3 Print ..... 22**

Print documents .....	22
Print brochures .....	23
Print on envelopes .....	24
Print photos .....	25
Print on special and custom-size paper .....	26
Print on both sides (manually) .....	28
Print with mobile devices .....	29
Print from mobile devices .....	29
Access printer features and troubleshooting information from mobile devices .....	30
Tips for print success .....	30

### **4 Copy and scan ..... 33**

Copy .....	33
Scan .....	34
Scan to a computer .....	34
Scan to a USB .....	36
Scan to email .....	36
Set up Scan to Email .....	36
Scan a document or photo to email .....	37
Change account settings .....	38
Scanning documents as editable text .....	38
Scan documents as editable text .....	38
Guidelines for scanning documents as editable text .....	39
Create a new scan shortcut (Windows) .....	40
Change scan settings (Windows) .....	40
Tips for copy and scan success .....	41

### **5 Web services ..... 42**

What are Web Services? .....	42
Set up Web Services .....	42
Use Web Services .....	44

HP ePrint .....	44
Print apps .....	44
Remove Web Services .....	45
<b>6 Work with cartridges .....</b>	<b>46</b>
Information about Cartridges .....	46
Check the estimated ink levels .....	46
Printing with black or color ink only .....	47
Replace the cartridges .....	47
Order the cartridges .....	49
Store printing supplies .....	49
Cartridge warranty information .....	49
<b>7 Network setup .....</b>	<b>50</b>
Set up the printer for wireless communication .....	50
Before you begin .....	50
Set up the printer on your wireless network .....	51
Change the connection type .....	51
Test the wireless connection .....	52
Turn on or off the wireless capability of the printer .....	52
Change network settings .....	52
Use Wi-Fi Direct .....	53
Easily connect and print with Bluetooth® Smart .....	56
<b>8 Printer management tools .....</b>	<b>57</b>
Toolbox (Windows) .....	57
HP Utility (OS X) .....	57
Embedded web server .....	57
About cookies .....	58
Open the embedded web server .....	58
Embedded web server cannot be opened .....	59
<b>9 Solve a problem .....</b>	<b>60</b>
Jams and paper-feed issues .....	60
Clear a paper jam .....	60
Read general instructions in the Help for clearing paper jams .....	60
Learn how to avoid paper jams .....	62
Solve paper-feed problems .....	63
Printing issues .....	63
Fix problems with page not printing (unable to print) .....	63



Read general instructions in the Help for unable to print issues .....	63
Fix print quality issues .....	68
Read general instructions in the Help for resolving print quality issues .....	68
Copy issues .....	71
Scan issues .....	71
Network and connection issues .....	71
Fix wireless connection .....	71
Find network settings for wireless connection .....	72
Fix Wi-Fi Direct connection .....	72
Printer hardware issues .....	73
Get help from the printer control panel .....	73
Understand printer reports .....	74
Printer status report .....	74
Network configuration page .....	74
Print quality report .....	74
Solve problems using Web Services .....	74
Maintain the printer .....	75
Clean the exterior .....	75
Clean the document feeder .....	75
Maintain the cartridge and printer .....	76
Restore original factory defaults and settings .....	77
HP support .....	78
<b>Appendix A Technical information .....</b>	<b>80</b>
Specifications .....	80
Regulatory information .....	81
Regulatory Model Number .....	82
FCC statement .....	82
VCCI (Class B) compliance statement for users in Japan .....	83
Notice to users in Japan about the power cord .....	83
Notice to users in Korea .....	83
Noise emission statement for Germany .....	83
European Union Regulatory Notice .....	83
Products with wireless functionality .....	83
Visual display workplaces statement for Germany .....	84
Declaration of conformity .....	85
Regulatory information for wireless products .....	86
Exposure to radio frequency radiation .....	86
Notice to users in Canada .....	87
Notice to users in Taiwan .....	87
Notice to users in Japan .....	87

Notice to users in Korea .....	88
Environmental product stewardship program .....	88
Eco-Tips .....	88
European Union Commission Regulation 1275/2008 .....	89
Paper .....	89
Plastics .....	89
Material safety data sheets .....	89
Recycling program .....	89
HP inkjet supplies recycling program .....	89
Power consumption .....	89
Disposal of waste equipment by users .....	90
Chemical substances .....	90
Restriction of hazardous substance (Ukraine) .....	90
Restriction of hazardous substance (India) .....	90
China SEPA Eco Label User Information .....	90
China Energy Label for Printer, Fax and Copier .....	91
The Table of Hazardous Substances/Elements and their Content (China) .....	92
EPEAT .....	92
Battery disposal in Taiwan .....	92
EU Battery Directive .....	93
California Rechargeable Battery Take-back Notice .....	94
United States Call2Recycle (RBRC) .....	94

<b>Index .....</b>	<b>95</b>
--------------------	-----------



---

# 1 How do I?

- [Get started](#)
- [Print](#)
- [Copy and scan](#)
- [Web services](#)
- [Work with cartridges](#)
- [Solve a problem](#)

---

## 2 Get started

This guide provides details about how to use the printer and how to resolve problems.

- [Accessibility](#)
- [HP EcoSolutions \(HP and the Environment\)](#)
- [Understand the printer parts](#)
- [Use the printer control panel](#)
- [Paper basics](#)
- [Load paper](#)
- [Load an original in the document feeder](#)
- [Automatic Paper Size Detection](#)
- [Update the printer](#)
- [Use the printer battery](#)
- [Open the HP printer software \(Windows\)](#)
- [Turn the printer off](#)

### Accessibility

The printer provides a number of features that make it accessible for people with disabilities.

#### Visual

The HP software provided with the printer is accessible for users with visual impairments or low vision by using your operating system's accessibility options and features. The software also supports most assistive technology such as screen readers, Braille readers, and voice-to-text applications. For users who are color blind, colored buttons and tabs used in the HP software have simple text or icon labels that convey the appropriate action.

#### Mobility

For users with mobility impairments, the HP software functions can be executed through keyboard commands. The HP software also supports Windows accessibility options such as StickyKeys, ToggleKeys, FilterKeys, and MouseKeys. The printer doors, buttons, paper trays, and paper-width guides can be operated by users with limited strength and reach.

#### Support

For more information about accessibility solutions for HP products, visit the HP Accessibility and Aging website ([www.hp.com/accessibility](http://www.hp.com/accessibility)).

For accessibility information for OS X, visit the Apple website at [www.apple.com/accessibility](http://www.apple.com/accessibility).

# HP EcoSolutions (HP and the Environment)

HP is committed to helping you optimize your environmental footprint and empowering you to print responsibly—at home or in the office.

For more detailed information about environmental guidelines that HP follows during the manufacturing process, see [Environmental product stewardship program](#). For more information about HP's environmental initiatives, visit [www.hp.com/ecosolutions](http://www.hp.com/ecosolutions).

- [Manage power](#)
- [Quiet Mode](#)
- [Optimize Printing Supplies](#)

## Manage power

Use **Sleep Mode** and **Auto-Off** to conserve electricity.

### Sleep mode

Power usage is reduced while in Sleep mode. After initial setup of printer, the printer will enter Sleep mode after five minutes of inactivity.

1. From the printer control panel, touch or swipe down the tab at the top of the screen to open the Dashboard, touch  (**EcoSolution**).
2. Touch **Sleep Mode**, and then touch the desired option.

### Auto-Off

This feature turns the printer off after 15 minutes of inactivity to help reduce energy use. Auto-Off turns the printer off completely, so you must use the Power button to turn the printer back on.

If your printer supports this energy saving feature, Auto-Off is automatically enabled or disabled depending on printer capabilities and connection options. Even when Auto-Off is disabled, the printer enters Sleep mode after 5 minutes of inactivity to help reduce energy use

- Auto-Off is enabled when the printer is turned on, if the printer does not have network, fax or Wi-Fi Direct capability, or is not using these capabilities.
- Auto-Off is disabled when a printer's wireless or Wi-Fi Direct capability is turned on or when a printer with fax, USB, or Ethernet network capability establishes a fax, USB, or Ethernet network connection.

---

 **TIP:** To conserve battery power, you can enable Auto-Off, even when the printer is connected or wireless is turned on.

---

### To manually enable Auto-Off from the HP printer software

1. Connect the printer to your computer if they are disconnected.
2. Launch the printer software installed on your computer.
3. From the software, click **Print** on the toolbar and select **Maintain Your Printer**.  
A toolbox window opens.
4. From the **Advanced Settings** tab, select **Change** for the Auto-Off option.

5. From the time period list, select one for Auto-Off inactivity time and then click **OK**.
6. Click **Yes** when prompted.  
Auto-Off is enabled.

### To manually enable Auto-Off from the printer control panel

1. From the printer control panel, touch or swipe down the tab at the top of the screen to open the Dashboard, and then touch  (**Setup**).
2. Touch **Power Management**, and then **Auto-Off**.
3. Choose an inactivity time period from the list.  
A messages shows up, prompting you whether to always enable Auto-Off.
4. Touch **Yes**.  
Auto-Off is enabled.

## Quiet Mode

Quiet Mode slows down printing to reduce overall noise without affecting print quality. It only works for printing with normal print quality on plain paper. Quiet Mode is off by default.

To reduce printing noise, turn on Quiet Mode.

To print at normal speed, turn off Quiet Mode.



---

**NOTE:** Quiet Mode does not work if you print photos or envelopes.

---

### To turn on Quiet Mode from the printer control panel

1. From the printer control panel, touch or swipe down the tab at the top of the screen to open the Dashboard, and then touch  (**Setup**).
2. Touch **Quiet Mode**.
3. Touch **Off** next to **Quiet Mode** to turn it on.

### To turn Quiet Mode on or off from the printer software (Windows)

1. Open the HP printer software. For more information, see [Open the HP printer software \(Windows\)](#).
2. Click **Quiet Mode**.
3. Select **On** or **Off**.
4. Click **Save Settings**.
5. Click **OK**.

### To turn Quiet Mode on or off from the printer software (OS X)

1. Open HP Utility.  
 **NOTE:** HP Utility is located in the **HP** folder in the **Applications** folder.
2. Select the printer.
3. Click **Quiet Mode**.

4. Select **On** or **Off**.
5. Click **Apply Now**.

#### To turn Quiet Mode on or off from the Embedded Web Server (EWS)

1. Open the EWS. For more information, see [Open the embedded web server](#).
2. Click the **Settings** tab.
3. In the **Preferences** section, select **Quiet Mode**, and then select **On** or **Off**.
4. Click **Apply**.

## Optimize Printing Supplies

To optimize printing supplies such as cartridge and paper, try the following:

- Recycle used original HP cartridges through HP Planet Partners.  
For more information, visit [www.hp.com/recycle](http://www.hp.com/recycle).
- Optimize paper usage by printing on both sides of the paper.
- Change the print quality in the printer driver to a draft setting. The draft setting uses less ink.
- Only clean the cartridges when needed. Doing so wastes ink and shortens the life of the cartridges.

## Understand the printer parts

This section contains the following topics:

- [Front and side view](#)
- [Document feeder](#)
- [Printing supplies area](#)
- [Back view](#)

### Front and side view

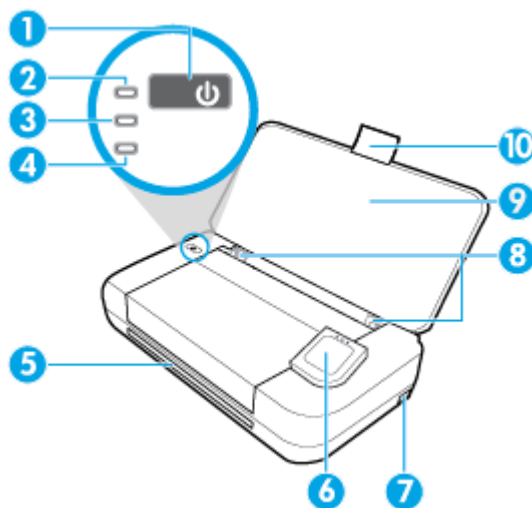

---

1 Power button

---



2	Power light
3	Battery light <ul style="list-style-type: none"> <li>Lights up when the battery installed in the printer is charging.</li> <li>Blinks when there is an issue with the battery, such as the battery is faulty or is too hot or too cold to charge.</li> </ul>
4	Wireless light: Indicates the status of the printer's wireless connection <ul style="list-style-type: none"> <li>Solid blue light: Indicates that wireless connection has been established and you can print.</li> <li>Blinking light: Indicates that the wireless feature needs user action. Refer to the message on the printer display.</li> <li>If the wireless light is off, wireless is turned off.</li> </ul>
5	Output slot
6	Control panel
7	USB host port <ul style="list-style-type: none"> <li>Connects to a USB flash drive so that you can print photos from the drive. For more information on how to print photos from a USB flash drive, see <a href="#">Print photos</a>.</li> <li>When the printer is turned on, it can also be used to charge a mobile device (such as a smart phone) connected to the USB host port.</li> </ul>
8	Input tray paper-width guides
9	Input tray
10	Input tray extension

## Document feeder

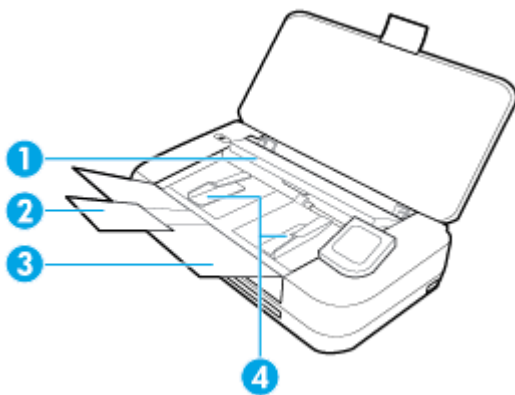

1	Document feeder: Load the original to be copied or scanned
2	Document feeder tray extension
3	Document feeder tray
4	Document feeder paper-width guides

## Printing supplies area

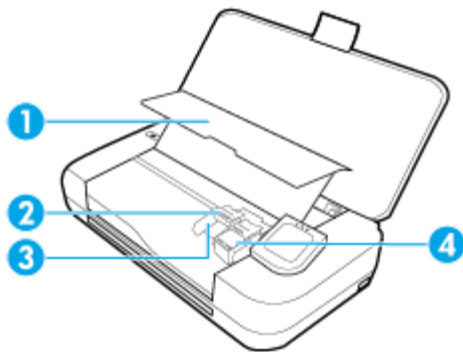

- |   |                       |
|---|-----------------------|
| 1 | Cartridge access door |
| 2 | Cartridge latch       |
| 3 | Cartridge slot        |
| 4 | Cartridge             |

 **NOTE:** Cartridges should be kept in the printer to prevent possible print quality issues or damage. Avoid removing supplies for extended periods of time.

## Back view

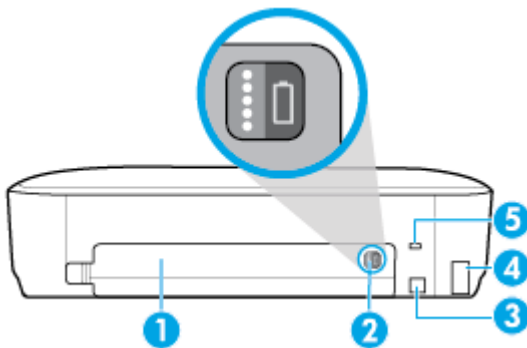

- |   |   |
|---|---|
| 1 | Battery cover   |
| 2 | Battery status button: Press to show the battery status. For more information, see <a href="#">Check the battery status</a> .   |
| 3 | USB port <ul style="list-style-type: none"><li>• Connects the printer to your computer with the USB cable provided.</li><li>• Charges the battery installed in the printer. For more information on charging the battery, see <a href="#">Charge the battery</a>.</li></ul> |
| 4 | Power input   |
| 5 | Security lock slot: Allows you to insert a security cable to lock your printer.   |

## Use the printer control panel

This section contains the following topics:

- [Lift the printer control panel](#)
- [Overview of buttons](#)
- [Printer control panel display icons](#)
- [Function tabs](#)
- [Use the Home screen](#)
- [Change printer settings](#)
- [Dashboard](#)
- [Use shortcuts](#)

## Lift the printer control panel

You can use the printer control panel while it is lying flat, or lift it up for easier viewing and use.

### To lift the printer control panel

- ▲ Press the top of the printer control panel and it rises automatically.

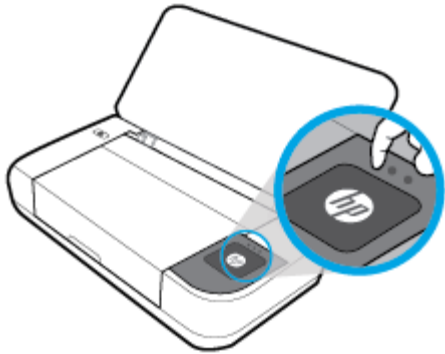

---

 **NOTE:** Return the printer control panel to its original position by pushing down the top side until it clicks into place.

---

## Overview of buttons

The following illustration provides quick reference to the printer control panel features.

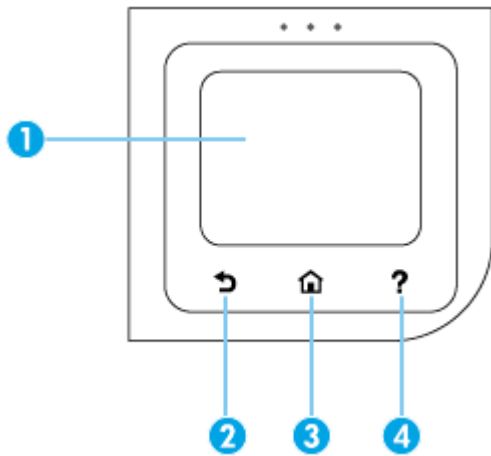



Label	Name and Description
1	<b>Control panel display:</b> Touch the screen to select menu options, or scroll through the menu items. For information about the icons that appear on the display, see <a href="#">Printer control panel display icons</a> .
2	<b>Back button:</b> Returns to the previous screen.
3	<b>Home button:</b> Returns to the home screen from any other screen.
4	<b>Help button:</b> Opens the Help menu when on the Home screen, displays the help for a selected menu option, or provides more information about the current screen.

## Printer control panel display icons

To access the icons, touch or swipe down the tab at the top of a screen to open the Dashboard, and then touch the icon.

Icon	Purpose
	<b>Setup:</b> Allows you to change preferences and other maintenance settings, set up network, Wi-Fi Direct, Web Services, and also generate reports.
	<b>Wireless:</b> Displays wireless status and menu options. For more information, see <a href="#">Set up the printer for wireless communication</a> . <b>NOTE:</b> If the printer's network connection is not set up, the display shows  ( <b>Wireless</b> ) by default.
	<b>HP ePrint:</b> Displays the <b>Web Services Summary</b> menu, where you can check ePrint status details, change ePrint settings, or view the printer email address. For more information, see <a href="#">HP ePrint</a> .
	<b>Wi-Fi Direct:</b> Displays the status, name, and password for Wi-Fi Direct, and the number of devices connected. You can also change settings and print a guide. For more information, see <a href="#">Use Wi-Fi Direct</a> .
	<b>Ink:</b> Displays the estimated ink levels.

Icon	Purpose
	<b>HP EcoSolutions:</b> Displays a screen where you can configure some of the printer's environmental features.
	<b>Battery:</b> Indicates battery level if battery is installed.

## Function tabs

Function tabs are located at the bottom of the screen.

Function tab	Purpose
 (Shortcuts)	Access to shortcuts you have created.
<b>Copy</b>	Copy document.
<b>Scan</b>	Scan document to email, computer or USB flash drive.
<b>Photo</b>	Print photo from USB flash drive.
<b>Apps</b>	Access to the apps for your printer.

## Use the Home screen

The Home screen displays after you touch  (**Home**).

It provides a main menu for you to access the functions offered with the printer.

## Change printer settings

Use the printer control panel to change the printer function and settings, print reports, or get help for the printer.

 **TIP:** If the printer is connected to a computer, you can also change the printer settings using the printer management tools in the software.



For more information about these tools, see [Printer management tools](#).

### To change the printer settings

To change the printer settings or print reports, use the options available on the **Setup** menu.

1. From the printer control panel, touch or swipe down the tab at the top of the screen to open the Dashboard, and then touch  (**Setup**).
2. Touch and scroll through the screens.
3. Touch the screen items to choose options.

---

 **TIP:** Touch  (**Home**) return to the Home screen.

---

## Dashboard

The Dashboard on the printer control panel lets you access the icons on the display, check the status of the printer, or monitor and manage current and scheduled printer tasks.

To open the Dashboard, touch or swipe down the tab  at the top of a screen on the printer control panel.

## Use shortcuts

Using shortcuts on the printer control panel, you can create a collection of the tasks frequently used from all features available in the function folders.

Once shortcuts are created, you can access to them on the Home screen or through the **Shortcuts** tab.

### To create a shortcut

1. Select one of the function tabs.
2. Touch and hold the desired icon until a message is displayed prompting you to drag the icon to the bottom of the control panel display to create a shortcut.
3. Drag the icon to the bottom area of control panel display.
4. After you drop the icon, the shortcut is created.
5. Touch  (**Shortcuts**) to verify that the shortcut works.

### To delete a shortcut

1. Touch  (**Shortcuts**).
2. Touch and hold the desired icon until a message is displayed prompting you to drag the icon to the bottom of the control panel display to delete a shortcut.
3. Drag the icon to the bottom area of control panel display.
4. After you drop the icon, the shortcut is deleted.
5. Verify that the shortcut is deleted.

## Paper basics

The printer is designed to work well with most types of office paper. It is best to test a variety of print paper types before buying large quantities. Use HP paper for optimum print quality. Visit the HP website at [www.hp.com](http://www.hp.com) for more information about HP paper.



HP recommends plain papers with the ColorLok logo for printing everyday documents. All papers with the ColorLok logo are independently tested to meet high standards of reliability and print quality, and produce documents with crisp, vivid color, bolder blacks, and that dry faster than ordinary plain papers. Look for papers with the ColorLok logo in a variety of weights and sizes from major paper manufacturers.

This section contains the following topics:

- [Recommended papers for printing](#)
- [Order HP paper supplies](#)
- [Tips for selecting and using paper](#)

## Recommended papers for printing

If you want the best print quality, HP recommends using HP papers that are specifically designed for the type of project you are printing.

Depending on your country/region, some of these papers might not be available.

### Business documents

- **HP Premium Presentation Paper 120g Matte or HP Professional Paper 120 Matt**

This paper is a heavy two-sided matte paper perfect for presentation, proposals, reports, and newsletters. It is heavy weight for an impressive look and feel.

- **HP Brochure Paper 180g Glossy or HP Professional Paper 180 Glossy**

These papers are glossy-coated on both sides for two-sided use. They are the perfect choice for near-photographic reproductions and business graphics for report covers, special presentations, brochures, mailers, and calendars.

- **HP Brochure Paper 180g Matte or HP Professional Paper 180 Matt**

These papers are matte-coated on both sides for two-sided use. They are the perfect choice for near-photographic reproductions and business graphics for report covers, special presentations, brochures, mailers, and calendars.

### Everyday printing

All the papers listed for everyday printing feature ColorLok Technology for less smearing, bolder blacks, and vivid colors.

- **HP Bright White Inkjet Paper**

HP Bright White Inkjet Paper delivers high-contrast colors and sharp text. It is opaque enough for two-sided color usage with no show-through, which makes it ideal for newsletters, reports, and flyers.

- **HP Printing Paper**

HP Printing Paper is a high-quality multifunction paper. It produces documents that look and feel more substantial than documents printed on standard multipurpose. It is acid-free for longer lasting documents.

- **HP Office Paper**

HP Office Paper is a high-quality multifunction paper. It is suitable for copies, drafts, memos, and other everyday documents. It is acid-free for longer lasting documents.

## Photo printing

- **HP Premium Plus Photo Paper**

HP Premium Plus Photo Paper is HP's highest-quality photo paper for your best photos. With HP Premium Plus Photo Paper, you can print beautiful photos that are instant-dry so you can share them right off the printer. The printer supports several sizes, including A4, 8.5 x 11 inches, 4 x 6 inches (10 x 15 cm), and 5 x 7 inches (13 x 18 cm) in two finishes - glossy or soft gloss (semi-gloss). Ideal for framing, displaying, or gifting your best photos and special photo projects. HP Premium Plus Photo Paper delivers exceptional results with professional quality and durability.

- **HP Advanced Photo Paper**

This glossy photo paper features an instant-dry finish for easy handling without smudging. It resists water, smears, fingerprints, and humidity. Your prints have a look and feel comparable to a store-processed photo. It is available in several sizes, including A4, 8.5 x 11 inches, 10 x 15 cm (4 x 6 inches), 13 x 18 cm (5 x 7 inches). It is acid-free for longer lasting documents.

- **HP Everyday Photo Paper**

Print colorful, everyday snapshots at a low cost, using paper designed for casual photo printing. This affordable photo paper dries quickly for easy handling. Get sharp, crisp images when you use this paper with any inkjet printer. It is available in glossy finish in several sizes, including A4, 8.5 x 11 inches, 5 x 7 inches and 4 x 6 inches (10 x 15 cm). It is acid-free for longer lasting documents.

- **Hagaki paper** (for Japan)

Print colorful, everyday snapshots at a low cost, using paper designed for casual photo printing. This affordable photo paper dries quickly for easy handling. Get sharp, crisp images when you use this paper with any inkjet printer.

## Order HP paper supplies

The printer is designed to work well with most types of office paper. Use HP paper for optimum print quality.

To order HP papers and other supplies, go to [www.hp.com](http://www.hp.com). At this time, some portions of the HP website are available in English only.

HP recommends plain papers with the ColorLok logo for printing everyday documents. All papers with the ColorLok logo are independently tested to meet high standards of reliability and print quality, and produce documents with crisp, vivid color, bolder blacks and shorter dry-time than ordinary plain papers. Look for papers with the ColorLok logo in a variety of weights and sizes from major paper manufacturers.

## Tips for selecting and using paper

For the best results, observe the following guidelines.

- Load only one type of paper at a time into the input tray.
- Make sure the paper is loaded correctly.
- Do not overload the input tray.
- To prevent jams, poor print quality, and other printing problems, avoid loading the following paper in the input tray:
  - Multipart forms
  - Media that is damaged, curled, or wrinkled
  - Media with cutouts or perforations



- Media that is heavily textured, embossed, or does not accept ink well
- Media that is too lightweight or stretches easily
- Media that contains staples or clips

## Load paper

When loading paper, ensure that paper is properly loaded in the input tray, adjust the paper-width guides till they touch the edges of the paper, and make sure the printer detects the correct paper size. If the detected paper size or type needs adjustment, change the paper settings in the printer control panel. To turn on the feature to automatically detect paper size, see [Automatic Paper Size Detection](#).

- If the feature to automatically detect paper size is turned off or is not working properly, change the paper size setting from the printer control panel.
- If the feature to automatically detect paper size is turned on, adjust the paper-width guides till they touch the edge of the paper so that the printer can detect the paper width.
- If you are prompted with a message that indicates an unknown paper size, follow instructions on the printer control panel display to adjust the paper-width guides and/or change the paper size.
- If you are loading a custom paper size, adjust the paper-width guides to a width that is closest to the custom width, so the printer can detect the closest width. If necessary, change the paper size from the printer control panel.

### To load standard-size paper

1. Lift the input tray.
2. Slide the paper-width guides out as far as possible.



3. Insert the paper print-side up and slide the paper-width guides till they fit snugly against the sides of the paper.

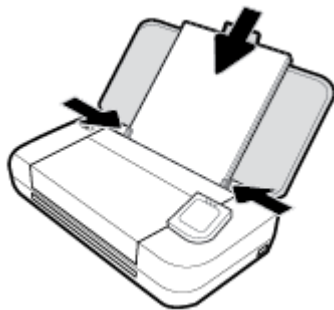

Do not use the paper illustrated in the following graphic.

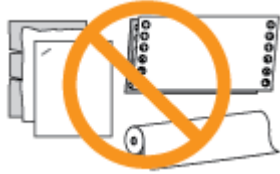

 **NOTE:**

- Do not load paper while the printer is printing.
- After inserting paper, be sure to adjust the paper-width guides so that the printer can detect the paper width.

### To load envelope

1. Lift the input tray.
2. Slide the paper-width guides out as far as possible.



3. Insert the envelope print-side up and the long-edge flap on the left or the short-edge flap at the top.

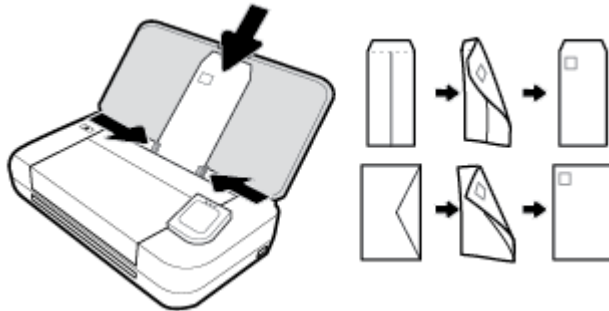

 **NOTE:**

- Do not load envelopes while the printer is printing.
- After inserting paper, be sure to adjust the paper-width guides so that the printer can detect the paper width.

4. Slide the paper-width guides till they fit snugly against the sides of the envelope.

### To load cards and photo paper

1. Lift the input tray.

2. Slide the paper-width guides out as far as possible.

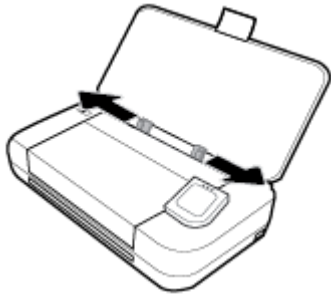

3. Insert the paper print-side up and slide the paper-width guides till they fit snugly against the sides of the paper.

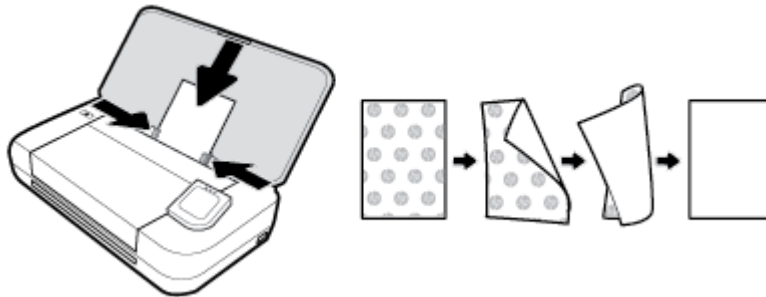
**NOTE:**

- Do not load paper while the printer is printing.
- After inserting paper, be sure to adjust the paper-width guides so that the printer can detect the paper width.

## Load an original in the document feeder

You can copy or scan a document by placing it in the document feeder.

### To load an original in the document feeder

1. Lift the input tray and then open the document feeder tray.
2. Load your original print-side down into the document feeder.
  - a. If you are loading an original printed in portrait orientation, place the pages so that the top edge of the document goes in first. If you are loading an original printed in landscape orientation, place the pages so that the left edge of the document goes in first.
  - b. Slide the paper into the document feeder until you hear a tone or see a message on the printer control panel display indicating that the loaded pages were detected.

**TIP:**

- For more help on loading originals in the document feeder, refer to the the engraved guides on the document feeder.
- If you are loading larger-sized media, pull up the document feeder tray extension.



3. Slide the paper-width guides inward until they stop at the left and right edges of the paper.

## Automatic Paper Size Detection

When this feature is turned on, the printer can automatically detect the width of paper loaded when you adjust the paper-width guides to fit the sides of the paper.

### To turn on or off the feature to automatically detect paper size

1. From the printer control panel, touch or swipe down the tab at the top of the screen to open the Dashboard, touch  (**Setup**).
2. Touch **Preferences**.
3. Scroll down to **Automatic Paper Size Detection** and select **On** or **Off**.

## Update the printer

By default, if the printer is connected to a network and Web Services has been enabled, the printer automatically checks for updates.

### To update the printer using the printer control panel

1. On the printer control panel, touch  (**Home**) to display the Home screen.
2. Select **Setup, Web Services Setup** and then touch **Update the Printer**.

### To update the printer using the embedded web server

1. Open the embeded web server (EWS).  
For more information, see [Embedded web server](#).
2. Click the **Tools** tab.
3. In the **Printer Updates** section, click **Firmware Updates**, and then follow the onscreen instructions.



#### NOTE:

- If a printer update is available, the printer downloads and installs the update, and then restarts.
- If prompted for proxy settings and if your network uses proxy settings, follow the onscreen instructions to set up a proxy server. If you do not have the details, contact your network administrator or the person who set up the network.

## Use the printer battery

Some models of the printer come with a lithium-ion rechargeable battery, which can be installed at the rear of the printer. To see the location, see [Back view](#).



### NOTE:

- The battery is also available for purchase as an optional accessory.
- To purchase, contact your local dealer or HP sales office, or visit [store.hp.com](http://store.hp.com).

## Install or replace the battery

### To install or replace the battery

1. Turn off the printer and disconnect the power.
2. If the printer control panel is lifted, press it down and close the printer top cover. For more information about the printer parts, see [Understand the printer parts](#).
3. Remove the battery cover from the rear of the printer.



4. If you are replacing the battery, remove the original battery by lifting the latch and releasing the battery.

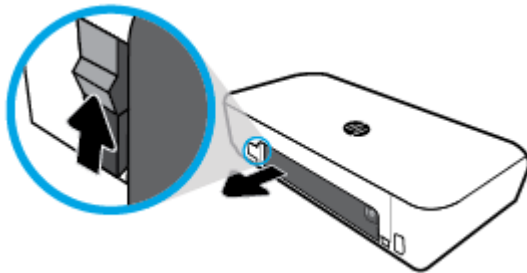

5. Insert the battery into the battery slot.  
The battery status button is on the upper-right corner of the battery.

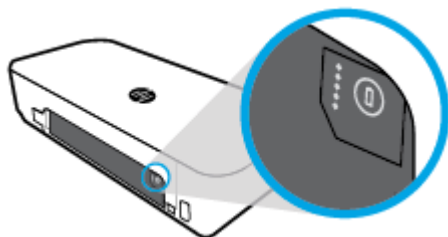

6. Reinsert the battery cover.

To check the battery status, see [Check the battery status](#).



## Check the battery status

### To check battery status from the battery



- ▲ Press the battery status button on the battery.



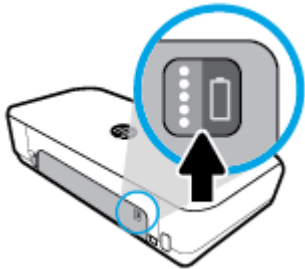

 **TIP:** If the battery is installed in the printer, press similar button on the battery cover.







### To check battery status from the printer control panel

- ▲ Touch  (**Home**) to display the Home screen, and then touch  (**Battery**).

## Battery status

Battery status lights	Number of lights	Color of lights	Battery level
	5	White (Solid)	80%–100%
	4	White (Solid)	60%–79%

Battery status lights	Number of lights	Color of lights	Battery level
	3	White (Solid)	40%-59%
	2	White (Solid)	20%-39%
	1	White (Solid)	11%-19%
	1	White (Blinking)	1%-10% <b>NOTICE:</b> When the battery level reaches a very low level, the printer automatically turns off after 30 seconds.
	Off	Not applicable	The battery cannot be detected or is damaged, corrupted, or cannot be charged for some reason.

## Charge the battery

The battery installed in the printer is charged when the printer is connected to an electrical supply through a power cable.

Charging the battery using AC power can take up to 2.5 hours. If AC power is removed and the printer is turned off, the battery can also be charged when the USB port on the rear of the printer is connected to the charging USB port of another device. The charging USB port must be able to supply a minimum of 1 ampere.

For example:

- USB charging port on a notebook computer (identified by a lightning symbol near the host port)
- USB charger that is connected to a wall outlet (can be generic or one used for mobile phones or tablets)
- USB charger that is connected to the power port in a car (can be generic or one used for mobile phones or tablets)

## Store the battery

### **WARNING!**

- To avoid potential safety issues, use only the battery provided with the printer or the battery purchased as an accessory from HP.
- To purchase, contact your local dealer or HP sales office, or visit [store.hp.com](https://store.hp.com).

 **CAUTION:**

- To prevent damage to a battery, do not expose it to high temperatures for extended periods of time.
  - If the printer is unused and disconnected from external power for more than two weeks, remove the battery and store it separately.
  - To prolong the charge of a stored battery, place it in a cool, dry place.
- 

## Dispose the used battery

---

 **WARNING!** To reduce the risk of fire or burns, do not disassemble, crush, or puncture a battery; short the external contacts on a battery; or dispose of a battery in fire or water. Do not expose a battery to temperatures above 60°C (140°F).

---

## Open the HP printer software (Windows)

After installing the HP printer software, depending on your operating system, do one of the following.

- **Windows 10:** From the computer desktop, click the Start button, click **All apps**, select **HP**, and then select the icon with the printer name.
- **Windows 8.1:** Click the down arrow in lower left corner of the **Start** screen, and then select the icon with the printer name.
- **Windows 8:** On the **Start** screen, right-click an empty area on the screen, click **All Apps** on the app bar, and then select the icon with the printer name.
- **Windows 7, Windows Vista, and Windows XP:** From the computer desktop, click the Start button, select **All Programs**, select **HP**, select the folder for the printer, and then select the icon with the printer name.

## Turn the printer off

Turn the printer off by pressing  (**Power**) located on the printer. Wait until the power light turns off before unplugging the power cord or turning off a power strip. Any other different methods of turning off the printer is not correct.

 **CAUTION:** If you incorrectly turn the printer off, the print carriage might not return to the correct position, causing problems with the cartridges and print quality issues.

---



---

## 3 Print

With this printer, you can print various medias such as documents, brochures, photos and envelopes from either computers, USB flash drives, or mobile devices (smart phones or tablets).

To print documents and photos from mobile devices (such as smart phones or tablets), visit the HP Mobile Printing website at [www.hp.com/go/mobileprinting](http://www.hp.com/go/mobileprinting) . If a local version of this website is not available in your country/region or language, you might be directed to the HP Mobile Printing site in another country/region or language.

---

 **NOTE:** Most print settings are automatically handled by the software application. Change the settings manually only when you want to change print quality, print on specific types of paper, or use special features.

 **TIP:** This printer includes **HP ePrint** , a free service from HP that allows you to print documents on an HP ePrint-enabled printer anytime, from any location, without any additional software or printer drivers. For more information, see [HP ePrint](#) .

---

- [Print documents](#)
- [Print brochures](#)
- [Print on envelopes](#)
- [Print photos](#)
- [Print on special and custom-size paper](#)
- [Print on both sides \(manually\)](#)
- [Print with mobile devices](#)
- [Tips for print success](#)

### Print documents

#### To print documents (Windows)

1. Load paper in the input tray. For more information, see [Load paper](#) .
2. From your software, select **Print** .
3. Make sure your printer is selected.
4. To change settings, click the button that opens the **Preferences** dialog box.

Depending on your software application, this button might be called **Properties** , **Options** , **Printer Setup** , **Printer** , or **Preferences** .

---

 **NOTE:** To set print settings for all print jobs, make the changes in the HP software provided with the printer. For more information on the HP software, see [Printer management tools](#) .

---

5. On the **Printing Shortcut** tab, select a paper type from the **Paper Type** drop-down menu.

To change other print settings, click the other tabs.

For more printing tips, see [Tips for print success](#) .

---

 **NOTE:** If you change the paper size, be sure to load the correct paper in the input tray.

---

6. Click **OK** to confirm the setups. The **Preferences** window closes.
7. Click **Print** or **OK** to begin printing.

### To print documents (OS X)

1. From the **File** menu in your software, choose **Print**.
2. Make sure your printer is selected.
3. Set the print options.

If you do not see options on the Print dialog, click **Show Details**.

- Choose the appropriate paper size in the **Paper Size** pop-up menu.

---

 **NOTE:** If you change the paper size ensure that you have loaded the correct paper.

---

- Select the orientation.
  - Enter the scaling percentage.
4. Click **Print**.

## Print brochures

### To print brochures (Windows)

1. Load paper in the input tray. For more information, see [Load paper](#).
2. From your software, select **Print**.
3. Make sure your printer is selected.
4. To change settings, click the button that opens the **Preferences** dialog box.

Depending on your software application, this button might be called **Properties** , **Options** , **Printer Setup** , **Printer** , or **Preferences** .

---

 **NOTE:** To set print settings for all print jobs, make the changes in the HP software provided with the printer. For more information on the HP software, see [Printer management tools](#).

---

5. On the **Printing Shortcut** tab, select a brochure type from the **Paper Type** drop-down menu.

To change other print settings, click the other tabs.

For more printing tips, see [Tips for print success](#).

---

 **NOTE:** If you change the paper size, be sure to load the correct paper in the input tray.

---

6. Click **OK** to confirm the setups. The **Preferences** window closes.
7. Click **Print** or **OK** to begin printing.

### To print brochures (OS X)

1. From the **File** menu in your software application, choose **Print**.
2. Make sure your printer is selected.

3. Set the print options.

If you do not see options on the Print dialog, click **Show Details**.

- a. Choose the appropriate paper size in the **Paper Size** pop-up menu.



---

**NOTE:** If you change the paper size ensure that you have loaded the correct paper.

---

- b. From the pop-up menu, choose **Paper Type/Quality**, and then choose the option that provides the best quality or maximum dpi.

4. Click **Print**.

## Print on envelopes

Avoid envelopes with the following characteristics:

- Very slick finish
- Self-stick adhesives, clasps, or windows
- Thick, irregular, or curled edges
- Areas that are wrinkled, torn, or otherwise damaged

Make sure the folds of envelopes you load in the printer are sharply creased.



---

**NOTE:** For more information about printing on envelopes, see the documentation available with the software program you are using.

---

### To print envelopes (Windows)

1. Load envelopes in the input tray. For more information, see [Load paper](#).
2. From your software, select **Print**.
3. Make sure your printer is selected.
4. To change settings, click the button that opens the **Preferences** dialog box.

Depending on your software application, this button might be called **Properties**, **Options**, **Printer Setup**, **Printer**, or **Preferences**.



---

**NOTE:** To set print settings for all print jobs, make the changes in the HP software provided with the printer. For more information on the HP software, see [Printer management tools](#).

---

5. On the **Layout** tab, select **Landscape** from the **Orientation** drop-down menu.

On the **Layout** or **Paper/Quality** tab, click **Advanced** button. In the **Paper/Output** area, select an envelope type from the **Paper Size** drop-down menu.

To change other print settings, click the other tabs.

For more printing tips, see [Tips for print success](#).



---

**NOTE:** If you change the paper size, be sure to load the correct paper in the input tray.

---

6. Click **OK** to confirm the setups. The **Properties** window closes.
7. Click **Print** or **OK** to begin printing.

## To print envelopes (OS X)

1. From the **File** menu in your software, choose **Print**.
2. Make sure your printer is selected.
3. Select the appropriate envelope size from the **Paper Size** pop-up menu.

If you do not see options on the Print dialog, click **Show Details**.



---

**NOTE:** If you change the **Paper Size** ensure that you have loaded the correct paper.

---

4. From the pop-up menu, choose **Paper Type/Quality**, and verify the paper type setting is set to **Plain Paper**.
5. Click **Print**.

## Print photos

You can print a photo from either a computer or a USB flash drive.

---

**CAUTION:** Do not remove the USB flash drive from the printer USB port while it is being accessed by the printer. This can damage the files on the drive. When removing the USB flash drive, make sure the USB port light is not blinking.

**NOTE:** The printer does not support encrypted USB flash drives or USB flash drives using the NTFS file system.

---

Do not leave unused photo paper in the input tray. The paper might start to curl, which could impair the quality of your printout. Photo paper should be flat before printing.

**TIP:** You can use this printer to print documents and photos on your mobile device (such as a smartphone or tablet). For more information, visit the HP Mobile Printing website ( [www.hp.com/go/mobileprinting](http://www.hp.com/go/mobileprinting) ). At this time, this website might not be available in all languages.

---

## To print a photo from the computer (Windows)

1. Load paper in the input tray. For more information, see [Load paper](#).
2. From your software, select **Print**.
3. Make sure your printer is selected.
4. To change settings, click the button that opens the **Preferences** dialog box.

Depending on your software application, this button might be called **Properties** , **Options** , **Printer Setup** , **Printer** , or **Preferences** .



---

**NOTE:** To set print settings for all print jobs, make the changes in the HP software provided with the printer. For more information on the HP software, see [Printer management tools](#).

---

5. Select the appropriate options on the **Printing Shortcut** tab.  
To change other print settings, click the other tabs.  
For more printing tips, see [Tips for print success](#).
6. Click **OK** to confirm the setups. The **Preferences** window closes.
7. Click **Print** or **OK** to begin printing.



---

**NOTE:** After the printing is finished, remove unused photo paper from the input tray. Store the photo paper so it does not start to curl, which could reduce the quality of your printout.

---

### To print a photo from the computer (OS X)

1. From the **File** menu in your software, choose **Print**.
2. Make sure your printer is selected.
3. Set the print options.

If you do not see options on the Print dialog, click **Show Details**.

- Choose the appropriate paper size in the **Paper Size** pop-up menu.



---

**NOTE:** If you change the paper size ensure that you have loaded the correct paper.

---

- Select the Orientation.
4. From the pop-up menu, choose **Paper Type/Quality**, and then choose the following settings:
    - **Paper Type:** The appropriate photo paper type
    - **Quality:** Select the option that provides the best quality or maximum dpi.
    - Click the **Color Options** disclosure triangle, and then choose the appropriate **Photo Fix** option.
      - **Off:** applies no changes to the image.
      - **On:** automatically focuses the image; moderately adjusts image sharpness.
  5. Select any other print settings you want, and then click **Print**.

### To print photos from a USB flash drive

You can print a photo from a USB flash drive directly without using a computer.



---

**NOTE:** Only photo files in the format of PNG, JPG, and TIFF can be printed. All the other files cannot be printed.

---

1. Insert a USB flash drive into the USB port on the bottom right side of the printer.
2. Wait for the files and folders on the flash driver to display on the control panel screen.
3. On the control panel display, choose a photo that you want to print and touch **Continue**.
4. Scroll up or down to specify the number of photos to print.
5. Touch **Done** and touch **Continue** to preview the selected photo. If you wish to adjust layout or paper type, touch  (**Setup**), and then touch your selection.
6. Touch **Print** to begin printing.

## Print on special and custom-size paper

If your application supports custom-size paper, set the size in the application before printing the document. If not, set the size in the printer driver. You might need to reformat existing documents to print them correctly on custom-size paper.

### To set up custom sizes (Windows)

1. Depending on your operating system, do one of the following:

- **Windows 10:** From the Windows **Start** menu, click **All apps**, select **Windows System**, and then click **Devices**, select **Devices and printers** under **Related settings** menu. Select the printer name, and select **Print server properties**.
  - **Windows 8.1 and Windows 8:** Point to or tap the upper-right corner of the screen to open the Charms bar, click the **Settings** icon, click or tap **Control Panel**, and then click or tap **View devices and printers**. Click or tap the printer name, and click or tap **Print server properties**.
  - **Windows 7:** From the Windows **Start** menu, click **Devices and Printers**. Select the printer name, and select **Print server properties**.
  - **Windows Vista:** From the Windows **Start** menu, click **Control Panel**, and then click **Printers**. Right-click an empty area in the **Printers** window, and select **Server Properties**.
  - **Windows XP:** From the Windows **Start** menu, click **Control Panel**, and then click **Printers and Faxes**. From the **File** menu, click **Server Properties**.
2. Select the **Create a new form** check box.
  3. Enter the name of the custom size paper.
  4. Enter the dimensions of the custom size in the **Form description (measurements)** section.
  5. Click **Save Form**, and then click **Close**.

### To print on special or custom-size paper (Windows)



**NOTE:** Before you can print on custom-size paper, you must set up the custom size in the Print Server Properties.

1. Load paper in the input tray. For more information, see [Load paper](#).
2. From your software, select **Print**.
3. To print on special or custom-size paper.
4. Click the button that opens the **Preferences** dialog box.

Depending on your software application, this button might be called **Properties**, **Options**, **Printer Setup**, **Printer Properties**, **Printer**, or **Preferences**.



**NOTE:** To set print settings for all print jobs, make the changes in the HP software provided with the printer. For more information on the HP software, see [Printer management tools](#).

5. On the **Layout** tab or **Paper/Quality** tab, click the **Advanced** button.
6. In the **Paper/Output** area, select the custom size from the **Paper Size** drop-down list.



**NOTE:** If you change the paper size, be sure to load the correct paper in the input tray.

7. Select any other print settings that you want, and then click **OK**.
8. Click **Print** or **OK** to begin printing.

### To print on special or custom-size paper (OS X)

Before you can print on custom-size paper, you must set up the custom size in the HP software.

1. Load the appropriate paper in the tray.
2. Create the new custom paper size.

- a. In the software you want to print from, click **File**, and then click **Print**.
  - b. Make sure your printer is selected.
  - c. Click **Manage Custom Sizes** in the **Paper Size** pop-up menu.  
If you do not see options on the Print dialog, click **Show Details**.
  - d. Click **+**, and then select the new item in the list and type a name for the custom paper size.
  - e. Enter the height and width for your custom paper.
  - f. Click **Done** or **OK**, and then click **Save**.
3. Use the created custom paper size to print.
    - a. From the **File** menu in your software application, click **Print**.
    - b. Make sure your printer is selected.
    - c. Choose the custom paper size name you created in the **Paper Size** pop-up menu.
    - d. Select any other print settings you want, and then click **Print**.

## Print on both sides (manually)

### To print on both sides of the page (Windows)

1. Load paper in the input tray. For more information, see [Load paper](#).
2. From your software, select **Print**.
3. Make sure your printer is selected.
4. To change settings, click the button that opens the **Preferences** dialog box.

Depending on your software application, this button might be called **Properties**, **Options**, **Printer Setup**, **Printer**, or **Preferences**.



**NOTE:** To set print settings for all print jobs, make the changes in the HP software provided with the printer. For more information on the HP software, see [Printer management tools](#).

5. On the **Layout** tab, choose either **Flip on Long Edge** or **Flip on Short Edge** from the **Print on Both Sides Manually** drop-down list.

To choose the page size, on the **Layout** or **Paper/Quality** tab, click the **Advanced** button, and then choose a proper size from the **Paper Size** drop-down list.

To change other print settings, click the other tabs.

For more printing tips, see [Tips for print success](#).



**NOTE:** If you change the paper size, be sure to load the correct paper in the input tray and set the paper size on the printer control panel.

6. Click **OK** to confirm the setups. The **Preferences** window closes.
7. Click **Print** or **OK** to begin printing.
8. After one side is printed, follow onscreen instructions to reload the paper back into the input tray.
9. Click **Continue** in the onscreen instructions to print the other side of the paper.

## To print on both sides of the page (OS X)



1. From the **File** menu in your software, choose **Print**.
2. In the Print dialog, choose **Paper Handling** from the pop-up menu and set **Page Order** to **Normal**.
3. Set **Pages to Print** to **Odd Only**.
4. Click **Print**.
5. After all of the odd numbered pages have printed, remove the document from the output tray.
6. Reload the document so that the end that came out of the printer is now going into the printer and the blank side of the document is facing toward the front of the printer.
7. In the Print dialog, return to the **Paper Handling** pop-up menu and set the page order to **Normal** and the pages to print to **Even Only**.
8. Click **Print**.

# Print with mobile devices

## Print from mobile devices

You can print documents and photos directly from your mobile devices, including iOS, Android, Windows Mobile, Chromebook and Amazon Kindle.

### To print from mobile devices

1. Make sure your printer is connected to the same network as your mobile device.
2. Enable printing on your mobile device:
  - **iOS:** Use the **Print** option from the **Share** menu. No setup is required since iOS AirPrint is preinstalled.  
 **NOTE:** Devices running iOS 4.2 or later have AirPrint preinstalled.
  - **Android:** Download the HP Print Service Plugin (supported by most Android devices) from the Google Play Store and enable it on your device.  
 **NOTE:** Devices running Android 4.4 or later are supported by the HP Print Service Plugin. Devices running Android 4.3 or earlier can print using the HP ePrint app, available in the Google Play Store.
  - **Windows Mobile:** Tap **Print** from the **Device** menu. No setup is required since the software is preinstalled.  
 **NOTE:** If your printer is not listed, you might need to do a one-time setup of the printer using the **Add Printer** wizard.
  - **Chromebook:** Download and install the **HP Print for Chrome** app from the Chrome Web Store to enable both Wi-Fi and USB printing.
  - **Amazon Kindle Fire HD9 and HDX:** The first time you select **Print** on your device, the HP Print Service Plugin is automatically downloaded to enable mobile printing.



---

 **NOTE:** For detailed information about enabling printing from your mobile devices, visit [www.hp.com/go/mobileprinting](http://www.hp.com/go/mobileprinting). If a local version of this website is not available in your country/region or language, you might be directed to the HP Mobile Printing website in another country/region or language.

---

3. Make sure the loaded paper matches the paper settings of the printer (see [Load paper](#) for more information). Accurately setting the paper size for the paper that is loaded enables your mobile device to know what paper size it is printing.

## Access printer features and troubleshooting information from mobile devices

The HP All-in-One Printer Remote app helps you set up and use your HP printer for printing, scanning, storing, and sharing documents from virtually anywhere. It can also report printer status, perform maintenance tasks, order original HP printing supplies, identify and resolve printer errors, and provide troubleshooting assistance and support from HP.

HP All-in-One Printer Remote is supported on iOS, Android and Windows Mobile. Install it from the App Store or Google Play Store to enhance the capabilities of your printer.

 **NOTE:** Some features might not be available with all printer models. Also, at this time, HP All-in-One Printer Remote might not be available in all languages. For more information, visit [www.hp.com/support](http://www.hp.com/support).

---

## Tips for print success

Software settings selected in the print driver only apply to printing, they do not apply to copying or scanning.

You can print your document on both sides of the paper. For more information, see [Print on both sides \(manually\)](#).

### Ink tips

- If the print quality is not acceptable, see [Printing issues](#) for more information.
- Use Original HP cartridges.

Original HP cartridges are designed and tested with HP printers and papers to help you easily produce great results, time after time.

 **NOTE:** HP cannot guarantee the quality or reliability of non-HP supplies. Product service or repairs required as a result of using a non-HP supply will not be covered under warranty.

If you believe you purchased Original HP cartridges, go to [www.hp.com/go/anticounterfeit](http://www.hp.com/go/anticounterfeit).

---

- Install both the black and color cartridges correctly.  
For more information, see [Replace the cartridges](#).
- Check the estimated ink levels in the cartridges to make sure there is sufficient ink.  
Ink level warnings and indicators provide estimates for planning purposes only.  
For more information, see [Check the estimated ink levels](#).
- Always turn off the printer with  (**Power**) to allow the printer to protect the nozzles.

## Paper loading tips

For more information, also see [Load paper](#).

- Ensure the paper is properly loaded in the input tray and then adjust the paper-width guides. Change the paper settings if the paper size is not correctly detected.
- Load a stack of paper (not just one page). All the paper in the stack should be of the same size and type to avoid a paper jam.
- Load paper with the print-side up.
- Ensure that paper loaded in the input tray lays flat and the edges are not bent or torn.
- Adjust the paper-width guides in the input tray to fit snugly against all paper. Make sure the guides do not bend the paper in the tray.

## Printer settings tips (Windows)

- To change default print settings, click **Print & Scan**, and then click **Set Preferences** in the HP printer software.

Open the HP printer software. For more information, see [Open the HP printer software \(Windows\)](#).

- To select the number of pages to print per sheet, on the **Layout** tab of the printer driver, select the appropriate option from the **Pages per Sheet** drop-down list.
- If you want to change the page orientation, set it in your application interface.
- To view more printing settings, on the **Layout** or **Paper/Quality** tab of the printer driver, click the **Advanced** button to open the **Advanced Options** dialog box.



---

**NOTE:** The preview on the **Layout** tab cannot reflect what you select from the **Pages per Sheet Layout**, the **Booklet**, or the **Page Borders** drop-down lists.

---

- **Print in Grayscale:** Allows you to print a black and white document using the black ink only. Select **Black Ink Only**, and then click the **OK** button.
- **Pages per Sheet Layout:** Helps you specify the order of the pages if you print document in more than two pages per sheet.
- **Borderless Printing:** Select this feature to print photos without border. Not all paper types support this feature. You will see an alert icon beside the option if the selected paper type in the **Media** drop-down list does not support it.
- **HP Real Life Technologies:** This feature smooths and sharpens images and graphics for improved print quality.
- **Booklet:** Allows you to print a multiple-page document as a booklet. It places two pages on each side of a sheet that can then be folded into a booklet in half size of the paper. Select a binding method from the drop-down list, and then click **OK**.

- **Booklet-LeftBinding:** The binding side after folded into a booklet appears at the left side. Select the option if your reading habit is from left to right.
- **Booklet-RightBinding:** The binding side after folded into a booklet appears at the right side. Select the option if your reading habit is from right to left.
- **Page Borders:** Allows you to add the borders to the pages if you print the document with two or more pages per sheet.
- You can use printing shortcut to save time setting printing preferences. A printing shortcut stores the setting values that are appropriate for a particular kind of job, so that you can set all the options with a single click.

To use it, go to the **Printing Shortcuts** tab, select a printing shortcut, and then click **OK**.

To add a new printing shortcut, after making settings, click **Save As** and enter a name, and then click **OK**.

To delete a printing shortcut, select it, and then click **Delete**.



**NOTE:** You cannot delete the default printing shortcuts.

### Printer settings tips (OS X)

- On the Print dialog, use the **Paper Size** pop-up menu to select the size of paper loaded in the printer.
- On the Print dialog, choose the **Paper Type/Quality** pop-up menu and select the appropriate paper type and quality.

---

# 4 Copy and scan

You can produce high-quality color and black-and-white copies on a variety of paper types and sizes.

---

 **NOTE:** For better copy quality, use color copy and avoid copying under direct sunlight or intense light.

---

- [Copy](#)
- [Scan](#)
- [Tips for copy and scan success](#)

## Copy

### To copy documents

1. Make sure you have paper loaded in the input tray. For more information, see [Load paper](#).
2. Place your original print-side down in the document feeder. For more information, see [Load an original in the document feeder](#).
3. From the printer control panel display, touch **Copy**.
4. Select **Document**.
5. Scroll left or right to select the number of copies.

---

 **TIP:** To save these settings as defaults for future jobs, from the printer control panel display, touch **Copy**, touch  (**Setup**), and then touch **Save Current Settings**.

---

6. Touch **Start Black** or **Start Color** to start the copy job.

### Copy settings

You can customize copy jobs using the various settings available from the printer control panel.

In the **Copy** menu, touch  (**Setup**) and change the desired settings.

- Resize
- Paper Size and Type
- Quality
- Lighter/Darker
- Enhancements
- Binding Margin
- Save Current Settings
- Restore Factory Defaults

# Scan

You can scan documents, photos and other paper types, and send them to a variety of destinations, such as a computer or an email recipient.

When scanning documents with the HP printer software, you can scan to a format that can be searched and edited.

---

 **NOTE:** Some scan functions are only available after you have installed the HP printer software.

 **TIP:** If you have problems scanning documents, see [Scan issues](#).

---

- [Scan to a computer](#)
- [Scan to a USB](#)
- [Scan to email](#)
- [Scanning documents as editable text](#)
- [Create a new scan shortcut \(Windows\)](#)
- [Change scan settings \(Windows\)](#)

## Scan to a computer

Before scanning to a computer, make sure you have already installed the HP recommended printer software. The printer and computer must be connected and turned on.

In addition, on Windows computers, the printer software must be running prior to scanning.

You can use the HP printer software to scan documents into editable text. For more information, see [Scanning documents as editable text](#).

### To scan an original from the printer control panel

1. Load your original print-side down in the document feeder.  
For more information, see [Load an original in the document feeder](#).
2. Touch **Scan**, and then select **Computer**.
3. Touch a computer that you want to scan to.
4. Select the desired scan type.
  - **Save as PDF**
  - **Save as JPEG**
  - **Save as Editable Text (OCR)**
  - **Email as PDF**
  - **Email as JPEG**
  - **Everyday Scan**
5. Touch **Start Scan**.

### To enable the scan to a computer feature (Windows)

If the printer is connected to the computer with a USB connection, the feature for scanning to computer is enabled by default and cannot be disabled.

If you are using network connection, follow these instructions if the feature has been disabled, and you wish to enable it again.

1. Open the HP printer software. For more information, see [Open the HP printer software \(Windows\)](#).
2. Go to the **Scan** section.
3. Select **Manage Scan to Computer**.
4. Click **Enable**.

### To enable the scan to a computer feature (OS X)

The scan to a computer feature is enabled by default from the factory. Follow these instructions if the feature has been disabled, and you wish to enable it again.

1. Open HP Utility.



---

**NOTE:** HP Utility is located in the **HP** folder in the **Applications** folder.

---

2. Under **Scan Settings**, click **Scan to Computer**.
3. Ensure that **Enable Scan to Computer** is selected.

### To scan an original from HP printer software (Windows)

1. Load your original print-side down in the document feeder.  
For more information, see [Load an original in the document feeder](#).
2. Open the HP printer software. For more information, see [Open the HP printer software \(Windows\)](#).
3. Go to the **Scan** section, click **Scan a Document or Photo**
4. Select the desired scan type.
  - **Save as PDF**
  - **Save as JPEG**
  - **Save as Editable Text (OCR)**
  - **Email as PDF**
  - **Email as JPEG**
  - **Everyday Scan**



---

**NOTE:**

- The initial screen allows you to review and modify basic settings. Click the **More** link at the top right corner of the Scan dialog to review and modify detailed settings.
  - For more information, see [Change scan settings \(Windows\)](#).
  - If **Show Viewer After Scan** is selected, you can make adjustments to the scanned image in the preview screen.
- 
5. Click **Scan**.
  6. Select **Save** if you want to keep the application open for another scan, or select **Done** to exit the application.

After the scan is saved, Windows Explorer will open the directory where the scan was saved.

## To scan an original from HP printer software (OS X)

1. Open HP Easy Scan.  
HP Easy Scan is located in the **Applications** folder.
2. Choose the type of scan profile you want.
3. Click **Scan**.

## Scan to a USB

You can scan directly to a USB flash drive from the printer control panel without using a computer or the HP printer software provided with the printer.

 **CAUTION:** Do not remove the flash drive from the printer USB port while it is being accessed by the printer. This can damage the files on the USB flash drive. You can safely remove a USB flash drive only when the USB port light is not blinking.

 **NOTE:**

- The printer does not support encrypted USB flash drives.
- You can also use the HP printer software to scan documents into editable text. For more information, see [Scanning documents as editable text](#).

## To scan an original to a USB from the printer control panel

1. Load your original print-side down in the document feeder.
2. Insert a USB flash drive.
3. Touch **Scan**, and then select **USB**.
4. Make changes to scan options, if needed.
5. Touch **Start Scan**.

## Scan to email

The Scan-to-Email App is an application that allows you to quickly scan and email photos or documents to the specified recipients directly from your HP All-in-One printer. You can set up your email addresses, log in to your accounts with the given PIN codes, and then scan and email your documents.

This section contains the following topics:

- [Set up Scan to Email](#)
- [Scan a document or photo to email](#)
- [Change account settings](#)

## Set up Scan to Email

### To set up Scan to Email

1. Enable Web Services on the printer. For more information, see [Set up Web Services](#).
2. From Home screen, touch **Apps**, and then touch **Scan-to-Email** app.
3. On the **Welcome** screen, touch **Continue**.
4. Touch in the **Email** box to enter your email address, and then touch **Done**.

5. Touch **Continue**.
6. A PIN will be sent to the email address you entered. Touch **Continue**.
7. Touch the **PIN** to enter your PIN and then touch **Done**.
8. Touch **Store Email** or **Auto-login**, depending upon how you want the printer to store your login information.
9. Select your scan type by touching **Photo** or **Document**.
10. For photos, select the scan settings, and touch **Continue**.  
For documents, continue with the next step.
11. Verify the email information, and touch **Continue**.
12. Touch **Scan to Email**.
13. Touch **OK** when the scan completes, and then touch **Yes** to send another email, or **No** to finish.

## Scan a document or photo to email

### To scan a document or photo to email from the control panel

1. Load your original print-side down in the document feeder.
2. From Home screen, touch **Apps**, and then touch **Scan-to-Email** app.
3. On the control panel display, select the account that you want to use, and touch **Continue**.



**NOTE:** Select **My account is not listed** if you do not have an account. You will be prompted to enter your email address and receive a PIN.

4. If prompted, enter the PIN.
5. Select your scan type by touching **Photo** or **Document**.
6. For photos, select the scan settings, and touch **Continue**.  
For documents, continue with the next step.
7. To add or remove recipients, touch **Modify Recipient(s)**, and when finished touch **Done**.
8. Verify the email information and touch **Continue**.
9. Touch **Scan to Email**.
10. Touch **OK** when the scan completes, and then touch **Yes** to send another email, or **No** to finish.

### To scan a document or photo to email from HP printer software (Windows)

1. Load your original print-side down in the document feeder.
2. Open the HP printer software. For more information, see [Open the HP printer software \(Windows\)](#).
3. In the printer software, click **Scan a Document or Photo**.
4. Select the type of scan you want and then click **Scan**.  
Choose **Email as PDF** or **Email as JPEG** to open your email software with the scanned file as an attachment.



**NOTE:**

- The initial screen allows you to review and modify basic settings. Click the **More** link at the top right corner of the Scan dialog to review and modify detailed settings.
- For more information, see [Change scan settings \(Windows\)](#).

## Change account settings

### To change account settings from the printer control panel

1. From Home screen, touch **Apps**, and then touch **Scan-to-Email** app.
2. Select the account that you want to change, and touch **Modify**.
3. Select which setting you want to modify, and follow the onscreen prompts.
  - Auto-login
  - Store Email
  - Remove from list
  - Change PIN
  - Delete Account

## Scanning documents as editable text

When scanning documents, you can use the HP software to scan documents into a format that you can search, copy, paste, and edit. This allows you to edit letters, newspaper clippings, and many other documents.

- [Scan documents as editable text](#)
- [Guidelines for scanning documents as editable text](#)

## Scan documents as editable text

Use the following guidelines for scanning documents as editable text.

### To scan a document to editable text (Windows)

You can scan different types of printed documents into a format in which you can search and edit.

If **Save as Editable Text (OCR)** is not in the list of available scan options, you need to reinstall your software and choose that option.

1. Load your original print-side down in the document feeder.
2. Open the HP printer software. For more information, see [Open the HP printer software \(Windows\)](#).
3. In the printer software, click **Scan a Document or Photo**.
4. Select **Save as Editable Text (OCR)** and click **Scan**.

**NOTE:**

- The initial screen allows you to review and modify basic settings. Click the **More** link at the top right corner of the Scan dialog to review and modify detailed settings.
- For more information, see [Change scan settings \(Windows\)](#).
- If **Show Viewer After Scan** is selected, you can make adjustments to the scanned image in the preview screen.

## To scan documents as editable text (OS X)

1. Load your original print-side down in the document feeder.
2. Open HP Easy Scan.  
HP Easy Scan is located in the **Applications** folder.
3. Click the **Scan** button.  
A dialog appears requesting confirmation of your scanning device and the scan settings preset.
4. Follow the onscreen instructions to complete the scan.
5. When all of the pages have been scanned, select **Save** from the **File** menu.
6. Select the type of editable text you want from the **Format** pop-up menu.
7. Click **Save**.

## Guidelines for scanning documents as editable text

Use the following guidelines to ensure the software successfully converts your documents.

- **Make sure the document feeder window is clean.**  
Smudges or dust on the scan glass or document feeder window can prevent the software from converting the document to editable text.
- **Make sure the document is loaded correctly.**  
Make sure the original is properly loaded and that the document is not skewed.
- **Make sure the text on the document is clear.**  
To successfully convert the document to editable text, the original must be clear and of high quality. The following conditions can cause the software to not convert the document successfully:
  - The text on the original is faint or wrinkled.
  - The text is too small.
  - The structure of the document is too complex.
  - The text is tightly spaced. For example, if the text that the software converts has missing or combined characters, "rn" might appear as "m."
  - The text is on a colored background. Colored backgrounds can cause images in the foreground to blend too much.
- **Choose the correct profile.**  
Be sure to select a shortcut or preset that allows scanning as editable text. These options use scan settings designed to maximize the quality of your OCR scan.  
**Windows:** Use the **Editable Text (OCR)** or **Save as PDF** shortcuts.  
**OS X:** Use the **Documents with Text** preset.
- **Save your file in the correct format.**  
If you want to extract just the text from the document, without any of the formatting of the original, select a plain text format, such as **Text (.txt)** or **TXT**.

If you want to extract the text, as well as some of the formatting of the original, select Rich Text Format, such as **Rich Text (.rtf)** or **RTF**, or searchable PDF format, such as **Searchable PDF (.pdf)** or **Searchable PDF**.

## Create a new scan shortcut (Windows)

You can create your own scan shortcut to make scanning easier. For example, you might want to regularly scan and save photos in PNG format, rather than JPEG.

1. Load your original print-side down in the document feeder.
2. Open the HP printer software. For more information, see [Open the HP printer software \(Windows\)](#).
3. In the printer software, click **Scan a Document or Photo**.
4. Click **Create New Scan Shortcut**.
5. Enter a descriptive name, choose an existing shortcut on which to base your new shortcut, and then click **Create**.

For example, if you are creating a new shortcut for photos, choose either **Save as JPEG** or **Email as JPEG**. This makes available the options for working with graphics when scanning.

6. Change the settings for your new shortcut to meet your needs, and then click the save icon to the right of the shortcut.



### NOTE:

- The initial screen allows you to review and modify basic settings. Click the **More** link at the top right corner of the Scan dialog to review and modify detailed settings.
- For more information, see [Change scan settings \(Windows\)](#).

## Change scan settings (Windows)

You can modify any of the scan settings either for a singular use or save the changes to use permanently. These settings include options such as page size and orientation, scan resolution, contrast, and the folder location for saved scans.

1. Load your original print-side down in the document feeder.
2. Open the HP printer software. For more information, see [Open the HP printer software \(Windows\)](#).
3. In the printer software, click **Scan a Document or Photo**.
4. Click the **More** link in the top right corner of the HP Scan dialog.

The detailed settings pane appears on the right. The left column summarizes the current settings for each section. The right column allows you to change the settings in the highlighted section.

5. Click each section at the left of the detailed settings pane to review the settings in that section.

You can review and change most settings using drop-down menus.

Some settings allow greater flexibility by displaying a new pane. These are indicated by a + (plus sign) at the right of the setting. You must either accept or cancel any changes on this pane to return to the detailed settings pane.

6. When you have finished changing settings, do one of the following.

- Click **Scan**. You are prompted to save or reject the changes to the shortcut after the scan is finished.
- Click the save icon to the right of the shortcut. It saves the changes into the shortcut so that you can reuse them next time. Otherwise, the changes only affect the current scan. Then click **Scan**.

[Go online to learn more about using the HP Scan software.](#) Learn how to:

- Customize scan settings, such as image file type, scan resolution, and contrast levels.
- Scan to network folders and cloud drives.
- Preview and adjust images before scanning.

## Tips for copy and scan success

Use the following tips to copy and scan successfully.

- To make a large copy of a small original, scan the original into the computer, resize the image in the scanning software, and then print a copy of the enlarged image.
- If you want to adjust scan size, output type, scan resolution, or file type, and so on, start scan from the printer software.
- To avoid incorrect or missing scanned text, make sure the brightness is set appropriately in the software.
- If you want to scan a document with several pages into one file instead of multiple files, start the scan with the printer software instead of selecting **Scan** from the printer display.
- For optimal quality, avoid copying or scanning under direct sunlight or intense lighting.

# 5 Web services

The printer offers innovative, web-enabled solutions that can help you quickly access the Internet, obtain documents, and print them faster and with less hassle—and all without using a computer.

 **NOTE:** To use these web features, the printer must be connected to the Internet. You cannot use these web features if the printer is connected using a USB cable.

This section contains the following topics:

- [What are Web Services?](#)
- [Set up Web Services](#)
- [Use Web Services](#)
- [Remove Web Services](#)

## What are Web Services?

### HP ePrint

- **HP ePrint** is a free service from HP that allows you to print to your HP ePrint-enabled printer anytime, from any location. It's as simple as sending an email to the email address assigned to your printer when you enable Web Services on the printer. No special drivers or software are needed. If you can send an email, you can print from anywhere, using **HP ePrint**.

 **NOTE:** You can sign up for an account on [HP Connected \(www.hpconnected.com\)](http://www.hpconnected.com). This site might not be available in all countries/regions, and sign in to configure the ePrint settings.

Once you have signed up for an account on [HP Connected \(www.hpconnected.com\)](http://www.hpconnected.com). This site might not be available in all countries/regions, you can sign in to view your **HP ePrint** job status, manage your **HP ePrint** printer queue, control who can use your printer's **HP ePrint** email address to print, and get help for **HP ePrint**.

### Print apps

- With print apps, you can scan and store your documents digitally on the Web, and also access and share the content, and do more.

## Set up Web Services

Before you set up Web Services, make sure your printer is connected to the Internet.

To set up Web Services, use one of the following methods.

### To set up Web Services using the printer control panel

1. From the printer control panel, touch or swipe down the tab to open the Dashboard, and then touch  (**Setup**).
2. Touch **Web Services Setup**.
3. Touch **Accept** to accept the Web Services terms of use and enable Web Services.

4. On the screen that appears, touch **OK** to allow the printer to automatically check for product updates.



**NOTE:** If prompted for proxy settings and if your network uses proxy settings, follow the onscreen instructions to set up a proxy server. If you do not have the proxy details, contact your network administrator or the person who set up the network.

5. If the **Printer Update Options** screen is displayed, select one of the options.
6. When the printer is connected to the server, the printer prints an information page. Follow the instructions on the information page to finish the setup.

#### To set up Web Services using the embedded web server

1. Open the EWS. For more information, see [Open the embedded web server](#).
2. Click the **Web Services** tab.
3. In the **Web Services Settings** section, click **Setup**, click **Continue**, and follow the onscreen instructions to accept the terms of use.
4. If prompted, choose to allow the printer to check for and install printer updates.



**NOTE:**

- When updates are available, they are automatically downloaded and installed, and then the printer restarts.
  - If prompted for proxy settings and if your network uses proxy settings, follow the onscreen instructions to set up a proxy server. If you do not have the proxy details, contact your network administrator or the person who set up the network.
5. When the printer is connected to the server, the printer prints an information page. Follow the instructions on the information page to finish the setup.

#### To set up Web Services using the HP printer software (Windows)

1. Open the HP printer software. For more information, see [Open the HP printer software \(Windows\)](#).
2. In the window that appears, double-click **Print & Scan** and then select **Connect Printer to the Web** under Print. The printer's home page (embedded web server) opens.
3. Click the **Web Services** tab.
4. In the **Web Services Settings** section, click **Setup**, click **Continue**, and follow the onscreen instructions to accept the terms of use.
5. If prompted, choose to allow the printer to check for and install printer updates.



**NOTE:**

- When updates are available, they are automatically downloaded and installed, and then the printer restarts.
  - If prompted for proxy settings and if your network uses proxy settings, follow the onscreen instructions to set up a proxy server. If you do not have the proxy details, contact your network administrator or the person who set up the network.
6. When the printer is connected to the server, the printer prints an information page. Follow the instructions on the information page to finish the setup.

## Use Web Services

The following section describes how to use and configure Web Services.

- [HP ePrint](#)
- [Print apps](#)

### HP ePrint

To use **HP ePrint**, do the following:

- Be sure you have an Internet- and email-capable computer or mobile device.
- Enable Web Services on the printer. For more information, see [Set up Web Services](#).

---

 **TIP:** For more information about managing and configuring **HP ePrint** settings and to learn about the latest features, visit [HP Connected](#). This site might not be available in all countries/regions.

---

#### To print documents using HP ePrint

1. On your computer or mobile device, open your email application.
2. Create a new email message, and then attach the file that you want to print.
3. Enter the **HP ePrint** email address in the “To” field, and then select the option to send the email message.

---



 **NOTE:** Do not enter any additional email addresses in either the “To” or “Cc” fields. The **HP ePrint** server does not accept print jobs if there are multiple email addresses.

---

#### To customize the HP ePrint email address

1. From the printer control panel, touch or swipe down the tab at the top of the screen to open the Dashboard, and then touch  (**HP ePrint**).
2. Touch **Print Info**. The printer prints an information page that contains the printer code and instructions on how to customize the email address.

#### To turn off HP ePrint

1. From the printer control panel, touch or swipe down the tab at the top of the screen to open the Dashboard, touch  (**HP ePrint**), and then touch  (**Web Services Settings**).
2. Touch **HP ePrint**, and then touch **Off**.

---

 **NOTE:** To remove all Web Services, see [Remove Web Services](#).

---

### Print apps

With print apps, you can scan and store your documents digitally on the Web, and also access and share the content, and do more.

#### To use print apps

1. From the Home screen, then touch **Apps**.
2. Touch the print app you want to use.



**TIP:**

- To learn more about individual print apps and to add, configure, or remove print apps, visit HP Connected ([www.hpconnected.com](http://www.hpconnected.com)). This site might not be available in all countries/regions.
- You can also turn off print apps from EWS. To do so, open EWS (see [Embedded web server](#)), click the **Web Services** tab and turn off the setting; or click the **Settings** tab, and select the desired option on the **Administrator Settings** page.

## Remove Web Services

Use the following instructions to remove Web Services.

### To remove Web Services using the printer control panel

1. From the top of the screen, touch or swipe down the tab to open the Dashboard, touch  (**HP ePrint**), and then touch  (**Web Services Settings**).
2. Touch **Remove Web Services**.

### To remove Web Services using the embedded web server

1. Open the EWS. For more information, see [Open the embedded web server](#).
2. Click the **Web Services** tab, and then click **Remove Web Services** in the **Web Services Settings** section.
3. Click **Remove Web Services**.
4. Click **Yes** to remove Web Services from your printer.



---

## 6 Work with cartridges

To ensure the best print quality from the printer, you need to perform some simple maintenance procedures.

 **TIP:** If you have problems copying documents, see [Printing issues](#).

This section contains the following topics:

- [Information about Cartridges](#)
- [Check the estimated ink levels](#)
- [Printing with black or color ink only](#)
- [Replace the cartridges](#)
- [Order the cartridges](#)
- [Store printing supplies](#)
- [Cartridge warranty information](#)

### Information about Cartridges

The following tips help maintain HP cartridges and ensure consistent print quality.

- The instructions in this guide are for replacing cartridges, and are not intended for first time installation. For the first time installation, follow the instructions in the setup poster provided with the printer.
- Keep all cartridges in the original sealed packages until they are needed.
- Be sure to turn off the printer properly. For more information, see [Turn the printer off](#).
- Do not clean the cartridge unnecessarily. This wastes ink and shortens the life of the cartridges.
- Handle cartridges carefully. Dropping, jarring, or rough handling during installation can cause temporary printing problems.
- If you are transporting the printer, do the following to prevent ink leaking from the printer or other damage from occurring to the printer:
  - Make sure you turn off the printer by pressing  (**Power**). Wait until all sounds of internal motion stop before unplugging the printer.
  - Make sure you leave the cartridges installed.
  - The printer must be transported sitting flat; it should not be placed on its side, back, front, or top.

### Check the estimated ink levels

You can check the estimated ink levels from the printer software or from the printer control panel.

### To check the estimated ink levels from the printer control panel

1. From the printer control panel, touch or swipe down the tab at the top of the screen to open the Dashboard.
2. Touch  (**Ink**) to check the estimated ink levels.

### To check the estimated ink levels from the HP printer software (Windows)

1. Open the HP printer software. For more information, see [Open the HP printer software \(Windows\)](#).
2. In the printer software, from the main menu on the top, click **Estimated Cartridge Levels**.

### To check the ink levels from the HP printer software (OS X)

1. Open HP Utility.  
HP Utility is located in the **HP** folder in the **Applications** folder at the top level of the hard disk.
2. Select the printer from the **Devices** list.
3. Click **Supplies Status**.  
The estimated ink levels appear.



#### NOTE:

- If you have installed a refilled or remanufactured cartridge, or a cartridge that has been used in another printer, the ink level indicator might be inaccurate or unavailable.
- Ink from the cartridges is used in the printing process in a number of different ways, including in the initialization process, which prepares the printer and cartridges for printing, and in printhead servicing, which keeps print nozzles clear and ink flowing smoothly. In addition, some residual ink is left in the cartridge after it is used. For more information, see [www.hp.com/go/inkusage](http://www.hp.com/go/inkusage).

## Printing with black or color ink only

For regular usage, this product is not designed to print using only one cartridge. However, when one cartridge runs out of ink, you can remove it and use the other cartridge to continue printing.

The printer supports this capability only if the cartridge has sufficient ink. Therefore, you should replace the empty cartridge as soon as possible.

## Replace the cartridges

If you do not already have spare cartridges, see [Order the cartridges](#). Not all cartridges are available in all countries/regions.



**CAUTION:** HP recommends that you install any missing cartridges as soon as possible to avoid print quality issues and possible extra ink usage or damage to the ink system.

For information on recycling used ink supplies, see [HP inkjet supplies recycling program](#).

### To replace the cartridges

1. Make sure the printer is turned on.

2. Open the cartridge access door and wait for the print carriage to stop moving, which should take a few seconds.

---

**CAUTION:** Do not replace or install cartridges when the print carriage is still moving.

---

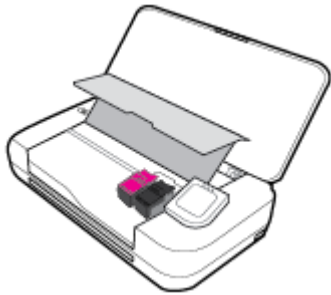

3. Open the cartridge latch as shown and gently remove the cartridge from its slot.

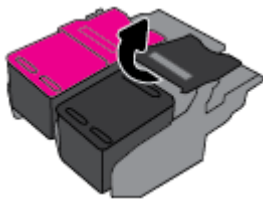

4. Remove the protective film from a new cartridge.

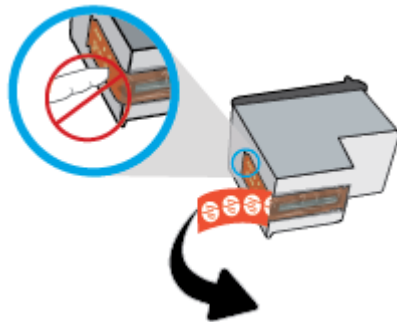

5. Insert the new cartridge into its slot at the same angle at which you removed the old cartridge, and then close the latch as illustrated. Press the latch to make sure it is seated flat on the cartridge.

---

**NOTE:** Install the color cartridge on the left and the black cartridge on the right.

---

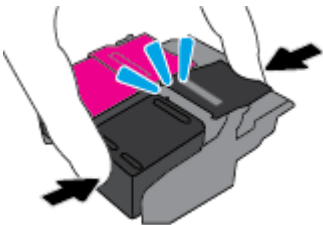

6. Repeat steps 3 through 5 for the other cartridge if needed.
7. Close the cartridge access door.
8. Wait for the carriage to complete the cartridge initialization routine before using the printer.

---

**NOTE:** Do not open the cartridge access door until the cartridge initialization is complete

---

## Order the cartridges

To order cartridges, go to [www.hp.com](http://www.hp.com) . At this time, some portions of the HP website are available in English only. Ordering cartridges online is not supported in all countries/regions. However, many countries have information on ordering by telephone, locating a local store and printing a shopping list. In addition, you can visit the [www.hp.com/buy/supplies](http://www.hp.com/buy/supplies) page to obtain information about purchasing HP products in your country.

Use only the replacement cartridges that have the same cartridge number as the cartridge you are replacing. You can find the cartridge number in the following places:

- On the label of the cartridge you are replacing.
- On a sticker inside the printer. Open the cartridge access door to locate the sticker.
- In the printer software, click **Shop**, and then click **Shop For Supplies Online**.
- In the embedded web server, by clicking the **Tools** tab, and then, under **Product Information** clicking **Ink Gauge**. For more information, see [Embedded web server](#).

## Store printing supplies

- Keep all cartridges in the original sealed packages until they are needed.
- Cartridges can be left in the printer for extended periods of time. However, to assure optimal cartridge health, be sure to turn off the printer properly when the printer is not in use. For more information, see [Turn the printer off](#) .
- Store cartridges at room temperature (15-35° C or 59-95° F).

## Cartridge warranty information

The HP cartridge warranty is applicable when the product is used in its designated HP printing device. This warranty does not cover HP ink products that have been refilled, remanufactured, refurbished, misused, or tampered with.

During the warranty period the product is covered as long as the HP ink is not depleted and the end of warranty date has not been reached. The end of warranty date, in YYYY/MM format, may be found on the ink product.



---

# 7 Network setup

Additional advanced settings are available from the printer's home page (embedded web server or EWS). For more information, see [Open the embedded web server](#).

This section contains the following topics:

- [Set up the printer for wireless communication](#)
- [Change network settings](#)
- [Use Wi-Fi Direct](#)
- [Easily connect and print with Bluetooth® Smart](#)

## Set up the printer for wireless communication

- [Before you begin](#)
- [Set up the printer on your wireless network](#)
- [Change the connection type](#)
- [Test the wireless connection](#)
- [Turn on or off the wireless capability of the printer](#)

---

 **NOTE:** If you encounter problems connecting the printer, see [Network and connection issues](#).

 **TIP:** For more information about setting up and using the printer wirelessly, visit the HP Wireless Printing Center ( [www.hp.com/go/wirelessprinting](http://www.hp.com/go/wirelessprinting) ).

---

### Before you begin

Ensure the following:

- The wireless network is set up and working properly.
- The printer and the computers that use the printer are on the same network (subnet).

While connecting the printer, you might be prompted to enter the wireless network name (SSID) and a wireless password.

- The wireless network name is the name of your wireless network.
- The wireless password prevents other people from connecting to your wireless network without your permission. Depending on the level of security required, your wireless network might use either a WPA passphrase or WEP key.

If you have not changed the network name or the security passkey since setting up your wireless network, you can sometimes find them on the back or side of the wireless router.

If you cannot find the network name or the security password or cannot remember this information, see the documentation provided with your computer or with the wireless router. If you still cannot find this information, contact your network administrator or the person who set up the wireless network.

## Set up the printer on your wireless network

Use the Wireless Setup Wizard from the printer control panel display to set up wireless communication.



**NOTE:** Before you proceed, go through the list at [Before you begin](#).

1. From the printer control panel, touch or swipe down the tab at the top of the screen to open the Dashboard, and then touch (**Wireless**).
2. Touch (**Setup**).
3. Touch **Wireless Settings**.
4. Touch **Wireless Setup Wizard** or **Wi-Fi Protected Setup**.
5. Follow the onscreen instructions to complete the setup.

If you are already using the printer with a different type of connection, such as a USB connection, follow the instructions in [Change the connection type](#) to set up the printer on your wireless network.

## Change the connection type

After you have installed the HP printer software and connected the printer to your computer or to a network, you can use the software to change the connection type (for example, from a USB connection to a wireless connection).

### To change from a USB connection to a wireless network (Windows)

Before you proceed, go through the list at [Before you begin](#).

1. Open the HP printer software. For more information, see [Open the HP printer software \(Windows\)](#).
2. Click **Tools**.
3. Click **Device Setup & Software**.
4. Select **Convert a USB connected printer to wireless**. Follow the onscreen instructions.

### To change from a USB connection to a wireless connection (OS X)

1. Connect the printer to your wireless network.
2. Use [123.hp.com](http://123.hp.com) to change the software connection to wireless for this printer.



Learn more about how to change from a USB to wireless connection. [Click here to go online for more information](#). At this time, this website might not be available in all languages.

### To change from a wireless connection to a USB connection (Windows)

- Connect the printer and the computer with the provided USB cable. This USB port is at the rear of the printer. For the specific location, see [Back view](#).

### To change from a wireless connection to a USB connection (OS X)



1. Open **System Preferences**.
2. Click **Printers & Scanners**.

3. Select your printer in the left pane and click - at the bottom of the list. Do the same for the fax entry, if there is one for the current connection.
4. Connect a USB cable to both your computer and printer.
5. Click + below the list of printers at the left.
6. Select the new USB printer from the list.
7. Choose your printer model name from the **Use** pop-up menu.
8. Click **Add**.

## Test the wireless connection



Print the wireless test report for information about the printer wireless connection. The wireless test report provides information about the printer status, hardware (MAC) address, and IP address. If there is a problem with the wireless connection or if a wireless connection attempt failed, the wireless test report also provides diagnostic information. If the printer is connected to a network, the test report displays details about the network settings.

### To print the wireless test report

1. From the printer control panel, touch or swipe down the tab at the top of the screen to open the Dashboard, touch  (**Wireless**), and then touch  (**Setup**).
2. Touch **Print Reports**.
3. Touch **Wireless Test Report**.

## Turn on or off the wireless capability of the printer

The blue Wireless light on the printer control panel is lit when the wireless capability of the printer is on.

1. From the printer control panel, touch or swipe down the tab at the top of the screen to open the Dashboard, touch  (**Wireless**), and then touch  (**Setup**).
2. Touch **Wireless Settings**.
3. Touch **Wireless** to switch it on or off.

## Change network settings

From the printer control panel, you can set up and manage your printer's wireless connection and perform a variety of network management tasks. This includes viewing and changing network settings, restoring network defaults, and turning the wireless function on or off.

---

 **CAUTION:** Network settings are provided for your convenience. However, unless you are an advanced user, you should not change some of these settings (such as IP settings, default gateway and firewall settings).

---

### To print network settings report

- ▲ From the printer control panel, touch or swipe down the tab at the top of the screen to open the Dashboard, touch  (**Setup**), touch **Reports**, and then touch **Network Configuration Page**.

## To change IP settings

The default IP setting for the IP settings is **Automatic**, which sets the IP settings automatically. If you are an advanced user and want to use different settings (such as the IP address, subnet mask, or the default gateway), you can change them manually.

 **TIP:** Before setting a manual IP address, it is recommended to first connect the printer to the network using Automatic mode. This allows the router to configure the printer with other needed settings like subnet mask, default gateway and DNS address.

 **CAUTION:** Be careful when manually assigning an IP address. If you enter an invalid IP address during the installation, your network components cannot connect with the printer.

1. From the printer control panel, touch or swipe down the tab at the top of the screen to open the Dashboard, touch  ( **Setup** ), and then touch **Network Setup**.

2. Touch **Wireless Settings**.

3. Touch **Advanced Settings**.

4. Touch **IP Settings**.

A message appears warning that changing the IP address removes the printer from the network. Touch **OK** to continue.

5. To change the settings manually, touch **Manual (Static)**, and then enter the appropriate information for the following settings:

- **IP Address**
- **Subnet Mask**
- **Default Gateway**
- **DNS Address**

6. Enter your changes, and then select **Apply**.

## Use Wi-Fi Direct

With Wi-Fi Direct, you can print wirelessly from a computer, smart phone, tablet, or other wireless-capable device—without connecting to an existing wireless network.

### Guidelines for using Wi-Fi Direct

- Make sure your computer or mobile device has the necessary software.
  - If you are using a computer, make sure you have installed the printer software provided with the printer.



If you have not installed the HP printer software on the computer, connect to Wi-Fi Direct first and then install the printer software. Select **Wireless** when prompted by the printer software for a connection type.
  - If you are using a mobile device, make sure you have installed a compatible printing app. For more information about mobile printing, visit [www.hp.com/go/mobileprinting](http://www.hp.com/go/mobileprinting).
- Make sure Wi-Fi Direct for your printer is turned on.
- Up to five computers and mobile devices can use the same Wi-Fi Direct connection.



- Wi-Fi Direct can be used while the printer is also connected either to a computer using a USB cable or to a network using a wireless connection.
- Wi-Fi Direct cannot be used to connect a computer, mobile device, or printer to the Internet.
- Wi-Fi Direct password: If the connection method of Wi-Fi Direct on the printer is set to **Automatic**, the password will always be '12345678'. If the connection method of Wi-Fi Direct on the printer is set to **Manual**, the password will be a randomly generated 8-digit code.

To obtain the Wi-Fi Direct password of the printer, from the printer control panel, touch  (**Wi-Fi Direct**). The Wi-Fi Direct password will be displayed on the control panel display.

### To turn on Wi-Fi Direct

1. From the printer control panel, touch or swipe down the tab at the top of the screen to open the Dashboard, and then touch  (**Wi-Fi Direct**).
2. Touch  (**Setup**).
3. If the display shows that Wi-Fi Direct is **Off**, touch **Wi-Fi Direct** and then switch it on.

---

 **TIP:** You can also turn on Wi-Fi Direct from the EWS. For more information about using the EWS, see [Embedded web server](#).

---

### To print from a wireless-capable mobile device that supports Wi-Fi Direct

Make sure you have installed the latest version of HP Print Service Plugin on your mobile device. You can download this plugin from the Google Play store.

1. Make sure you have turned on Wi-Fi Direct on the printer.
2. Turn on Wi-Fi Direct on your mobile device. For more information, see the documentation provided with the mobile device.
3. From your mobile device, select a document from a print enabled application, and then select the option to print the document.

The list of available printers appears.

4. From the list of available printers, choose the Wi-Fi Direct name shown such as **DIRECT-\*\*-HP OfficeJet XXXX** (where \*\* are the unique characters to identify your printer and XXXX is the printer model located on the printer), and then follow the onscreen instructions on the printer and your mobile device.

If the mobile device is not automatically connected to the printer, follow the instructions on the printer control panel to connect to the printer. If a PIN code is displayed on the printer control panel, enter the PIN code on your mobile device.

When the mobile device is successfully connected to the printer, the printer starts printing.

### To print from a wireless-capable mobile device that does not support Wi-Fi Direct

Make sure you have installed a compatible printing app on your mobile device. For more information, visit [www.hp.com/go/mobileprinting](http://www.hp.com/go/mobileprinting).

If a local version of this website is not available in your country/region or language, you might be directed to the HP Mobile Printing site in another country/region or language.

1. Make sure you have turned on Wi-Fi Direct on the printer.
2. Turn on the Wi-Fi connection on your mobile device. For more information, see the documentation provided with the mobile device.



---

**NOTE:** If your mobile device does not support Wi-Fi, you are not able to use Wi-Fi Direct.

---

3. From the mobile device, connect to a new network. Use the process you normally use to connect to a new wireless network or hotspot. Choose the Wi-Fi Direct name from the list of wireless networks shown such as **DIRECT-\*\*-HP OfficeJet XXXX** (where \*\* are the unique characters to identify your printer and XXXX is the printer model located on the printer).

Enter the Wi-Fi Direct password when prompted.

4. Print your document.

### To print from a wireless-capable computer (Windows)

1. Make sure you have turned on Wi-Fi Direct on the printer.
2. Turn on the computer's Wi-Fi connection. For more information, see the documentation provided with the computer.



---

**NOTE:** If your computer does not support Wi-Fi, you are not able to use Wi-Fi Direct.

---

3. From the computer, connect to a new network. Use the process you normally use to connect to a new wireless network or hotspot. Choose the Wi-Fi Direct name from the list of wireless networks shown such as **DIRECT-\*\*-HP OfficeJet XXXX** (where \*\* are the unique characters to identify your printer and XXXX is the printer model located on the printer).

Enter the Wi-Fi Direct password when prompted.

4. Proceed to step 5 if the printer has been installed and connected to the computer over a wireless network. If the printer has been installed and connected to your computer with a USB cable, follow the steps below to install the printer software using the Wi-Fi Direct connection.
  - a. Open the HP printer software. For more information, see [Open the HP printer software \(Windows\)](#).
  - b. Click **Tools**.
  - c. Click **Device Setup & Software**, and then select **Connect a new printer**.



---

**NOTE:** If you have previously installed the printer over USB and want to convert to Wi-Fi Direct, do not select the **Convert a USB connected printer to wireless** option.

---

- d. When the **Connection Options** software screen appears, select **Wireless**.
  - e. Select your HP printer from the detected printer list.
  - f. Follow the onscreen instructions.
5. Print your document.

### To print from a wireless-capable computer (OS X)

1. Make sure you have turned on Wi-Fi Direct on the printer.
2. Turn on Wi-Fi on the computer.

For more information, see the documentation provided by Apple.

3. Click the Wi-Fi icon and choose the Wi-Fi Direct name, such as **DIRECT-\*\*-HP OfficeJet XXXX** (where \*\* are the unique characters to identify your printer and XXXX is the printer model located on the printer).  
If Wi-Fi Direct is turned on with security, enter the password when prompted.
4. Add the printer.
  - a. Open **System Preferences**.
  - b. Depending on your operating system, click **Printers & Scanners**.
  - c. Click + below the list of printers at the left.
  - d. Select the printer from the list of detected printers (the word “Bonjour” is listed the right column beside the printer name), and click **Add**.



[Click here for online troubleshooting for Wi-Fi Direct](#), or for more help with setting up Wi-Fi Direct. At this time, this website might not be available in all languages.



Learn more about how to change from a USB to wireless connection. [Click here to go online for more information](#). At this time, this website might not be available in all languages.

## Easily connect and print with Bluetooth® Smart

With the Bluetooth Smart technology, you can easily connect your mobile device to your printer and start printing. Simply walk up to the printer, select the file you want to print using the HP ePrint app, and then select the print option. The mobile device will connect to the printer automatically.



**NOTE:** Bluetooth Smart is currently supported on Android mobile devices that support Bluetooth v4.0+ and that have the HP ePrint app installed. For more information, visit [www.hp.com/go/blueprinting](http://www.hp.com/go/blueprinting).

### To connect and print using Bluetooth Smart technology

1. Set up your mobile device and printer to enable Bluetooth Smart connections.
  - On your mobile device, turn on Wi-Fi and Bluetooth and install the HP ePrint app from the Google Play store. For more information, see the documentation provided with the mobile device.
  - On the printer, make sure Bluetooth Smart and Wi-Fi Direct are turned on. For more information, see [Use Wi-Fi Direct](#) and [To turn on or off Bluetooth Smart on the printer](#).
2. Walk up to within arm’s reach of the printer.
3. Open the HP ePrint app on the mobile device and select the desired content to print.
4. Confirm the correct printer is selected by the app, and select **Print**.

### To turn on or off Bluetooth Smart on the printer

The Bluetooth feature is on by default if wireless is turned on.

1. From the printer control panel, touch or swipe down the tab at the top of the screen to open the Dashboard, and then touch  (**Setup**).
2. Scroll down to touch the Bluetooth option, and then turn it on or off.

---

# 8 Printer management tools

This section contains the following topics:

- [Toolbox \(Windows\)](#)
- [HP Utility \(OS X\)](#)
- [Embedded web server](#)

## Toolbox (Windows)

The Toolbox provides maintenance information about the printer.



---

**NOTE:** The Toolbox can be installed from the HP Software CD if the computer meets the system requirements. System requirements can be found in the Readme file, which is available on the HP printer software CD provided with your printer.

---

### To open the Toolbox

1. Open the HP printer software. For more information, see [Open the HP printer software \(Windows\)](#).
2. Click **Print & Scan**.
3. Click **Maintain Your Printer**.

## HP Utility (OS X)

HP Utility contains tools to configure print settings, calibrate the printer, order supplies online, and find website support information.



---

**NOTE:** The features available in HP Utility vary depending on the selected printer.

---

Double-click HP Utility in the **HP** folder in the **Applications** folder at the top level of the hard disk.

## Embedded web server

When the printer is connected to a network, you can use the printer's embedded web server (EWS) to view status information, change settings, and manage it from your computer.



---

**NOTE:**

- To view or change some settings, you might need a password.
  - You can open and use the embedded web server without being connected to the Internet. However, some features are not available.
- 
- [About cookies](#)
  - [Open the embedded web server](#)
  - [Embedded web server cannot be opened](#)

## About cookies

The embedded Web server (EWS) places very small text files (cookies) on your hard drive when you are browsing. These files let the EWS recognize your computer the next time you visit. For example, if you have configured the EWS language, a cookie helps remember which language you have selected so that the next time you access the EWS, the pages are displayed in that language. Some cookies (such as the cookie that stores customer-specific preferences) are stored on the computer until you clear them manually.

You can configure your browser to accept all cookies, or you can configure it to alert you every time a cookie is offered, which allows you to decide which cookies to accept or refuse. You can also use your browser to remove unwanted cookies.

Depending on your printer, if you disable cookies, you also disable one or more of the following features:

- Using some setup wizards
- Remembering the EWS browser language setting
- Personalizing the EWS Home page

For information about how to change your privacy and cookie settings and how to view or delete cookies, see the documentation available with your Web browser.

## Open the embedded web server



You can access the embedded web server through either a network or Wi-Fi Direct.

### To open the embedded web server through a wireless network

1. Make sure both your printer and computer are connected to the same wireless network.
2. From the printer control panel, touch  (**Wireless**) to find out the IP address or hostname of the printer.
3. Type such IP address or hostname in a supported web browser on your computer.

For example, if the IP address is 123.123.123.123, type the following address into the web browser:  
`http://123.123.123.123.`

### To open the embedded web server through Wi-Fi Direct

1. From the printer control panel, touch  (**Wi-Fi Direct**).
2. Skip this step if the display shows the Wi-Fi Direct is on.  
  
Touch  (**Settings**), and then choose **On** for the **Wi-Fi Direct** option.
3. From your wireless computer, turn wireless on, search for and connect to the Wi-Fi Direct name, for example: **DIRECT-\*\*-HP OfficeJet XXXX** (where \*\* are the unique characters to identify your printer and XXXX is the printer model located on the printer).
4. Enter the Wi-Fi Direct password when prompted on your computer.
5. In a supported web browser on your computer, type `http://192.168.223.1` into the web browser.

## Embedded web server cannot be opened

1. Restart your network router.
2. Wait until your computer and network have both reconnected to the network successfully.
3. Access the printer's EWS again.

### Check your network

- Make sure you are not using a phone cord or a crossover cable to connect the printer to the network.

### Check the computer

- Make sure the computer that you are using is connected to the same network as the printer.



**NOTE:** You may also access the printer's EWS if the computer is connected to the printer through Wi-Fi Direct. For information about how to access EWS through Wi-Fi Direct, see [Embedded web server](#)

### Check your web browser

- Make sure the web browser meets the minimum system requirements. For more information, see system requirements in the printer's Readme file found on the HP printer software CD.
- If your web browser uses any proxy settings to connect to the Internet, try turning off these settings. For more information, see the documentation available with your web browser.
- Make sure JavaScript and cookies are enabled in your web browser. For more information, see the documentation available with your web browser.

### Check the printer IP address

- To check the IP address of the printer, you can print a wireless test report. For more information about the wireless test report, see [Test the wireless connection](#).
- Ping the printer using the IP address from the command prompt (Windows) or from Network Utility (OS X).



**NOTE:** To find Network Utility from OS X, click the icon **Spotlight**, and then type **Network Utility** into the search field.

For example, if the IP address is 123.123.123.123, type the following at the command prompt (Windows):

```
C:\ping 123.123.123.123
```

Or

In Network Utility (OS X), click the **Ping** tab, type the 123.123.123.123 in the box, and then click **Ping**.

If a reply appears, the IP address is correct. If a time-out response appears, the IP address is incorrect.



**TIP:** If you are using a computer running Windows, you can visit the HP online support website at [www.hp.com/support](http://www.hp.com/support). This website provides information and utilities that can help you correct many common printer problems.

---

# 9 Solve a problem

The information in this section suggests solutions to common problems. If your printer is not operating correctly and these suggestions did not solve your problem, try using one of the support services listed in [HP support](#) to obtain assistance.

This section contains the following topics:

- [Jams and paper-feed issues](#)
- [Printing issues](#)
- [Copy issues](#)
- [Scan issues](#)
- [Network and connection issues](#)
- [Printer hardware issues](#)
- [Get help from the printer control panel](#)
- [Understand printer reports](#)
- [Solve problems using Web Services](#)
- [Maintain the printer](#)
- [Restore original factory defaults and settings](#)
- [HP support](#)

## Jams and paper-feed issues

What do you want to do?

### Clear a paper jam

<a href="#">Solve paper jam issues</a>	Use an HP online troubleshooting wizard. Instructions for clearing paper jam and resolving issues with paper or the paper feed.
--	--

---

 **NOTE:** The HP online troubleshooting wizards may not be available in all languages.

---

### Read general instructions in the Help for clearing paper jams

Paper jams can occur in several locations inside the printer.

---

 **CAUTION:** To prevent possible damage to the cartridge, clear paper jams as soon as possible.

---

### To clear a paper jam from input tray and output slot

1. Remove paper that is not jammed from both the input tray and output slot.
2. If paper is jammed in the input tray or output slot, slowly and steadily pull it out to avoid paper tear. If you cannot remove it, it should be jammed in the printing area. Go through next steps.
3. Open the cartridge access door.
4. Remove all visible paper by moving the cartridges around from one side to the other.  
If the issue is not resolved, use [HP online troubleshooting wizard](#) to resolve the cartridge jams.
5. Close the cartridge access door.
6. Check to make sure all jammed and torn pieces of paper are cleared. Otherwise, more paper jams will occur.
7. (Option) If the print carriage does not return to the left side of the printer, turn the printer off and on again.

### To clear a paper jam from the document feeder

1. Lift the cover of the document feeder.



2. Pull any jammed paper out of the rollers.

**⚠ CAUTION:**

- If the paper tears when you are removing it from the rollers, check the rollers and wheels for torn pieces of paper that might remain inside the printer.
- If you do not remove all the pieces of paper from the printer, more paper jams are likely to occur.



3. Close the cover of the document feeder until it snaps into space.

### To clear a paper jam from the print carriage area

1. Open the cartridge access door.



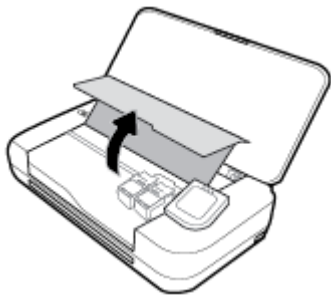

2. Remove all visible paper by moving the cartridges around from one side to the other.

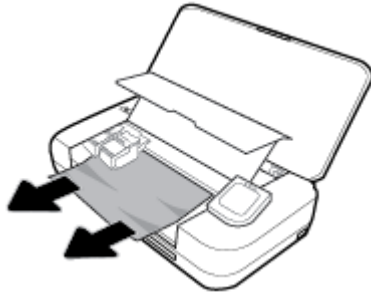

3. Close the cartridge access door.

## Learn how to avoid paper jams

To help avoid paper jams, follow these guidelines.

- Remove printed papers from the output slot frequently.
- Make sure that you are printing with paper that is not wrinkled, folded, or damaged.
- Prevent curled or wrinkled paper by storing all unused paper flat in a resealable bag.
- Do not use paper that is too thick or too thin for the printer.
- Make sure that the paper is loaded correctly. For more information, see [Load paper](#).
- Ensure that paper loaded in the input tray lays flat and the edges are not bent or torn.
- Do not place too much paper in the input tray. For information on the maximum number of sheets allowed in the input tray, see [Specifications](#).
- When loading a stack of paper, fan the pages first.
- Do not combine different paper types and paper sizes in the input tray; the entire stack of paper in the input tray must be the same size and type.
- Adjust the paper-width guides in the input tray to fit snugly against all paper. Make sure the paper-width guides do not bend the paper in the input tray.
- Do not force paper too far inside the input tray.
- If you are printing on both sides of a page, do not print highly saturated images on light weight paper.
- Use paper types that are recommended for the printer.
- If the printer is about to run out of paper, allow the printer to run out of paper first, and then add paper. Do not load paper when the printer is printing.

## Solve paper-feed problems

What kind of problem are you having?

- **Paper is not picked up from the input tray**
  - Make sure paper is loaded in the input tray. For more information, see [Load paper](#). Fan the paper before loading.
  - Make sure the paper-width guides are snug, but not tight, against the paper.
  - Make sure paper in use is not curled. Uncurl paper by bending it in the opposite direction of the curl.
- **Pages are skewing**
  - Make sure the paper loaded in the input tray is aligned to the paper-width guides.
  - Load paper into the printer only when it is not printing.
- **Multiple pages are being picked up**
  - Make sure the paper-width guides are snug, but not tight, against the stack of paper.
  - Make sure the input tray is not overloaded with paper.
  - Use HP paper for optimum performance and efficiency.

## Printing issues

What do you want to do?

### Fix problems with page not printing (unable to print)

<a href="#">HP Print and Scan Doctor</a>	The HP Print and Scan Doctor is a utility that will try to diagnose and fix the issue automatically. <b>NOTE:</b> This utility is only available for Windows operation system.
<a href="#">Troubleshoot problems with print jobs not printing</a>	Use an HP online troubleshooting wizard. Get step-by-step instructions if the printer is not responding or printing.



**NOTE:** The HP Print and Scan Doctor and the HP online troubleshooting wizards may not be available in all languages.

### Read general instructions in the Help for unable to print issues

#### To resolve print issues (Windows)

Make sure that the printer is turned on and that there is paper in the tray. If you are still unable to print, try the following in order:

1. Check for error messages from the printer display and resolve them by following the onscreen instructions.
2. If your computer is connected to the printer with a USB cable, disconnect and reconnect the USB cable. If your computer is connected to the printer with a wireless connection, confirm that the connection is working.
3. Verify that the printer is not paused or offline.

#### To verify that the printer is not paused or offline

- a. Depending on your operating system, do one of the following:
    - **Windows 10:** From the Windows **Start** menu, click **All apps**, click **Windows System**, click **Control Panel**, and then click **View devices and printers** under **Hardware and Sound** menu.
    - **Windows 8.1 and Windows 8:** Point to or tap the upper-right corner of the screen to open the Charms bar, click the **Settings** icon, click or tap **Control Panel**, and then click or tap **View devices and printers**.
    - **Windows 7:** From the Windows **Start** menu, click **Devices and Printers**.
    - **Windows Vista:** From the Windows **Start** menu, click **Control Panel**, and then click **Printers**.
    - **Windows XP:** From the Windows **Start** menu, click **Control Panel**, and then click **Printers and Faxes**.
  - b. Either double-click the icon for your printer or right-click the icon for your printer and select **See what's printing** to open the print queue.
  - c. On the **Printer** menu, make sure there are no check marks next to **Pause Printing** or **Use Printer Offline**.
  - d. If you made any changes, try to print again.
4. Verify that the printer is set as the default printer.

#### To verify that the printer is set as the default printer

- a. Depending on your operating system, do one of the following:
    - **Windows 10:** From the Windows **Start** menu, click **All apps**, click **Windows System**, click **Control Panel**, and then click **View devices and printers** under **Hardware and Sound** menu.
    - **Windows 8.1 and Windows 8:** Point to or tap the upper-right corner of the screen to open the Charms bar, click the **Settings** icon, click or tap **Control Panel**, and then click or tap **View devices and printers**.
    - **Windows 7:** From the Windows **Start** menu, click **Devices and Printers**.
    - **Windows Vista:** From the Windows **Start** menu, click **Control Panel**, and then click **Printers**.
    - **Windows XP:** From the Windows **Start** menu, click **Control Panel**, and then click **Printers and Faxes**.
  - b. Make sure the correct printer is set as the default printer.  
The default printer has a check mark in a black or green circle next to it.
  - c. If the wrong printer is set as the default printer, right-click the correct printer and select **Set as Default Printer**.
  - d. Try using your printer again.
5. Restart the print spooler.

#### To restart the print spooler

- a. Depending on your operating system, do one of the following:

## Windows 10

- i. From the Windows **Start** menu, click **All apps**, and then click **Windows System**.
- ii. Click **Control Panel, System and Security**, and then click **Administrative Tools**.
- iii. Double-click **Services**.
- iv. Right-click the **Print Spooler**, and then click **Properties**.
- v. On the **General** tab, next to **Startup type**, make sure that **Automatic** is selected.
- vi. If the service is not already running, under **Service status**, click **Start**, and then click **OK**.

## Windows 8.1 and Windows 8

- i. Point to or tap the upper-right corner of the screen to open the Charms bar, and then click the **Settings** icon.
- ii. Click or tap **Control Panel**, and then click or tap **System and Security**.
- iii. Click or tap **Administrative Tools**, and then double-click or double-tap **Services**.
- iv. Right-click or touch and hold **Print Spooler**, and then click **Properties**.
- v. On the **General** tab, next to **Startup type**, make sure that **Automatic** is selected.
- vi. If the service is not already running, under **Service status**, click or tap **Start**, and then click or tap **OK**.

## Windows 7

- i. From the Windows **Start** menu, click **Control Panel, System and Security**, and then **Administrative Tools**.
- ii. Double-click **Services**.
- iii. Right-click the **Print Spooler**, and then click **Properties**.
- iv. On the **General** tab, next to **Startup type**, make sure that **Automatic** is selected.
- v. If the service is not already running, under **Service status**, click **Start**, and then click **OK**.

## Windows Vista

- i. From the Windows **Start** menu, click **Control Panel, System and Maintenance, Administrative Tools**.
- ii. Double-click **Services**.
- iii. Right-click the **Print Spooler service**, and then click **Properties**.
- iv. On the **General** tab, next to **Startup type**, make sure that **Automatic** is selected.
- v. If the service is not already running, under **Service status**, click **Start**, and then click **OK**.

## Windows XP

- i. From the Windows **Start** menu, right click **My Computer**.
- ii. Click **Manage**, and then click **Services and Applications**.

- iii. Double-click **Services**, and then select **Print Spooler**.
      - iv. Right-click **Print Spooler**, and click **Restart** to restart the service.
    - b. Make sure the correct printer is set as the default printer.

The default printer has a check mark in a black or green circle next to it.
    - c. If the wrong printer is set as the default printer, right-click the correct printer and select **Set as Default Printer**.
    - d. Try using your printer again.
  - 6. Restart the computer.
  - 7. Clear the print queue.

#### To clear the print queue

- a. Depending on your operating system, do one of the following:
  - **Windows 10:** From the Windows **Start** menu, click **All apps**, click **Windows System**, click **Control Panel**, and then click **View devices and printers** under **Hardware and Sound** menu.
  - **Windows 8.1 and Windows 8:** Point to or tap the upper-right corner of the screen to open the Charms bar, click the **Settings** icon, click or tap **Control Panel**, and then click or tap **View devices and printers**.
  - **Windows 7:** From the Windows **Start** menu, click **Devices and Printers**.
  - **Windows Vista:** From the Windows **Start** menu, click **Control Panel**, and then click **Printers**.
  - **Windows XP:** From the Windows **Start** menu, click **Control Panel**, and then click **Printers and Faxes**.
- b. Double-click the icon for your printer to open the print queue.
- c. On the **Printer** menu, click **Cancel all documents** or **Purge Print Document**, and then click **Yes** to confirm.
- d. If there are still documents in the queue, restart the computer and try printing again after the computer has restarted.
- e. Check the print queue again to make sure it is clear, and then try to print again.

#### To check the power connection and reset the printer

- 1. Make sure the power cord is firmly connected to the printer.



- 
- |   |                                 |
|---|---------------------------------|
| 1 | Power connection to the printer |
| 2 | Connection to a power outlet    |
- 

2. Look at the Power button located on the printer. If it is not lit, the printer is turned off. Press the Power button to turn on the printer.



**NOTE:** If the printer is not receiving electrical power, connect it to another power outlet.

3. With the printer turned on, disconnect the power cord from the side of the printer.
4. Unplug the power cord from the wall outlet.
5. Wait at least 15 seconds.
6. Plug the power cord back into the wall outlet.
7. Reconnect the power cord to the side of the printer.
8. If the printer does not turn on by itself, press the Power button to turn on the printer.
9. Try using the printer again.

### To resolve print issues (OS X)

1. Check for error messages and resolve.
2. Disconnect and reconnect the USB cable.
3. Verify that the product is not paused or offline.

#### To verify that the product is not paused or offline

- a. In **System Preferences**, click **Printers & Scanners**.
- b. Click the **Open Print Queue** button.
- c. Click a print job to select it.

Use the following buttons to manage the print job:

- **Delete:** Cancel the selected print job.
- **Hold:** Pause the selected print job.
- **Resume:** Continue a paused print job.
- **Pause Printer:** Pause all print jobs in the print queue.

- d. If you made any changes, try to print again.
4. Restart the computer.

## Fix print quality issues

[Step-by-step instructions for resolving most print quality issues](#)

[Troubleshoot print quality issues online](#)

### Read general instructions in the Help for resolving print quality issues

 **NOTE:** To avoid print quality problems, always turn the printer off using the Power button, and wait until the Power button light goes out before you pull the plug or turn off a power strip. This allows the printer to move the cartridges to a capped position, where they are protected from drying out.

#### To improve print quality

1. Make sure you are using original HP cartridges.
2. Make sure you are using an appropriate paper type.

Always make sure the paper you are printing on is flat and is not damaged, curled, or wrinkled. For more information, see [Tips for selecting and using paper](#).

For best print quality, use high quality HP paper, or papers that adhere to the ColorLok® standard. For more information, see [Paper basics](#).

For best results when printing images, use HP Advanced Photo Paper.

Store specialty paper in its original packaging inside a resealable plastic bag on a flat surface in a cool, dry place.

When you are ready to print, remove only the paper you plan to use immediately. When you have finished printing, return any unused photo paper to the plastic bag. This prevents the photo paper from curling.

3. Make sure you have selected the appropriate paper type and print resolution in the software print settings.

 **NOTE:** Selecting a higher print quality can result in a printout with higher definition but could use more ink and take longer to print.

4. Check the estimated ink levels to determine if the cartridges are low on ink. For more information, see [Check the estimated ink levels](#). If the cartridges are low on ink, consider replacing them.

#### To improve print quality (Windows)

##### a. To print a diagnostics page

Print a diagnostics page if the cartridges are not low on ink.

- i. Load Letter or A4 plain, white paper in the input tray.
- ii. Open the HP printer software. For more information, see [Open the HP printer software \(Windows\)](#).
- iii. In the printer software, click **Print & Scan**, and then click **Maintain Your Printer** to access the **Printer Toolbox**.
- iv. Click **Print Diagnostic Information** on the **Device Reports** tab to print a diagnostics page.

##### b. To clean the cartridges or printhead

Review the blue, magenta, yellow, and black boxes on the diagnostics page. If you are seeing streaks in the color and black boxes, or no ink in portions of the boxes, then automatically clean the printhead.

- i. Load Letter or A4 plain, white paper in the input tray.
- ii. Open the HP printer software. For more information, see [Open the HP printer software \(Windows\)](#).
- iii. In the printer software, click **Print & Scan**, and then click **Maintain Your Printer** to access the **Printer Toolbox**.
- iv. From the **Device Services** tab, click the option to clean, and then follow the onscreen instructions.

If cleaning the cartridges or printhead does not solve the problem, contact HP support. Go to [www.hp.com/support](http://www.hp.com/support). This website provides information and utilities that can help you correct many common printer problems. If prompted, select your country/region, and then click **All HP Contacts** for information on calling for technical support.

**c. To align the cartridges or printhead**



---

**NOTE:** Aligning the printhead ensures the high-quality output. The printhead does not have to be realigned when cartridges are replaced.

---

- i. Load Letter or A4 plain, white paper in the input tray.
- ii. Open the HP printer software. For more information, see [Open the HP printer software \(Windows\)](#).
- iii. In the printer software, click **Print & Scan**, and then click **Maintain Your Printer** to access the **Printer Toolbox**.
- iv. From the **Device Service** tab, click the option to align.
- v. The printer prints an alignment sheet.
- vi. Follow the instructions on the printer screen to align.

**To improve print quality (OS X)**

**a. To print a diagnostics page**

- i. Load Letter or A4 plain, white paper in the input tray.
  - ii. Open **HP Utility**.
- 
-  **NOTE:** **HP Utility** is located in the **HP** folder in the **Applications** folder.
- 
- iii. Select your printer from the list of devices at the left of the window.
  - iv. Click **Test Page**.
  - v. Click the **Print Test Page** button, and follow the onscreen instructions.

**b. To clean the cartridges or printhead**

- i. Load Letter or A4 plain, white paper in the input tray.
  - ii. Open **HP Utility**.
- 
-  **NOTE:** **HP Utility** is located in the **HP** folder in the **Applications** folder.
- 
- iii. Select your printer from the list of devices at the left of the window.



- iv. Click **Clean Printheads**.
- v. Click **Clean**, and follow the onscreen instructions.

---

 **CAUTION:** Clean the cartridges or printhead only when necessary. Unnecessary cleaning wastes ink and shortens the life of the printhead.

 **NOTE:** If print quality still seems poor after you complete cleaning, try aligning the printhead. If print quality problems persist after cleaning and aligning, contact HP support.

---

- vi. Click **All Settings** to return to the **Information and Support** pane.

**c. To align the cartridges or printhead**

- i. Load Letter or A4 plain, white paper in the input tray.
- ii. Open **HP Utility**.

---

 **NOTE:** **HP Utility** is located in the **HP** folder in the **Applications** folder.

---

- iii. Select your printer from the list of devices at the left of the window.
- iv. Click **Align**.
- v. Click **Align**, and follow the onscreen instructions.
- vi. Click **All Settings** to return to the **Information and Support** pane.

**To improve print quality (printer control panel)**

**a. To print a diagnostics page**

- i. Load Letter or A4 plain, white paper in the input tray.
- ii. From the printer control panel, touch or swipe down the tab at the top of the screen to open the Dashboard, and then touch  (**Setup**).
- iii. Touch **Reports**.
- iv. Touch **Print Quality Report**.

**b. To clean the cartridges or printhead**

- i. Load Letter or A4 plain, white paper in the input tray.
- ii. From the printer control panel, touch or swipe down the tab at the top of the screen to open the Dashboard, and then touch  (**Setup**).
- iii. Touch **Printer Maintenance**.
- iv. Select the option to clean, and then follow the onscreen instructions

**c. To align the cartridges or printhead**

- i. Load Letter or A4 plain, white paper in the input tray.
- ii. From the printer control panel, touch or swipe down the tab at the top of the screen to open the Dashboard, and then touch  (**Setup**).
- iii. Select the option to align, and then follow the onscreen instructions.

## Copy issues

<a href="#">Troubleshoot copy problems</a>	Use an HP online troubleshooting wizard. Get step-by-step instructions if the printer does not create a copy, or if your printouts are low quality.
--	--



**NOTE:** The HP online troubleshooting wizards may not be available in all languages.

[Tips for copy and scan success](#)

## Scan issues

<a href="#">HP Print and Scan Doctor</a>	The HP Print and Scan Doctor is a utility that will try to diagnose and fix the issue automatically. <b>NOTE:</b> This utility is only available for Windows operating system.
<a href="#">Solve scan problems</a>	Use an HP online troubleshooting wizard. Get step-by-step instructions if you cannot create a scan or if your scans are low quality.



**NOTE:** The HP Print and Scan Doctor and the HP online troubleshooting wizards may not be available in all languages.

[Tips for copy and scan success](#)

## Network and connection issues

What do you want to do?

### Fix wireless connection

Choose one of the following troubleshooting options.



<a href="#">HP Print and Scan Doctor</a>	The HP Print and Scan Doctor is a utility that will try to diagnose and fix the issue automatically. <b>NOTE:</b> This utility is only available for Windows operating system.
Use an HP online troubleshooting wizard	<ul style="list-style-type: none"><li>• <a href="#">Troubleshoot your wireless problem</a>, whether your printer has never been connected or it was connected and is no longer working.</li><li>• <a href="#">Troubleshoot a firewall or antivirus issue</a>, if you suspect that it is preventing your computer from connecting to the printer.</li></ul>



**NOTE:** The HP Print and Scan Doctor and the HP online troubleshooting wizards may not be available in all languages.

## Read general instructions in the Help for wireless troubleshooting

Check the network configuration or print the wireless test report to assist in diagnosing network connection issues.

1. From the Home screen, touch  (**Wireless**) and then touch  (**Setup**).
2. Touch **Print Reports**, and then touch **Network Configuration Page** or **Wireless Test Report**.

## Find network settings for wireless connection

Choose one of the following troubleshooting options.

<a href="#">HP Print and Scan Doctor</a>	The HP Print and Scan Doctor is a utility that can tell you the network name (SSID) and password (network key).  <b>NOTE:</b> This utility is only available for Windows operating system. The Windows computer you are running the HP Print and Scan Doctor on should be connected to the network using a wireless connection.  To check the wireless settings, open the HP Print and Scan Doctor, click on the <b>Network</b> tab at the top, select <b>Show Advanced Info</b> , and then select <b>Show Wireless Info</b> . You can also find the wireless settings by clicking on the <b>Network</b> tab at the top and selecting <b>Open router web page</b> .
<a href="#">Use an HP online troubleshooting wizard</a>	Learn how to find your network name (SSID) and wireless password.

 **NOTE:** The HP Print and Scan Doctor and the HP online troubleshooting wizards may not be available in all languages.

## Fix Wi-Fi Direct connection

<a href="#">Use an HP online troubleshooting wizard</a>	Troubleshoot your Wi-Fi Direct problem or learn how to configure Wi-Fi Direct.
---	--

 **NOTE:** The HP online troubleshooting wizards may not be available in all languages.

## Read general instructions in the Help for Wi-Fi Direct troubleshooting

1. Check the printer to confirm that Wi-Fi Direct is turned on:
  - ▲ From the printer control panel, touch or swipe down the tab at the top of the screen to open the Dashboard, and then touch  (**Wi-Fi Direct**).
2. From your wireless computer or mobile device, turn on the Wi-Fi connection, and then search for and connect to the Wi-Fi Direct name of your printer.
3. Enter the Wi-Fi Direct password when prompted.
4. If you are using a mobile device, make sure you have installed a compatible printing app. For more information about mobile printing, visit [www.hp.com/go/mobileprinting](http://www.hp.com/go/mobileprinting).

If a local version of this website is not available in your country/region or language, you might be directed to the HP Mobile Printing site in another country/region or language.

# Printer hardware issues

 **TIP:** Run the [HP Print and Scan Doctor](#) to diagnose and automatically fix printing issues. The application is only available in some languages.

## The printer shuts down unexpectedly



- If the printer is connected to the power:
  - Check the power and power connections. Make sure the printer's power cord is connected firmly to a functioning power outlet.
- If the printer is disconnected from the power:
  - Make sure the battery is installed properly.
  - Check the battery status. For more information, see [Charge the battery](#).

## Printer alignment fails

- If the alignment process fails, make sure you have loaded unused, plain white paper into the input tray. If you have colored paper loaded in the input tray when you align the printer, the alignment fails.
- If the alignment process fails repeatedly, you may need to clean the cartridge, or you might have a defective sensor. To clean the cartridge, see [Maintain the cartridge and printer](#).
- If cleaning the cartridge does not solve the problem, contact HP support. Go to [www.hp.com/support](http://www.hp.com/support). This website provides information and utilities that can help you correct many common printer problems. If prompted, select your country/region, and then click **All HP Contacts** for information on calling for technical support.

## Resolve printer failure

Complete the following steps to resolve such problems.

1. Press  (**Power**) to turn off the printer.
2. Unplug the power cord.
3. Remove the battery if a battery has been installed.
4. Plug in the power cord.
5. Press  (**Power**) to turn on the printer.
6. Install the battery.

If this problem persists, write down the error code provided in the message, and then contact HP support. For more information about contacting HP support, see [HP support](#).

## Get help from the printer control panel

You can use the printer's help topics to learn more about the printer, and some help topics include animations that guide you through procedures.

To access the Help menu from the Home screen or contextual help for a screen, touch  (**Help**) on the printer control panel.

## Understand printer reports

You can print the following reports to help troubleshoot problems with the printer.

- [Printer status report](#)
- [Network configuration page](#)
- [Print quality report](#)

### To print a printer report

1. From the printer control panel, touch or swipe down the tab at the top of the screen to open the Dashboard, touch  (**Setup**).
2. Touch **Reports**.
3. Select a printer report to print.

### Printer status report

Use the printer status report to view current printer information and cartridge status. Also use the printer status report to help you troubleshoot problems with the printer.

The printer status report also contains a log of recent events.

If you need to call HP, it is often useful to print the printer status report before calling.

### Network configuration page

If the printer is connected to a network, you can print a network configuration page to view the network settings for the printer and a list of networks detected by your printer. The last page of the report includes a list of all detectable wireless networks in the area, along with signal strength and the channels being used. This might help you select a channel for your network which is not heavily used by other networks (which will improve network performance).

You can use the network configuration page to help troubleshoot network connectivity problems. If you need to call HP, it is often useful to print this page before calling.

### Print quality report

Print quality problems can have many causes—software settings, a poor image file, or the printing system itself. If you are unhappy with the quality of your prints, a Print Quality Report page can help you determine if the printing system is working correctly.

## Solve problems using Web Services

If you are having problems using Web Services, such as **HP ePrint** and print apps, check the following:

- Make sure the printer is connected to the Internet.



---

**NOTE:** You cannot use these web features if the printer is connected using a USB cable.

---

- Make sure the latest product updates have been installed on the printer.
- Make sure Web Services is enabled on the printer. For more information, see [Set up Web Services](#).
- If you are connecting the printer using a wireless connection, make sure the wireless network is functioning properly. For more information, see [Network and connection issues](#).

- If you are using **HP ePrint**, check the following:
    - Make sure the printer's email address is correct.
    - Make sure that the printer's email address is the only address listed in the “To” line of the email message. If other email addresses are listed in the “To” line, the attachments you are sending might not print.
    - Make sure you are sending documents that meet the **HP ePrint** requirements. For more information, visit [HP Connected](#). This site might not be available in all countries/regions.
  - If your network uses proxy settings when connecting to the Internet, make sure the proxy settings you are entering are valid:
    - Check the settings being used by the web browser you are using (such as Internet Explorer, Firefox, or Safari).
    - Check with the IT administrator or person who set up your firewall.

If the proxy settings used by your firewall have changed, you must update these settings in either the printer control panel or the embedded web server. If these settings are not updated, you will not be able to use Web Services.
- For more information, see [Set up Web Services](#).

---

 **TIP:** For additional help on setting up and using Web Services, visit [HP Connected](#). This site might not be available in all countries/regions.



---

## Maintain the printer

What do you want to do?

### Clean the exterior

---

 **WARNING!** Before cleaning the printer, turn the printer off by pressing  (**Power**), unplug the power cord from the electrical socket, and remove the battery (if installed).

---



Use a soft, damp, lint-free cloth to wipe dust, smudges, and stains off of the case. Keep fluids away from the interior of the printer, as well as from the printer control panel.

### Clean the document feeder

When the printer scans the document, smudges or dust on the scan glass can be scanned, as well, and can prevent the software from converting the document to editable text.

#### To clean the document feeder

---

 **WARNING!** Before cleaning the printer, turn the printer off by pressing  (**Power**), unplug the power cord from the electrical socket, and remove the battery (if installed).

---

1. Remove all originals from the document feeder tray.

- Lift the document feeder cover.



This provides easy access to the scan glass, rollers (1) and separator pad (2).

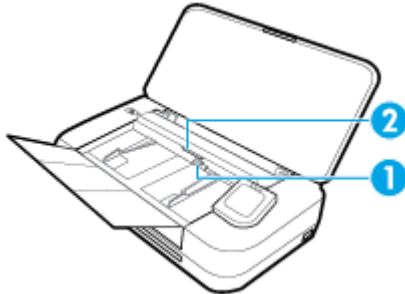

1	Rollers
2	Separator pad

- Lightly dampen a clean lint-free cloth with distilled water, then squeeze any excess liquid from the cloth.
  - Use the lint-free cloth to wipe any residue off the scan glass, rollers or separator pad.
-  **NOTE:** If the residue does not come off using distilled water, try using isopropyl (rubbing) alcohol.
- Close the cover of the document feeder.

## Maintain the cartridge and printer

If you are experiencing problems with printing, you might have a problem with the cartridge. You should perform the procedures in the following sections only when directed to do so for resolving print quality issues.

Performing the aligning and cleaning procedures unnecessarily can waste ink and shorten the life of the cartridges.

- Clean the cartridge if your printed output is streaked or has any incorrect or missing colors.

There are three stages of cleaning. Each stage lasts about two minutes, uses one sheet of paper, and uses an increasing amount of ink. After each stage, review the quality of the printed page. You should only initiate the next phase of cleaning if the print quality is poor.

If print quality still seems poor after you complete all stages of cleaning, try aligning the printer. If print quality problems persist after cleaning and aligning, contact HP support. For more information, see [HP support](#).

- Align the printer when the printer status page shows streaking or white lines through any of the blocks of color, or if you are having print quality issues with your printouts.

The printer automatically aligns the printer during the initial setup.



**NOTE:** Cleaning uses ink, so clean the cartridge only when necessary. The cleaning process takes a few minutes. Some noise might be generated in the process.

Always use the Power button to turn off the printer. Turning the printer off improperly can cause print quality problems.

### To clean cartridge or align printer

1. Load Letter or A4 unused plain white paper into the input tray. For more information, see [Load paper](#).
2. From the printer control panel, touch or swipe down the tab at the top of the screen to open the Dashboard, and then touch  ( **Setup** ).
3. Touch **Printer Maintenance** , select the desired option, and then follow the onscreen instructions.



**NOTE:** You can also do the same from the HP printer software or embedded web server (EWS). To access the software or EWS, see [Open the HP printer software \(Windows\)](#) or [Open the embedded web server](#).

## Restore original factory defaults and settings

If you disable some functions or change some settings and want to change them back, you can restore the printer to the original factory settings or network settings.

### To restore the printer to the original factory settings

1. From the printer control panel, touch or swipe down the tab at the top of the screen to open the Dashboard, and then touch  ( **Setup** ).
2. Touch **Printer Maintenance** .
3. Touch **Restore**.
4. Touch **Restore Settings**.
5. Select which function you would like to restore to the original factory settings:
  - Copy
  - Scan
  - Photo
  - Network
  - Web Services
  - Printer Setup

Touch **Restore**.

A message appears stating that the settings will be restored.

6. Touch **Yes**.

### To restore the printer to the original factory defaults

1. From the printer control panel, touch or swipe down the tab at the top of the screen to open the Dashboard, and then touch  ( **Setup** ).
2. Touch **Printer Maintenance** .



3. Touch **Restore**.
4. Touch **Restore Factory Defaults**.  
A message appears stating that the factory defaults will be restored.
5. Touch **Restore**.

#### To restore the printer to the original network settings

1. From the printer control panel, touch or swipe down the tab at the top of the screen to open the Dashboard, and then touch  (**Setup**).
2. Touch **Network Setup**.
3. Touch **Restore Network Settings**.  
A message appears stating that the network defaults will be restored.
4. Touch **Yes**.
5. Print the network configuration page and verify that the network settings have been reset.

 **NOTE:** When you reset the printer network settings, previously configured wireless settings (such as IP address) are removed. The IP address is set back to the Automatic mode.

 **TIP:**

- You can visit the HP online support website at [www.hp.com/support](http://www.hp.com/support) for information and utilities that can help you correct many common printer problems.
- (Windows) Run the [HP Print and Scan Doctor](#) to diagnose and automatically fix printing issues. The application is only available in some languages.

## HP support

For the latest product updates and support information, visit the printer support website at [www.hp.com/support](http://www.hp.com/support). HP online support provides a variety of options for help with your printer:



**Drivers & downloads:** Download software drivers and updates, as well as product manuals and documentation that came in the box with your printer.



**HP support forums:** Visit HP Support Forums for answers to common questions and issues. You can view questions posted by other HP customers, or sign in and post your own questions and comments.



**Troubleshooting:** Use HP online tools to detect your printer and find recommended solutions.

## Contact HP

If you need help from an HP technical support representative to solve a problem, visit the [Contact Support website](#). The following contact options are available at no cost for in-warranty customers (HP agent-assisted support for out-of-warranty customers may require a fee):



Chat with an HP support agent online.



Call an HP support agent.

---

When contacting HP support, be prepared to provide the following information:

- Product name (Located on the printer, such as HP OfficeJet 250 Mobile All-in-One)
- Product number (located near the cartridge access area)



- Serial number (located on the back or bottom of the printer)

## Register printer

By taking just a few quick minutes to register, you can enjoy quicker service, more efficient support, and product support alerts. If you did not register your printer while installing the software, you can register now at <http://www.register.hp.com>.

## Additional warranty options

Extended service plans are available for the printer at additional costs. Go to [www.hp.com/support](http://www.hp.com/support), select your country/region and language, then explore the extended warranty options available for your printer.

---

# A Technical information

This section contains the following topics:

- [Specifications](#)
- [Regulatory information](#)
- [Environmental product stewardship program](#)

## Specifications

For more information, visit [www.hp.com/support](http://www.hp.com/support). Select your country or region. Click **Product Support & Troubleshooting**. Enter the name shown on the front of the printer, and then select **Search**. Click **Product information**, and then click **Product specifications**.

### System requirements

- Software and system requirements can be found in the Readme file, which is available on the HP printer software CD provided with your printer.
- For information about future operating system releases and support, visit the HP online support website at [www.hp.com/support](http://www.hp.com/support).

### Environmental specifications

- Recommended operating temperature: 15°C to 30°C (59°F to 86°F)
- Allowable operating temperature: 5°C to 40°C (41°F to 104°F)
- Humidity: 15 to 95% RH (limited to a 31°C dew point temperature)
- Nonoperating (storage) temperature: -40°C to 60°C (-40°F to 140°F)

### Input tray capacity

- Plain paper sheets (64 to 100 g/m<sup>2</sup> [104 to 163 lb]): Up to 50
- Envelopes: Up to 5
- Index cards: Up to 20
- Hagaki paper sheets: Up to 20
- Photo paper sheets: Up to 15

### Paper size and weights

For the list of supported paper sizes, see the HP printer software.

- Plain paper: 64 g/m<sup>2</sup> and above (104 lb and above)
- Envelopes: 75 to 90 g/m<sup>2</sup> (20 to 24 lb)
- Cards: Up to 200 g/m<sup>2</sup> (110 lb index maximum)
- Photo paper: 300 g/m<sup>2</sup> (80 lb)

## Print specifications

- Print speeds vary according to the complexity of the document and printer model
- Method: drop-on-demand thermal officejet
- Language: PCL3
- Print resolution:  
For a list of supported print resolutions, visit the [www.hp.com/support](http://www.hp.com/support).
- Print margins:  
For margin settings for different medias, visit the [www.hp.com/support](http://www.hp.com/support).

## Scan specifications

- Color: 24-bit color
- Maximum scan size: 216 x 356 mm (8.5 x 14 inches)
- Minimum scan size: 76 x 12.7 mm (3 x 5 inches)

## Copy specifications

- Digital image processing
- Up to 50 copies from original
- Digital zoom: from 25 to 400%
- Copy speeds vary according to the selected copy quality

## Cartridge yield

- Visit [www.hp.com/go/learnaboutsupplies](http://www.hp.com/go/learnaboutsupplies) for more information on estimated cartridge yields.

# Regulatory information

The printer meets product requirements from regulatory agencies in your country/region.

This section contains the following topics:

- [Regulatory Model Number](#)
- [FCC statement](#)
- [VCCI \(Class B\) compliance statement for users in Japan](#)
- [Notice to users in Japan about the power cord](#)
- [Notice to users in Korea](#)
- [Noise emission statement for Germany](#)
- [European Union Regulatory Notice](#)
  - [Products with wireless functionality](#)
- [Visual display workplaces statement for Germany](#)
- [Declaration of conformity](#)
- [Regulatory information for wireless products](#)

- [Exposure to radio frequency radiation](#)
- [Notice to users in Canada](#)
- [Notice to users in Taiwan](#)
- [Notice to users in Japan](#)
- [Notice to users in Korea](#)

## Regulatory Model Number

For regulatory identification purposes, your product is assigned a Regulatory Model Number. The Regulatory Model Number for your product is SNPRC-1604-01. This regulatory number should not be confused with the marketing name (HP OfficeJet 250 Mobile All-in-One series or HP OfficeJet 258 Mobile All-in-One) or product number (CZ992A, N4L17A or L9D57A).

## FCC statement

### **FCC statement**

The United States Federal Communications Commission (in 47 CFR 15.105) has specified that the following notice be brought to the attention of users of this product.

This equipment has been tested and found to comply with the limits for a Class B digital device, pursuant to Part 15 of the FCC Rules. These limits are designed to provide reasonable protection against harmful interference in a residential installation. This equipment generates, uses and can radiate radio frequency energy and, if not installed and used in accordance with the instructions, may cause harmful interference to radio communications. However, there is no guarantee that interference will not occur in a particular installation. If this equipment does cause harmful interference to radio or television reception, which can be determined by turning the equipment off and on, the user is encouraged to try to correct the interference by one or more of the following measures:

- Reorient or relocate the receiving antenna.
- Increase the separation between the equipment and the receiver.
- Connect the equipment into an outlet on a circuit different from that to which the receiver is connected.
- Consult the dealer or an experienced radio/TV technician for help.

For further information, contact:

Manager of Corporate Product Regulations  
HP Inc. 1501 Page Mill Road,  
Palo Alto, CA 94304, U.S.A.

### **Modifications (part 15.21)**

The FCC requires the user to be notified that any changes or modifications made to this device that are not expressly approved by HP may void the user's authority to operate the equipment.

This device complies with Part 15 of the FCC Rules. Operation is subject to the following two conditions: (1) this device may not cause harmful interference, and (2) this device must accept any interference received, including interference that may cause undesired operation.

## VCCI (Class B) compliance statement for users in Japan

この装置は、クラスB情報技術装置です。この装置は、家庭環境で使用することを目的としていますが、この装置がラジオやテレビジョン受信機に近接して使用されると、受信障害を引き起こすことがあります。取扱説明書に従って正しい取り扱いをして下さい。

VCCI-B

## Notice to users in Japan about the power cord

製品には、同梱された電源コードをお使い下さい。  
同梱された電源コードは、他の製品では使用出来ません。

## Notice to users in Korea

B 급 기기 (가정용 방송통신기기)	이 기기는 가정용(B급)으로 전자파적합등록을 한 기기로서 주로 가정에서 사용하는 것을 목적으로 하며, 모든 지역에서 사용할 수 있습니다.
------------------------	--

## Noise emission statement for Germany

### Geräuschemission

LpA < 70 dB am Arbeitsplatz im Normalbetrieb nach DIN 45635 T. 19

## European Union Regulatory Notice



Products bearing the CE marking comply with one or more of the following EU Directives as may be applicable: Low Voltage Directive 2006/95/EC, EMC Directive 2004/108/EC, Ecodesign Directive 2009/125/EC, R&TTE Directive 1999/5/EC, RoHS Directive 2011/65/EU. Compliance with these directives is assessed using applicable European Harmonised Standards. The full Declaration of Conformity can be found at the following website: [www.hp.com/go/certificates](http://www.hp.com/go/certificates) (Search with the product model name or its Regulatory Model Number (RMN), which may be found on the regulatory label).

The point of contact for regulatory matters is:

HP Deutschland GmbH, HQ-TRE, Schickardstrasse 32, 71034 Boeblingen, Germany

## Products with wireless functionality

### EMF

- This product meets international guidelines (ICNIRP) for exposure to radio frequency radiation.

If it incorporates a radio transmitting and receiving device that in normal use, a separation distance of 20 cm ensures that radio frequency exposure levels comply with EU requirements.

#### Wireless functionality in Europe

- This product is designed for use without restrictions in all EU countries plus Iceland, Liechtenstein, Norway and Switzerland.

#### Visual display workplaces statement for Germany

##### **GS-Erklärung (Deutschland)**

Das Gerät ist nicht für die Benutzung im unmittelbaren Gesichtsfeld am Bildschirmarbeitsplatz vorgesehen. Um störende Reflexionen am Bildschirmarbeitsplatz zu vermeiden, darf dieses Produkt nicht im unmittelbaren Gesichtsfeld platziert werden.

# Declaration of conformity



## DECLARATION OF CONFORMITY according to ISO/IEC 17050-1 and EN 17050-1

DoC #: SNPRC-1604-01R3

**Supplier's Name:** Hewlett-Packard Company  
**Supplier's Address:** 138 Depot Road, #04-01, Singapore 109683

**declares, that the product**  
**Product Name and Model:** HP OfficeJet 250 Mobile AiO Printer  
HP OfficeJet 250C Mobile AiO Printer  
HP OfficeJet 252 Mobile AiO Printer  
HP OfficeJet 252C Mobile AiO Printer  
HP OfficeJet 258 Mobile AiO Printer

**Regulatory Model Number:** <sup>1)</sup> SNPRC-1604-01  
**Product Options:** All  
**Radio Module Number:** SDGOB-1503  
**Power Supply:** F0V63-60012 (World Wide) / F0V63-60013 (China and India Only)

**conforms to the following Product Specifications and Regulations:**

**EMC:**

CISPR 32:2012 / EN 55032:2012 Class B  
CISPR 24:2010 / EN 55024:2010  
EN 61000-3-2:2014  
EN 61000-3-3:2013  
FCC CFR 47, Part 15 Subpart B / ICES-003, Issue 5 Class B

**Safety:**

IEC 60950-1:2005 (2<sup>nd</sup> Edition) +A1:2009 +A2:2013  
EN 60950-1:2006 +A11:2009 +A1:2010 +A12:2011 +A2:2013  
EN 62479:2010  
CNS 14336:2004

**Telecom:**

EN 300 328 V1.8.1  
EN 301 489-1 V1.9.2  
EN 301 489-17 V2.2.1  
EN 62311:2008

**Energy Use:**

Regulation (EC) No. 1275/2008  
ENERGY STAR® Qualified Imaging Equipment Operational Mode (OM) Test Procedure  
EN 50564:2011  
IEC 62301:2011  
Regulation (EC) No. 278/2009  
Test Method for Calculating the Energy Efficiency of Single-Voltage External Ac-Dc and Ac-Ac Power Supplies

**RoHS:**

EN 50581:2012

The product herewith complies with the requirements of the Low Voltage Directive 2006/95/EC, the EMC Directive 2004/108/EC, the R&TTE Directive 1999/5/EC, the Ecodesign Directive 2009/125/EC, the RoHS Directive 2011/65/EU and carries the  marking accordingly.

This device complies with part 15 of the FCC Rules. Operation is subject to the following two conditions:

(1) This device may not cause harmful interference, and (2) this device must accept any interference received, including interference that may cause undesired operation.

**Additional Information:**

- 1) This product is assigned a Regulatory Model Number which stays with the regulatory aspects of the design. The Regulatory Model Number is the main product identifier in the regulatory documentation and test reports, this number should not be confused with the marketing name or the product numbers.
- 2) This product was tested in a typical HP configuration.

Singapore  
28 March 2016

Yik Hou Meng  
Product Regulations Manager  
HP Singapore Inkjet Printing Solutions

**Local contact for regulatory topics only:**

EU: HP Deutschland GmbH, HQ-TRE, Schickardstrasse 32, 71034 Boeblingen, Germany  
U.S.: HP Inc., 1501 Page Mill Road, Palo Alto, CA 94304, U.S.A. 650-857-1501

[www.hp.eu/certificates](http://www.hp.eu/certificates)



## Regulatory information for wireless products

This section contains the following regulatory information pertaining to wireless products:

- [Exposure to radio frequency radiation](#)
- [Notice to users in Canada](#)
- [Notice to users in Taiwan](#)
- [Notice to users in Japan](#)
- [Notice to users in Korea](#)

### Exposure to radio frequency radiation

#### Exposure to radio frequency radiation



**Caution** The radiated output power of this device is far below the FCC radio frequency exposure limits. Nevertheless, the device shall be used in such a manner that the potential for human contact during normal operation is minimized. This product and any attached external antenna, if supported, shall be placed in such a manner to minimize the potential for human contact during normal operation. In order to avoid the possibility of exceeding the FCC radio frequency exposure limits, human proximity to the antenna shall not be less than 20 cm (8 inches) during normal operation.

## Notice to users in Canada

### Notice to users in Canada/Note à l'attention des utilisateurs canadiens

Under Industry Canada regulations, this radio transmitter may only operate using an antenna of a type and maximum (or lesser) gain approved for the transmitter by Industry Canada. To reduce potential radio interference to other users, the antenna type and its gain should be so chosen that the equivalent isotropically radiated power (e.i.r.p.) is not more than that necessary for successful communication.

This device complies with Industry Canada licence-exempt RSS standard(s). Operation is subject to the following two conditions: (1) this device may not cause interference, and (2) this device must accept any interference, including interference that may cause undesired operation of the device.

**WARNING!** Exposure to Radio Frequency Radiation The radiated output power of this device is below the Industry Canada radio frequency exposure limits. Nevertheless, the device should be used in such a manner that the potential for human contact is minimized during normal operation.

To avoid the possibility of exceeding the Industry Canada radio frequency exposure limits, human proximity to the antennas should not be less than 20 cm (8 inches).

Conformément au Règlement d'Industrie Canada, cet émetteur radioélectrique ne peut fonctionner qu'avec une antenne d'un type et d'un gain maximum (ou moindre) approuvé par Industrie Canada. Afin de réduire le brouillage radioélectrique potentiel pour d'autres utilisateurs, le type d'antenne et son gain doivent être choisis de manière à ce que la puissance isotrope rayonnée équivalente (p.i.r.e.) ne dépasse pas celle nécessaire à une communication réussie.

Cet appareil est conforme aux normes RSS exemptes de licence d'Industrie Canada. Son fonctionnement dépend des deux conditions suivantes : (1) cet appareil ne doit pas provoquer d'interférences nuisibles et (2) doit accepter toutes interférences reçues, y compris des interférences pouvant provoquer un fonctionnement non souhaité de l'appareil.

**AVERTISSEMENT** relatif à l'exposition aux radiofréquences. La puissance de rayonnement de cet appareil se trouve sous les limites d'exposition de radiofréquences d'Industrie Canada. Néanmoins, cet appareil doit être utilisé de telle sorte qu'il soit mis en contact le moins possible avec le corps humain.

Afin d'éviter le dépassement éventuel des limites d'exposition aux radiofréquences d'Industrie Canada, il est recommandé de maintenir une distance de plus de 20 cm entre les antennes et l'utilisateur.

## Notice to users in Taiwan

### 低功率電波輻射性電機管理辦法

#### 第十二條

經型式認證合格之低功率射頻電機，非經許可，公司、商號或使用者均不得擅自變更頻率、加大功率或變更設計之特性及功能。

#### 第十四條

低功率射頻電機之使用不得影響飛航安全及干擾合法通信；經發現有干擾現象時，應立即停用，並改善至無干擾時方得繼續使用。

前項合法通信，指依電信法規定作業之無線電通信。低功率射頻電機須忍受合法通信或工業、科學及醫藥用電波輻射性電機設備之干擾。

## Notice to users in Japan

この機器は技術基準適合証明又は工事設計認証を受けた無線設備を搭載しています。

## Notice to users in Korea

해당 무선설비는 전파혼신 가능성이 있으므로 인명안전과 관련된 서비스는 할 수 없음

## Environmental product stewardship program

HP is committed to providing quality products in an environmentally sound manner. Design for recycling has been incorporated into this product. The number of materials has been kept to a minimum while ensuring proper functionality and reliability. Dissimilar materials have been designed to separate easily. Fasteners and other connections are easy to locate, access, and remove using common tools. High priority parts have been designed to access quickly for efficient disassembly and repair. For more information, visit HP's Commitment to the Environment website at:

[www.hp.com/hpinfo/globalcitizenship/environment](http://www.hp.com/hpinfo/globalcitizenship/environment)

- [Eco-Tips](#)
- [European Union Commission Regulation 1275/2008](#)
- [Paper](#)
- [Plastics](#)
- [Material safety data sheets](#)
- [Recycling program](#)
- [HP inkjet supplies recycling program](#)
- [Power consumption](#)
- [Disposal of waste equipment by users](#)
- [Chemical substances](#)
- [Restriction of hazardous substance \(Ukraine\)](#)
- [Restriction of hazardous substance \(India\)](#)
- [China SEPA Eco Label User Information](#)
- [China Energy Label for Printer, Fax and Copier](#)
- [The Table of Hazardous Substances/Elements and their Content \(China\)](#)
- [EPEAT](#)
- [Battery disposal in Taiwan](#)
- [EU Battery Directive](#)
- [California Rechargeable Battery Take-back Notice](#)
- [United States Call2Recycle \(RBRC\)](#)

## Eco-Tips

HP is committed to helping customers reduce their environmental footprint. Please visit the HP Environmental Programs and Initiatives website for more information on HP's environmental initiatives.

[www.hp.com/hpinfo/globalcitizenship/environment/](http://www.hp.com/hpinfo/globalcitizenship/environment/)

## European Union Commission Regulation 1275/2008

For product power data, including the power consumption of the product in networked standby if all wired network ports are connected and all wireless network ports are activated, please refer to section P14 'Additional Information' of the product IT ECO Declaration at [www.hp.com/hpinfo/globalcitizenship/environment/productdata/itecodesktop-pc.html](http://www.hp.com/hpinfo/globalcitizenship/environment/productdata/itecodesktop-pc.html).

## Paper

This product is suited for the use of recycled paper according to DIN 19309 and EN 12281:2002.

## Plastics

Plastic parts over 25 grams are marked according to international standards that enhance the ability to identify plastics for recycling purposes at the end of product life.

## Material safety data sheets

Material safety data sheets (MSDS) can be obtained from the HP website at:

[www.hp.com/go/msds](http://www.hp.com/go/msds).

## Recycling program

HP offers an increasing number of product return and recycling programs in many countries/regions, and partners with some of the largest electronic recycling centers throughout the world. HP conserves resources by reselling some of its most popular products.

For more information regarding recycling of HP products, please visit:

[www.hp.com/recycle](http://www.hp.com/recycle).

## HP inkjet supplies recycling program

HP is committed to protecting the environment. The HP Inkjet Supplies Recycling Program is available in many countries/regions, and lets you recycle used cartridges free of charge. For more information, go to the following website:

[www.hp.com/hpinfo/globalcitizenship/environment/recycle/](http://www.hp.com/hpinfo/globalcitizenship/environment/recycle/).

## Power consumption

HP printing and imaging equipment marked with the ENERGY STAR® logo is certified by the U.S. Environmental Protection Agency. The following mark will appear on ENERGY STAR certified imaging products:



Additional ENERGY STAR certified imaging product model information is listed at: [www.hp.com/go/energystar](http://www.hp.com/go/energystar).

## Disposal of waste equipment by users



This symbol means do not dispose of your product with your other household waste. Instead, you should protect human health and the environment by handing over your waste equipment to a designated collection point for the recycling of waste electrical and electronic equipment. For more information, please contact your household waste disposal service, or go to <http://www.hp.com/recycle>.

## Chemical substances

HP is committed to providing our customers with information about the chemical substances in our products as needed to comply with legal requirements such as REACH (*Regulation EC No 1907/2006 of the European Parliament and the Council*). A chemical information report for this product can be found at: [www.hp.com/go/reach](http://www.hp.com/go/reach).

## Restriction of hazardous substance (Ukraine)

### **Технічний регламент щодо обмеження використання небезпечних речовин (Україна)**

Обладнання відповідає вимогам Технічного регламенту щодо обмеження використання деяких небезпечних речовин в електричному та електронному обладнанні, затвердженого постановою Кабінету Міністрів України від 3 грудня 2008 № 1057

## Restriction of hazardous substance (India)

### **Restriction of hazardous substances (India)**

This product complies with the "India E-waste (Management and Handling) Rule 2011" and prohibits use of lead, mercury, hexavalent chromium, polybrominated biphenyls or polybrominated diphenyl ethers in concentrations exceeding 0.1 weight % and 0.01 weight % for cadmium, except for the exemptions set in Schedule 2 of the Rule.

## China SEPA Eco Label User Information

### **中国环境标识认证产品用户说明**

噪声大于63.0Db(A)的办公设备不宜放置于办公室内，请在独立的隔离区域使用。

如需长时间使用本产品或打印大量文件，请确保在通风良好的房间内使用。

如您需要确认本产品处于零能耗状态，请按下电源关闭按钮，并将插头从电源插座断开。

您可以使用再生纸，以减少资源耗费。

## 复印机、打印机和传真机能源效率标识 实施规则

依据“复印机、打印机和传真机能源效率标识实施规则”，该打印机具有中国能效标识。标识上显示的能效等级和操作模式值根据“复印机、打印机和传真机能效限定值及能效等级”标准（“GB 21521”）来确定和计算。

### 1. 能效等级

产品能效等级分为3级，其中1级能效最高。能效限定值根据产品类型和打印速度由标准确定。能效等级则根据基本功耗水平以及网络接口和内存等附加组件和功能的功率因子之和来计算。

### 2. 能效信息

#### 喷墨打印机

- 操作模式功率

睡眠状态的能耗按照 GB 21521 标准来衡量和计算。该数据以瓦特 (W) 表示。

- 待机功率

待机状态是产品连接到电网电源上功率最低的状态。该状态可以延续无限长时间，且使用者无法改变此状态下产品的功率。对于“成像设备”产品，“待机”状态通常相当于“关闭”状态，但也可能相当于“准备”状态或“睡眠”状态。该数据以瓦特 (W) 表示。

- 睡眠状态预设延迟时间

出厂前由制造商设置的时间决定了该产品在完成主功能后进入低耗模式（例如睡眠、自动关机）的时间。该数据以分钟表示。

- 附加功能功率因子之和

网络接口和内存等附加功能的功率因子之和。该数据以瓦特 (W) 表示。

标识上显示的能耗数据是根据典型配置测量得出的数据，此类配置包含登记备案的打印机依据复印机、打印机和传真机能源效率标识实施规则所选的所有配置。因此，该特定产品型号的实际能耗可能与标识上显示的数据有所不同。

要了解规范的更多详情，请参考最新版的 GB 21521 标准。

## The Table of Hazardous Substances/Elements and their Content (China)

**产品中有有害物质或元素的名称及含量**  
根据中国《电器电子产品有害物质限制使用管理办法》

部件名称	有害物质					
	铅 (Pb)	汞 (Hg)	镉 (Cd)	六价铬 (Cr(VI))	多溴联苯 (PBB)	多溴二苯醚 (PBDE)
外壳和托盘	0	0	0	0	0	0
电线	0	0	0	0	0	0
印刷电路板	X	0	0	0	0	0
打印系统	X	0	0	0	0	0
显示器	X	0	0	0	0	0
喷墨打印机墨盒	0	0	0	0	0	0
驱动光盘	X	0	0	0	0	0
扫描仪	X	0	0	0	0	0
网络配件	X	0	0	0	0	0
电池板	X	0	0	0	0	0
自动双面打印系统	0	0	0	0	0	0
外部电源	X	0	0	0	0	0

本表格依据SJ/T 11364 的规定编制。  
 0: 表示该有害物质在该部件所有均质材料中的含量均在GB/T 26572 规定的限量要求以下。  
 X: 表示该有害物质至少在该部件的某一均质材料中的含量超出GB/T 26572 规定的限量要求。

此表中所有名称中含“X”的部件均符合欧盟 RoHS 立法。

注: 环保使用期限的参考标识取决于产品正常工作的温度和湿度等条件。



## EPEAT

### EPEAT

Most HP products are designed to meet EPEAT. EPEAT is a comprehensive environmental rating that helps identify greener electronics equipment. For more information on EPEAT go to [www.epeat.net](http://www.epeat.net). For information on HP's EPEAT registered products go to [www.hp.com/hpinfo/globalcitizenship/environment/pdf/epeat\\_printers.pdf](http://www.hp.com/hpinfo/globalcitizenship/environment/pdf/epeat_printers.pdf).

## Battery disposal in Taiwan



廢電池請回收

# EU Battery Directive



English	<p><b>European Union Battery Directive</b> This product contains a battery that is used to maintain data integrity of real time clock or product settings and is designed to last the life of the product. Any attempt to service or replace this battery should be performed by a qualified service technician.</p>
Français	<p><b>Directive sur les batteries de l'Union Européenne</b> Ce produit contient une batterie qui permet de maintenir l'intégrité des données pour les paramètres du produit ou l'horloge en temps réel et qui a été conçue pour durer aussi longtemps que le produit. Toute tentative de réparation ou de remplacement de cette batterie doit être effectuée par un technicien qualifié.</p>
Deutsch	<p><b>Batterie-Richtlinie der Europäischen Union</b> Dieses Produkt enthält eine Batterie, die dazu dient, die Datenintegrität der Echtzeituhr sowie der Produkteinstellungen zu erhalten, und die für die Lebensdauer des Produkts ausreicht. Im Bedarfsfall sollte das Instandhalten bzw. Austauschen der Batterie von einem qualifizierten Servicetechniker durchgeführt werden.</p>
Italiano	<p><b>Direttiva dell'Unione Europea relativa alla raccolta, al trattamento e allo smaltimento di batterie e accumulatori</b> Questo prodotto contiene una batteria utilizzata per preservare l'integrità dei dati dell'orologio in tempo reale o delle impostazioni del prodotto e la sua durata si intende pari a quella del prodotto. Eventuali interventi di riparazione o sostituzione della batteria devono essere eseguiti da un tecnico dell'assistenza qualificato.</p>
Español	<p><b>Directiva sobre baterías de la Unión Europea</b> Este producto contiene una batería que se utiliza para conservar la integridad de los datos del reloj de tiempo real o la configuración del producto y está diseñada para durar toda la vida útil del producto. El mantenimiento o la sustitución de dicha batería deberá realizarla un técnico de mantenimiento cualificado.</p>
Čeština	<p><b>Směrnice Evropské unie pro nakládání s bateriemi</b> Tento výrobek obsahuje baterii, která slouží k uchování správných dat hodin reálného času nebo nastavení výrobku. Baterie je navržena tak, aby vydržela celou životnost výrobku. Jakýkoliv pokus o opravu nebo výměnu baterie by měl provést kvalifikovaný servisní technik.</p>
Dansk	<p><b>EU's batteridirektiv</b> Produktet indeholder et batteri, som bruges til at vedligeholde dataintegriteten for realtidsur- eller produktindstillinger og er beregnet til at holde i hele produktets levetid. Service på batteriet eller udskiftning bør foretages af en uddannet servicetekniker.</p>
Nederlands	<p><b>Richtlijn batterijen voor de Europese Unie</b> Dit product bevat een batterij die wordt gebruikt voor een juiste tijdsaanduiding van de klok en het behoud van de productinstellingen. Bovendien is deze ontworpen om gedurende de levensduur van het product mee te gaan. Het onderhoud of de vervanging van deze batterij moet door een gekwalificeerde onderhoudstechnicus worden uitgevoerd.</p>
Eesti	<p><b>Euroopa Liidu aku direktiiv</b> Toode sisaldab akku, mida kasutatakse reaalaja kella andmeühitsuse või toote säilimiseseadme jaoks. Aku on valmistatud kestma terve toote kasutusaja. Akut tohib hooldada või vahetada ainult kvalifitseeritud hooldustehnik.</p>
Suomi	<p><b>Euroopan unionin paristodirektiivi</b> Tämä laite sisältää pariston, jota käytetään reaaliaikaisen kellon tietojen ja laitteen asetusten säilyttämiseen. Pariston on suunniteltu kestävän laitteen koko käyttöajan ajan. Pariston maallinen korjaus tai vaihto on jätettävä pätevän huoltohenkilön tehtäväksi.</p>
Ελληνικά	<p><b>Οδηγία της Ευρωπαϊκής Ένωσης για τις ηλεκτρικές στήλες</b> Αυτό το προϊόν περιλαμβάνει μια μπαταρία, η οποία χρησιμοποιείται για τη διατήρηση της ακεραιότητας των δεδομένων ρολογιού πραγματικού χρόνου ή των ρυθμίσεων προϊόντος και έχει σχεδιαστεί έτσι ώστε να διαρκέσει όσο και το προϊόν. Τυχόν απόπειρες επιδιόρθωσης ή αντικατάστασης αυτής της μπαταρίας θα πρέπει να πραγματοποιούνται από κατάλληλα εκπαιδευμένο τεχνικό.</p>
Magyar	<p><b>Az Európai unió telepek és akkumulátorok direktívája</b> A termék tartalmaz egy elemet, melynek feladata az, hogy biztosítsa a valós időjárás vagy a termék beállításainak adatintegritását. Az elem úgy van tervezve, hogy végig kitartsa a termék használatá során. Az elem bármilyen javítását vagy cseréjét csak képzett szakember végezheti el.</p>
Lietuvių	<p><b>Europos Sąjunga baterijų direktiva</b> Produktas turi bateriją, kuri naudojama realiu laiku laikrodžio veikimo arba gaminio nuostatos, ir ją pakeičiant išlaikyti produkto duomenų integritatę. Baterija yra sukurta taip, kad išlaikytų visą produkto naudojimo laiką. Betkoks šios baterijos aptarnavimo arba keitimo darbas turi atlikti kvalifikuotas aptarnavimo technikas.</p>
Lietuvių kalba	<p><b>Europos Sąjungos baterijų ir akumuliatorių direktyva</b> Šiame gaminyje yra baterija, kuri naudojama, kad būtų galima prižiūrėti realaus laiko laikrodžio veikimą arba gaminio nuostatas; ji skirta veikti visą gaminio eksploatavimo laiką. Betkokius šios baterijos aptarnavimo arba keitimo darbus turi atlikti kvalifikuotas aptarnavimo technikas.</p>
Polski	<p><b>Dyrektywa Unii Europejskiej w sprawie baterii i akumulatorów</b> Produkt zawiera baterię wykorzystywaną do zachowania integralności danych zegara czasu rzeczywistego lub ustawień produktu, która podtrzyma działanie produktu. Przejąd lub wymiana baterii powinny być wykonywane wyłącznie przez uprawnionego technika serwisu.</p>
Português	<p><b>Directiva sobre baterias da União Europeia</b> Este produto contém uma bateria que é usada para manter a integridade dos dados do relógio em tempo real ou das configurações do produto e é projetada para ter a mesma duração que este. Qualquer tentativa de consertar ou substituir essa bateria deve ser realizada por um técnico qualificado.</p>
Slovenčina	<p><b>Smernica Evropske unije pre zaobchádzanie s batériami</b> Tento výrobok obsahuje batériu, ktorá slúži na uchovenie správnych údajov hodín reálneho času alebo nastavení výrobku. Batéria je skonštruovaná tak, aby vydržala celú životnosť výrobku. Akýkoľvek pokus o opravu alebo výmenu batérie by mal vykonať kvalifikovaný servisný technik.</p>
Slovenščina	<p><b>Direktiva Evropske unije o baterijah in akumulatorjih</b> V tem izdelku je baterija, ki zagotavlja natančnost podatkov ure v realnem času ali nastavitve izdelka v realni življenjski dobi izdelka. Kakršnokoli popravilo ali zamenjava te baterije lahko izvede le pooblaščen tehnik.</p>
Svenska	<p><b>EU:s batteridirektiv</b> Produkten innehåller ett batteri som används för att upprätthålla data i realtidsklockan och produktinställningarna. Batteriet ska räkna produktens hela livslängd. Endast kvalificerade servicetekniker får utföra service på batteriet och byta ut det.</p>
Български	<p><b>Директива за батерии на Европейския съюз</b> Този продукт съдържа батерия, която се използва за поддържане на целостта на данните на часовника в реално време или настройките за продукта, създадена на издръжливост през целия живот на продукта. Сервизът или замяната на батерията трябва да се извършва от квалифициран техник.</p>
Română	<p><b>Directiva Uniunii Europene referitoare la baterii</b> Acest produs conține o baterie care este utilizată pentru a menține integritatea datelor ceasului de timp real sau setările produsului și care este proiectată să funcționeze pe întreaga durată de viață a produsului. Orice lucrare de service sau de înlocuire a acestei baterii trebuie efectuată de un tehnician de service calificat.</p>



## California Rechargeable Battery Take-back Notice

HP encourages customers to recycle used electronic hardware, HP original cartridges, and rechargeable batteries. For more information about recycling programs, go to [www.hp.com/recycle](http://www.hp.com/recycle).

## United States Call2Recycle (RBRC)



# Index

## A

accessibility 2  
align printer 76

## B

both sides, print on 28  
buttons, control panel 8

## C

cartridge access door, locating 7  
cartridges 49  
    check ink levels 46  
    locating 7  
    replace 47  
    tips 46  
clean  
    cartridge 76  
    document feeder 75  
    exterior 75  
    printer 77  
colored text, and OCR 38  
connectors, locating 7  
control panel  
    buttons 8  
    lights 8  
    status icons 9  
customer support  
    warranty 79

## D

diagnostic page 74  
document feeder  
    clean 75  
    feeding problems, troubleshoot 75  
    load originals 16  
double-sided printing 28

## E

edit  
    text in OCR program 38  
embedded web server  
    about 57

    opening 58  
    troubleshoot, cannot be opened 59  
environmental specifications 80  
environmental sustainability program 88  
EWS. *See* embedded web server

## H

HP Utility (OS X)  
    opening 57  
humidity specifications 80

## I

ink level icons 9  
ink levels, check 46  
IP address  
    checking for printer 59  
IP settings 53

## J

jams  
    clear 60  
    paper to avoid 13

## L

lights, control panel 8

## M

Mac OS 23  
maintain  
    cartridge 76  
    page smear 76  
maintenance  
    align printer 76  
    cartridge 76  
    check ink levels 46  
    clean 75  
    clean cartridge 77  
    diagnostic page 74  
    replace cartridges 47  
margins  
    setting, specifications 81  
multi-feeds, troubleshoot 63

## N

networks  
    connector illustration 7  
    IP settings 53  
    settings, change 52  
    wireless communication setup 50  
    wireless settings 74

## O

OCR  
    edit scanned documents 38  
operating systems supported 80  
OS X  
    HP Utility 57  
output tray  
    locating 5

## P

paper  
    clear jams 60  
    HP, order 13  
    load tray 14  
    selecting 13  
    skewed pages 63  
    specifications 80  
    troubleshoot feeding 63  
paper-feed problems, troubleshoot 63  
power  
    troubleshoot 73  
power input, locating 7  
print  
    diagnostic page 74  
    double-sided 28  
    manually 28  
    troubleshoot 73  
Print brochures  
    print 23  
print quality  
    clean page smear 76  
print quality report 74  
printer 76  
    clean 77

- printer control panel
  - locating 5
  - network settings 52
- printer software (Windows)
  - about 57
  - opening 21, 57
- printer status report
  - information on 74
- printer, align 76

**R**

- radio interference
  - regulatory information 86
- rear access panel
  - illustration 7
- recycle
  - cartridges 89
- regulatory information 81, 86
- regulatory model number 82
- replace cartridges 47
- reports
  - diagnostic 74

**S**

- scan
  - OCR 38
- send scans
  - for OCR 38
- settings
  - network 52
- Setup icon 9
- skew, troubleshoot
  - print 63
- software
  - OCR 38
- specifications
  - paper 80
  - physical 80
  - system requirements 80
- status
  - network configuration page 74
- status icons 9
- system requirements 80

**T**

- temperature specifications 80
- trays
  - clear paper jams 60
  - load paper 14
  - locating 5

- paper-width guides illustration 5
- troubleshoot feeding 63

troubleshoot

- control panel help system 73
- embedded web server 59
- multiple pages are picked 63
- network configuration page 74
- paper not picked up from tray 63
- paper-feed problems 63
- power 73
- print 73
- printer status report 74
- skewed pages 63

two-sided printing 28

**U**

- USB connection
  - port, locating 5, 7

**W**

- warranty 79
- websites
  - accessibility information 2
  - environmental programs 88
- Windows
  - print brochures 22, 23
  - system requirements 80
- wireless communication
  - regulatory information 86
  - set up 50
- wireless connection icons 9

