

CyberPower[®]
Reliability. Quality. Value.

User's Manual

**Professional Rack Mount LCD Series
PR750ELCDRT1U/PR1000ELCDRT1U**

IMPORTANT SAFETY INSTRUCTIONS

This manual contains important instructions. Please read and follow all instructions carefully during installation and operation of the unit. Read this manual thoroughly before attempting to unpack, install, or operate the UPS.

CAUTION! The UPS must be connected to a grounded AC power outlet with fuse or circuit breaker protection. DO NOT plug the UPS into an outlet that is not grounded. If you need to power-drain this equipment, turn it off and unplug the unit.

CAUTION! The battery can power hazardous components inside the unit, even when the AC input power is disconnected.

CAUTION! The UPS should be near the connected equipment and easily accessible.

CAUTION! To prevent the risk of fire or electric shock, install in a temperature and humidity controlled indoor area, free of conductive contaminants. (Please see specifications for acceptable temperature and humidity range).

CAUTION! To reduce the risk of an electric shock, do not remove the cover, except to service the battery. There are no user serviceable parts inside, except for the battery.

CAUTION! To avoid electrical shock, turn off the unit and unplug it from the AC power source before servicing the battery or installing a computer component.

CAUTION! To reduce the risk of fire, connect the UPS to a circuit with 10 Amps maximum over-current protection in accordance to CE requirements.

CAUTION! The AC outlet where the UPS is connected should be close to the unit and easily accessible.

CAUTION! Please use only VDE-tested, CE-marked mains cable, (e.g. the mains cable of your equipment), to connect the UPS to the AC outlet.

CAUTION! Please use only VDE-tested, CE-marked power cables to connect any equipment to the UPS.

CAUTION! When installing the equipment, ensure that the sum of the leakage current of the UPS and the connected equipment does not exceed 3.5mA.

CAUTION! This is permanently connected equipment and only qualified maintenance personnel may carry out installations.

CAUTION! Do not unplug the unit from AC Power during operation, as this will invalidate the protective ground insulation.

CAUTION! DO NOT USE FOR MEDICAL OR LIFE SUPPORT EQUIPMENT! Under no circumstances this unit should be used for medical applications involving life support equipment and/or patient care.

CAUTION! DO NOT USE WITH OR NEAR AQUARIUMS! To reduce the risk of fire, do not use with or near aquariums. Condensation from the aquarium can come in contact with metal electrical contacts and cause the machine to short circuit.

CAUTION! DO NOT USE WITH LASER PRINTERS! The power demands of laser printers are too large for this unit.

DO NOT INSTALL THE UPS WHERE IT WOULD BE EXPOSED TO DIRECT SUNLIGHT OR NEAR A STRONG HEAT SOURCE!

DO NOT BLOCK OFF VENTILATION OPENINGS AROUND THE HOUSING!

DO NOT CONNECT DOMESTIC APPLIANCES SUCH AS HAIR DRYERS TO UPS OUTPUT SOCKETS.

INSTALLING YOUR UPS SYSTEM

UNPACKING

The box should contain the following:

(1) UPS unit x 1; (2) User manual x 1; (3) Phone line x 1; (4) PowerPanel® Business Edition software CD x 1; (5) USB A+B type cable x 1; (6) Rack mount Brackets x 2; (7) Emergency Power-Off Cable (gray) x 1; (8) Serial Interface Cable (DB-9) x 1; (9) Power Cord x 4

AUTOMATIC VOLTAGE REGULATOR(AVR)

The PR750ELCDRT1U/ PR1000ELCDRT1U can stabilise utility power inconsistencies. The utility power may be damaging to important data and hardware, but Automatic Voltage Regulation helps the computer not experience dangerous voltage levels. The Automatic Voltage Regulator regulates low or high voltages to keep equipment working at safe AC power levels, (220/230/240V), without switching to battery mode. Your equipment can operate normally even during power problems, such as, short brownouts and blackouts. The unit's powerful sealed lead-acid batteries will provide power only if the incoming voltage drops below 150V or increases above 300V.

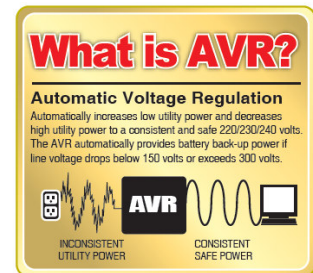

SYSTEM BLOCK DIAGRAM

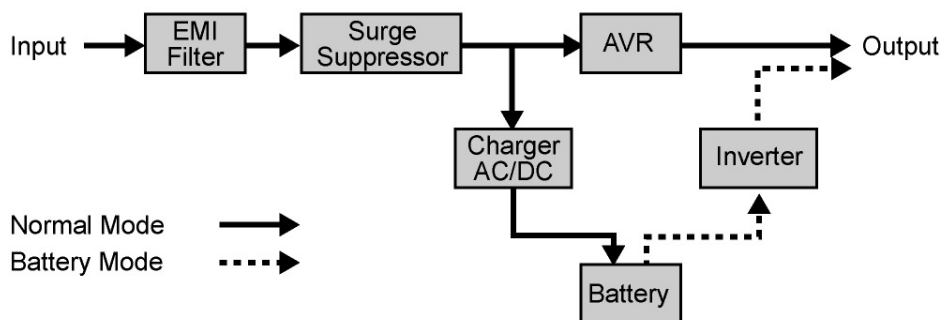

HARDWARE INSTALLATION GUIDE

1. Battery charge loss may occur during shipping and storage. For the first time the UPS is used, it is strongly recommended to charge batteries for at least four hours in order to ensure maximum capacity. To do so, simply plug the unit into an AC outlet.
2. When you use the included software, connect either the serial or the USB cable between the computer and the corresponding port on the UPS. **Note:** If the USB port is used, the serial port will be disabled. They cannot be used simultaneously. The computer with the PowerPanel® Business Edition S/W connects to the USB port or to the serial port on the UPS. It can control the operating schedule, battery test, outlet, etc. and get information on the UPS status. However, other computers with PowerPanel® Business Edition S/W can only get UPS status information via a LAN connection.
3. With the UPS unit off and unplugged, connect your computer, monitor, and any externally powered data storage device, (Hard drive, Tape drive, etc.) onto the outlets. DO NOT plug a laser printer, copier, space heater, vacuum cleaner, paper shredder or other large electrical device into the UPS. The power demands of these devices will overload and possibly damage the unit.
4. To protect a fax, telephone, modem line or network cable, connect the telephone or network cable from the wall jack outlet to the jack marked "IN" on the UPS. Then, connect a telephone or network cable from the jack marked "OUT" on the UPS to the modem, computer, telephone, fax machine, or network device.

INSTALLING YOUR UPS SYSTEM (continued)

5. Press the power switch to turn the UPS on. The Power-On indicator light will illuminate. If an overload is detected, an audible alarm will sound and the UPS will emit one long beep. In order to reset it, turn the unit off and unplug some equipment from outlets. Make sure your equipment carry a load current within the unit's safety range, (refer to the technical specifications), and then turn the unit on.
6. Your UPS is equipped with an auto-charge feature. When the UPS is plugged into an AC outlet, the battery will be automatically charging, even when the unit is switched off!
7. To always maintain an optimal battery charge, leave the UPS plugged into an AC outlet at all times.
8. Before storing the UPS for an extended period of time, turn the unit OFF. Then cover it and store it with the batteries fully charged. Recharge the batteries every three months or so, to ensure good battery capacity and long battery life; further, this might also prevent damage to the unit from an unlikely battery leakage.
9. The unit provides one serial port and one USB port to allow connection and communications between the UPS and any attached computer. The primary computer, (the one with PowerPanel® Business Edition S/W installed), is the computer that you will use to control the UPS and make any changes to its operation. When there is a power failure, the connected to the USB or Serial Port computer may be "asked" by the UPS for a graceful shutdown following a possible pre-programmed time period delay indicated within the controlled S/W.
10. EPO (*Emergency Power Off*) Port:
Use the provided gray cable to connect to a special EPO contact switch. Follow the appropriate circuit diagram below to wire the cable to your EPO configuration. The EPO remote switch is a switch installed in an outside area, connected to the unit via an ordinary RJ-11 phone line. In case of an emergency, it can be used to immediately cut-off power from the UPS unit.

BASIC OPERATION

FRONT PANEL DESCRIPTION

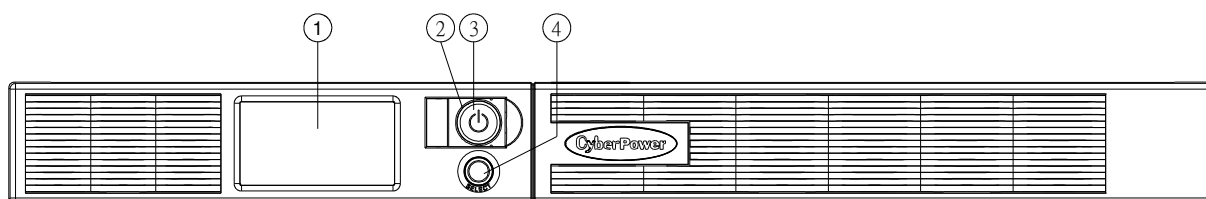

1. Multifunction LCD Readout

An LCD that shows various UPS information using icons and messages.

2. Power On Indicator

Indicates that the AC utility input power's condition is normal and that the UPS outlets are providing power, free of surges and spikes.

3. Power Switch

Master on/off switch for equipment connected to the UPS.

4. LCD Readout Toggle Button

Used to select among a variety of information the LCD can display.

BASIC OPERATION (continued)

REAR PANEL DESCRIPTION

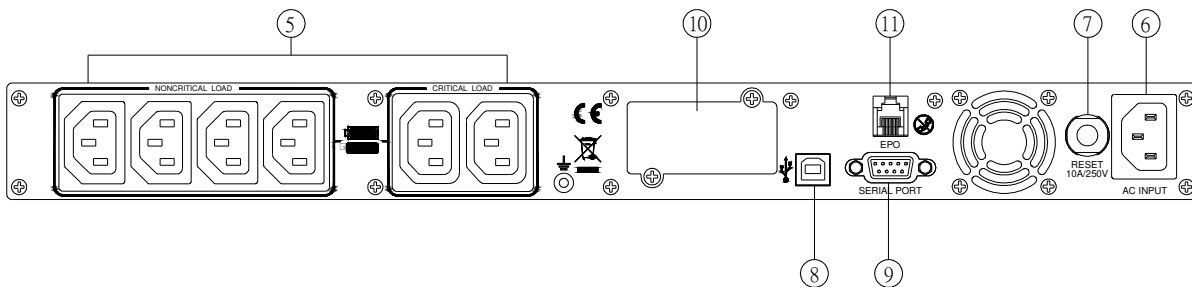

5. Battery Backup and Surge Protected Outlets

The unit provides a total of six outlets with battery backup and surge protection. They ensure that connected equipment will keep an uninterrupted operation over a period of time, during a power failure.

Critical /Non-critical

It is possible to program the unit in a way so that the outlet block marked as “non-Critical”, (4 ports), will stop the provision of power to connected equipment after a certain period of time, thus making more runtime available for the equipment connected on the outlets marked as “Critical”, (2 ports). In other words, the user can establish runtime priority for certain connected equipment, maximizing its “availability” during a prolonged power outage. This type of control takes place with the use of the provided PowerPanel® Business Edition S/W.

6. AC Inlet

Connect the AC Power cord to a properly wired and grounded outlet.

7. Input Circuit Breaker

This circuit breaker serves to provide input overload and fault protection.

8. USB port to PC

This is a connectivity port allowing communication and control among the UPS and the connected computer. You should install on your computer the PowerPanel® Business Edition software appropriate to the operating system you are using.

9. Serial Port

This is a connectivity port allowing communication and control among the UPS and the connected computer. You should install on your computer the PowerPanel® Business Edition software appropriate to the operating system you are using.

10. SNMP/HTTP Network slot

Remove the cover panel to install an optional SNMP, allowing your UPS be controlled and monitored via a network connection.

11. EPO (Emergency Power Off) port

Allow for an emergency UPS Power-Off from a remote location.

BATTERY REPLACEMENT

Allow for an emergency UPS Power-Off from a remote location. Read and follow the IMPORTANT SAFETY INSTRUCTIONS before servicing the batteries:

Servicing the batteries should only be performed by professionals. For further information please contact your dealer, or email to: service@cyberpower-eu.com. Make a note for the replacement battery pack number, (RBP422), regarding PR750ELCDRT1U and PR1000ELCDRT1U models.

BATTERY REPLACEMENT (continued)

CAUTION! Use only the specified type of battery: **HR9-6(BB)** for **PR750ELCDRT1U/ PR1000ELCDRT1U**. Contact your dealer for replacement batteries.

CAUTION! The battery may represent the risk of electrical shock. Do not dispose of batteries on fire, since they may explode. Follow all local ordinances regarding the proper disposal of batteries.

CAUTION! Do not open or mutilate the batteries. Released electrolyte is harmful to the skin and eyes and may be toxic.

CAUTION! A battery can present a high risk for short-circuits and electrical shocks.

Take the following precautions before replacing the battery:

1. Remove all watches, rings or other metal objects from your hands.
2. Only use tools with insulated handles.
3. DO NOT lay tools or other metal parts on top of the battery or any battery terminals.
4. Wear rubber gloves and shoes.
5. Determine if the battery is grounded. If so, remove ground source. **CAUTION: CONTACT WITH A GROUNDED BATTERY CAN RESULT IN ELECTRICAL SHOCK!** The likelihood of such a shock will be greatly reduced if such grounding is removed during installation and maintenance.

BATTERY REPLACEMENT PROCEDURE:

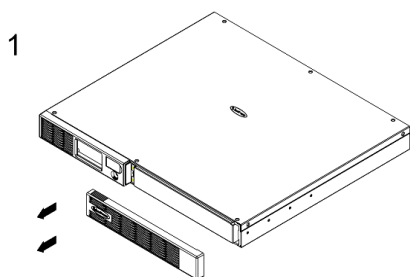

Remove the front panel on the right side.

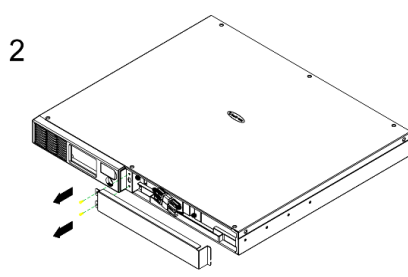

Remove the two retaining screws of the cable protection cover, and then remove the cover itself.

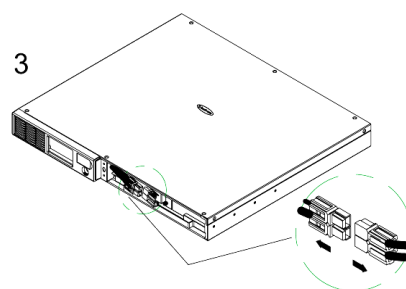

Disconnect the black and red wires from the battery.

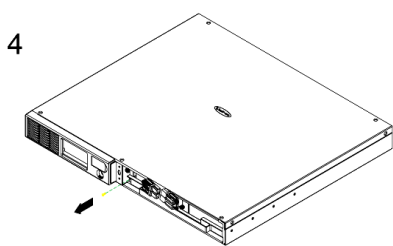

Remove the retaining screw.

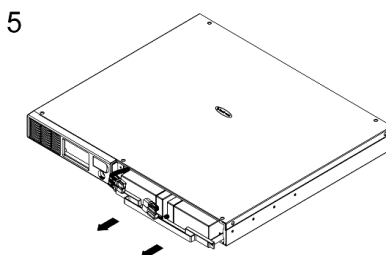

Put the new battery packs back into the compartment. Tighten up the screws and replace the cable protection cover and the front panel. Recharge the unit for at least 8 hours to ensure that the UPS performs to the expected runtimes.

REMINDER! The used batteries are hazardous wastes and must be disposed through recycling. Most retailers that sell lead-acid batteries collect used batteries for recycling, as required by the local regulations.



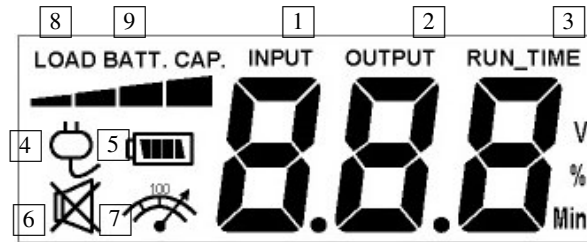

DEFINITIONS FOR ILLUMINATED LCD INDICATORS







- 1. Input voltage meter:** This meter measures the AC voltage from the wall outlet. The INPUT voltage readout is used to identify the input voltage information. When the UPS connects to any equipment, the AVR can provide a stable 220/230/240V power output. In the event of a complete loss of power, severe brownout, or over voltage, the UPS relies on its internal battery to back up to supply a consistent 220/230/240V output.
- 2. Output voltage meter:** This meter measures the output voltage from the UPS.
- 3. Estimated Run Time:** This displays the estimated UPS runtime based on current load. When runtime becomes shorted, the battery capacity will decrease; (battery capacity bar indicator will be falling).
- 4. Normal mode icon:** This icon illuminates when the UPS is working under normal conditions.
- 5. Battery icon:** When there is a severe brownout or blackout, this icon will appear followed by an alarm, (two short beeps), indicating that the UPS is now working using its internal batteries. Once the batteries are run out of power, (over a period of time), a constant alarm will sound. If this happens and main power has not been restored, it is recommended that you save your files and turn off your equipment manually as soon as possible.
- 6. Silent mode icon:** This icon appearing indicates that the buzzer will not be beeping while in battery operating mode. During Silent mode, the unit's alarm does not sound until the Battery Capacity falls to < 20%.
- 7. Over load icon:** This icon will appear followed by an alarm, indicating that an overload condition has been reached. To recover from the overload condition, start unplugging your equipment from the UPS outlets until the icon disappears and the alarm stops.
- 8. BATT. CAPACITY:** BATT. CAPACITY is shown as a bar chart; each segment indicates approximately a 20% of battery capacity.
- 9. LOAD CAPACITY:** Load CAPACITY is shown as a bar chart; each segment indicates approximately a 20% of load capacity.

DEFINITIONS FOR ILLUMINATED LCD INDICATORS (continued)

Line mode

Select SW Press	UPS Status Display				Capacity Display			Digital Value Display			
					Load Cap	Battery Cap	Input Voltage	Output Voltage	Run Time	% of Load	% of Battery
Initial	V	X	--	X		V	V				
1 st	V	X	--	X		V		V			
2 nd	V	X	--	X	V					V	
3 rd	V	X	--	X		V		V			
4 th	V	X	--	X				V			
5 th (return)	V	X	--	X		V	V				
Press>4sec (Self test)	X	V	V	X	--	--	--	--	--	--	--
(overload)	V	X	--	V	--	--	--	--	--	V	--

Battery Mode

Select SW Press	UPS Status Display				Capacity Display			Digital Value Display			
					Load Cap	Battery Cap	Input Voltage	Output Voltage	Run Time	% of Load	% of Battery
Initial	X	V	--	X		V	V				
1 st	X	V	--	X		V		V			
2 nd	X	V	--	X	V					V	
3 rd	X	V	--	X		V					V
4 th	X	V	--	X					V		
5 th (return)	X	V	--	X		V	V				
Press>4sec (sound disable)	X	V	V	X	--	--	--	--	--	--	--
Press>4sec again(sound enable)	X	V	X	X	--	--	--	--	--	--	--
overload	X	V	--	V	--	--	--	--	--	V	--

"V" illuminated, "X" Not illuminated, "--" either

LCD SETUP FUNCTIONS

General Mode

- a. Press the “Display-Toggle” button to check the UPS status:

Items	Unit
Input Voltage	V
Output Voltage	V
Load Capacity	%
Battery Capacity	%

- b. Press and hold the Display-toggle button for 4 seconds:
 If the machine is in the Battery Mode with active alarm, it will become silent.
 If the machine is in the Line Mode, a self- diagnostic test will take place.
- c. If the Display-toggle button remains untouched for over 30 seconds, the LCD backlight will turn off automatically.

Set-up Mode

Step 1: Hold the Display-toggle button for 10 seconds to enter the UPS Set-Up Mode.

Step 2: By pressing the Display toggle, users can switch between setup functions. Some User Configurable functions are as follows:

- a. Delay Time: The time delay between switching from Battery Mode to Line Mode. There are 9 different settings. The default setting is 0 minutes.
- b. Battery Pack Numbers: PR750ELCDRT1U/ PR1000ELCDRT1U do not support this function, and the LCD always shows 0.
- c. Static Frequency Tolerance: There are 6 settings (1,2,4,6,8,10 %), and the default setting is +/- 6%.
 Functional description: The setting may be adjusted to the quality of the electricity in use.
- d. Slew Rate: Also known as *Dynamic Frequency Tolerance*. There are 5 different settings (0.25,0.5,1,2,4 Hz/Sec). The fault value is 4Hz/sec. **Functional Description:** “*Slew Rate*” indicates the tolerance of a device in accepting frequency variance. Lower “Slew Rate” results in less tolerance but better protection for the connected load and vice versa.
- e. Low Battery Shutdown Voltage: This function will adjust the UPS shutdown point according to the battery’s remaining capacity.

These programmable items are sorted by unit as in the following table :

Items	Unit
Delay Time	Min
Battery Pack Numbers	None
Static Frequency Tolerance	%
Slew Rate	%
Low Battery Shutdown Voltage	V

Step 3: Press and hold the display-toggle button for 4 seconds. When the icons blink, the value of each item can be changed by slightly pressing the toggle.

Step 4: To save the value and return to general mode, press and hold the toggle for 4 seconds.

Note! If the machine is left idle for over 30 seconds during setup, it will turn off the backlight and return to general mode automatically.

Note! If user wants to return to the general mode without saving changes, there are two methods:

- (1) Wait for the backlight display to turn off, or,
- (2) By pressing and holding the “Display-toggle key for 10 seconds.

CYBERPOWER GREENPOWER UPS™ TECHNOLOGY

GreenPower UPS™

CyberPower's GreenPower UPS™ Circuit Design is a solution to this "Power Loss." When the Utility Power is operating normally, GreenPower UPS™ works in a Bypass Mode. Our GreenPower UPS™ design conducts power only through the Relay and still provides normal output voltage. Bypassing the transformer reduces power consumption thereby conserving energy and saving money. When the utility power is abnormal the UPS will operate under Battery or AVR Mode. Under this condition GreenPower UPS™ and a traditional UPS would operate about the same. On average utility power operates 88% of the time and the CyberPower GreenPower Technology will work in its money/energy saving Bypass Mode.



TECHNICAL SPECIFICATIONS

Model	PR750ELCDRT1U	PR1000ELCDRT1U
Capacity (VA)	750VA	1000VA
Capacity (Watts)	500	670
Input		
Nominal Input Voltage	220Vac – 240Vac	
Input Voltage Range	160Vac – 290Vac	
Input Frequency Range	50/60 Hz +/- 3 Hz (auto sensing)	
Output		
On Battery Output Voltage	Pure Sine Wave at 230Vac +/- 5%	
On Battery Output Frequency	50 / 60 Hz +/- 0.1 Hz	
Transfer Time (Typical)	4 ms	
Overload Protection	On Utility: Circuit Breaker, On Battery: Internal Current Limiting	
Surge Protection and Filtering		
Lightning / Surge Protection	Yes	
Physical		
Output Receptacles	6	
Dimensions (cm)	1U Rack, 43.3 x 4.4 x49.0	
Weight (kg)	17.6	18
Battery		
Sealed Maintenance Free Lead Acid Battery	6V / 9.0AH x 4	
Hot Swappable External Battery	Yes	
Warning Diagnostics		
Indicators	Power On, LCD Display (Using Battery, AVR, Load Level, Battery Level)	
Audible Alarms	On Battery, Low Battery, Overload	
Environmental		
Operating Temperature	32°F to 104°F (0°C to 40°C)	
Operating Relative Humidity	0 to 95% Non-Condensing	
Communication		
PowerPanel® Business Software	Windows 98/ME/NT/2000/XP, Vista	
Management		
Self-Test	Manual Self-Test	
Auto-Charger/ Auto-Restart	Yes	
COM/ Built-in USB Interface	Yes	
SNMP/ HTTP Network Slot	Optional	